

RH Design

fiyat listesi'18
price list







PH DESIGN has been established in 2006. Produced stainless steel decorative building products. It has been investing with emphasis on R&D studies. Ph Design meet the demands with the goal of leadership in quality, service and innovations, with a rich variety of products and network of dealers in foreign and domestic markets. Meeting the demands with the goal of leadership in sector quality, service and innovations, with a rich variety products and network of dealers in foreign and domestic markets by the firm.

With high –value product structure and using the latest technology, design of molds gives form to the stainless steel.

Our company has been closely monitoring today trend and technology with taking its signature to each design and each year go on its way to becoming strong brand.

Changes Bathrooms and kitchens chemistry with modern, minimalist and rich design.

2006 yılında kurulan PH DİZAYN paslanmaz çelik dekoratif duvar kaplama ürünleri üretiminde Ar-Ge çalışmalarına önem vererek müşteri ve pazar taleplerini gözeterek yatırımlarını gerçekleştirmektedir.

Kalite, hizmet ve yenilikçilikte sektör liderliği hedefi ile çalışmalarını sürdüren Ph Dizayn gerek yurtdışı pazarı gerekse iç pazar bayi ağı ile değişen talepleri sürekli yenilenen zengin ürün portföyü ile karşılamaktadır.

Yüksek katma değer sağlayan yenilikçi ürün yapısı ile gelişen son teknolojiyi kullanarak kalıp üretimleri ile paslanmaz çeliğe şekil ve boyut kazandırmaktadır. Teknolojiyi ve günümüz trendlerini takip eden yenilikçi yaklaşımı ve kalıp teknolojisine yaptığı yatırımı ile her tasarımına kendi imzasını atarak her geçen yıl güçlü bir marka olma yolunda güvenle ilerlemektedir.

Güvenilirlik, yetenek ve kalite zemininde ilerleyen PH DİZAYN modern, minimalist ve zengin dizaynı ile banyo ve mutfakların kimyasını değiştirmek konusunda oldukça iddialıdır.



Mimari projeleriniz için neden PH Dizayn duş kanalları?

- ✓ Patentli contasız sistem ile %100 su sızdırmazlık garantisi, Dünyada ilk ve TEK !
- ✓ Patentli V Cutting teknolojisi kullanılarak üretilen Slim ve Artflow serilerinde kapak detayında keskin hat bitişi ile seramikler ile mükemmel derzsiz birleşim.
- ✓ Farklı ebat ve renk alternatifleri ile mimari çözümler
- ✓ 6 farklı sifon alternatifi, yüksek tahliye kapasitesi ve S sifon yapısı ile kokusuz banyolar !
- ✓ Her türlü proje alanlara uygunluk beton ve şap üzerinde izolasyon kilitlemesi sağlayan sistemler ile dar alanlara uygun compact sifon ve minimum şap yüksekliklerine uyumlu sifon tipleri ile projenizmekanik birimleri için mükemmel çözümler.

Why you choose ph design drainage systems?

- ✓ First and unique design all over the world with patented without gasket systems provide %100 waterproof.
- ✓ With patented V Cutting technologies sharp finishing for cover provide perfect finish with ceramic tiles.
- ✓ With different size and color options, architectural solutions.
- ✓ With 6 different siphon alternatives, high drain capacity and S siphon prevent odor system.
- ✓ Minimum height siphon alternatives, compact siphon for small shower area.

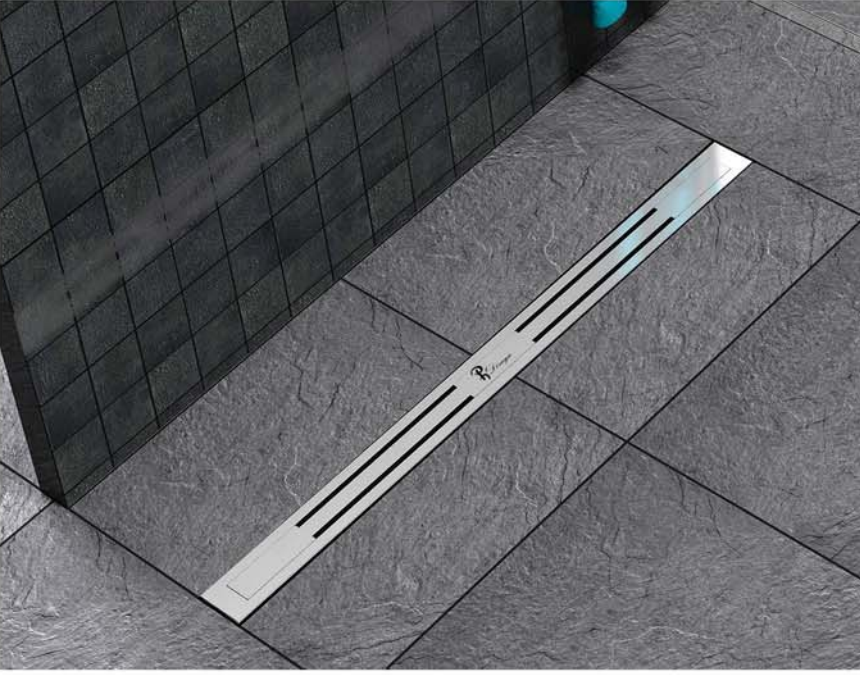

PH SLIM SAYFA : 7 / 20

- ✓40 cm , 60 cm , 80 cm , 120 cm uzunluk alternatifi.
- ✓4 cm genişlik
- ✓6 farklı sifon alternatifi
- ✓4 farklı renk alternatifi
- ✓Patentli contasız sistem ile %100 su sızdırmazlık garantisi.
- ✓Patentli V Cutting teknolojisi ile mükemmel seramik birleşimi.

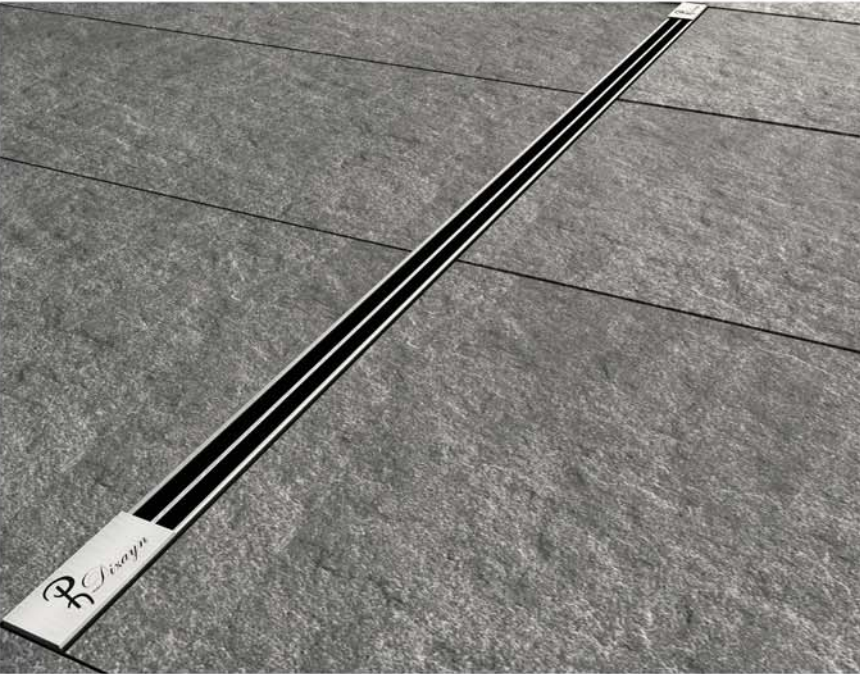

PH BALCONY & TERRACE SAYFA : 21 / 24

- ✓60 cm , 100 cm , 200 cm , 300 cm uzunluk alternatifi.
- ✓2,5 cm genişlik
- ✓6 farklı sifon alternatifi

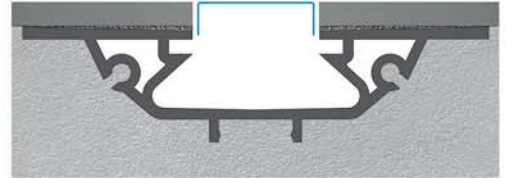

PH ART FLOW SAYFA : 25 / 38

- ✓40 cm , 50 cm , 60 cm , 80 cm , 120 cm uzunluk alternatifi.
- ✓6 cm genişlik
- ✓6 farklı sifon alternatifi
- ✓4 farklı renk alternatifi
- ✓Patentli contasız sistem ile %100 su sızdırmazlık garantisi.
- ✓Patentli V Cutting teknolojisi ile mükemmel seramik birleşimi.





PH PREMIUM SAYFA : 39 / 58

- ✓30 cm , 40 cm , 50 cm , 60 cm , 70 cm , 80 cm , 90 cm , 100 cm , 120 cm uzunluk alternatifi.
- ✓6 cm genişlik
- ✓6 farklı sifon alternatifi
- ✓4 farklı renk alternatifi
- ✓Patentli contasız sistem ile %100 su sızdırmazlık garantisi.



PH PRODRAIN SAYFA : 59 / 72

- ✓Prodrain invisible serisi ile görünmez gider sistemine sahip yenilikçi ürünler.
- ✓30 cm , 40 cm , 50 cm , 60 cm , 70 cm , 80 cm , 90 cm uzunluk alternatifi.
- ✓5,5 cm genişlik
- ✓6 farklı sifon alternatifi
- ✓4 farklı renk alternatifi
- ✓Patentli contasız sistem ile %100 su sızdırmazlık garantisi.



PH BASIC SAYFA : 73 / 74

- ✓30 cm , 40 cm , 50 cm , 60 cm , 70 cm , 80 cm , 90 cm uzunluk alternatifi.
- ✓6 cm genişlik

YER SÜZGEÇLERİ SAYFA : 75 / 82

- ✓10 x 10 cm , 15 x 15 cm ebat seçenekli
- ✓4 farklı sifon alternatifi
- ✓3 farklı renk alternatifi



DIAMOND SHINE syf: 85

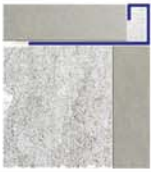

PROFIX F syf: 86



PROFIX Q syf: 87



PROFIX QE syf: 88



PROFIX D syf: 89



PROFIX DE syf: 90



PROFIX L syf: 91



PROFIX LE syf: 92



PROFIX U syf: 93



PROFIX UE syf: 94



PROFIX C syf: 95

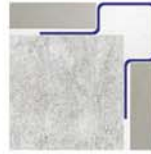

PROFIX UT syf: 96



PROFIX 45 syf: 97

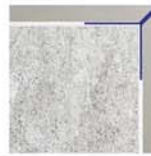

PROFIX V syf: 98



PROFIX R syf: 99



PROFIX S syf: 100



PROFIX KOT K syf: 101



PROFIX KOT Z syf: 102

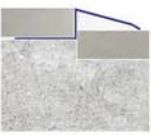

PROFIX KOT N syf: 103



PROFIX T syf: 104



PROFIX G syf: 105



PROFIX E1 syf: 106



PROFIX Y syf: 107



PROFIX E2 syf: 108



PROFIX E3 syf: 109



PROFIX E4 syf: 110



PROFIX KOT A syf: 111

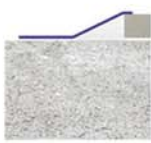

PROFIX LR syf: 112



PROFIX B syf: 113



PROFIX BB syf: 114



PROFIX QA syf: 115



PROFIX DK syf: 116



LINEAR syf: 119



DIAMOND X syf: 121



DIAMOND TILE syf: 123



DIAMOND FORM syf: 124



DIAMOND ART syf: 125



DIAMOND LUX syf: 126



DIAMOND DESIGN syf: 127



DIAMOND DESIGN syf: 127



DIAMOND SHINE syf: 128



OTTOMAN syf: 129



OTTOMAN DIAMOND syf: 130



OTTOMAN DIAMOND syf: 131



LINEAR X syf: 132



LINEAR S syf: 132



3d STAR W syf: 135



3d STAR syf: 135



3d ANGLE syf: 135



CAPELLA syf: 136



VENÜS syf: 137



BUTTERFLY syf: 137



FLOWER syf: 138



INFINITY R syf: 139



INFINITY D syf: 140



KASABLANKA S DIAMOND syf: 141



KASABLANKA 2S DIAMOND syf: 142



KASABLANKA 3S DIAMOND syf: 142



LILYUM S DIAMOND syf: 143



KARDELEN syf: 144



KRIZANTEM syf: 144



AÇELYA DIAMOND syf: 145



MIMOZA DIAMOND syf: 145



DRAGON syf: 146



PH SLIM

Duř kanallarında en ince tasarım PH Slim... Ürünün görsel zerafetiyle banyo ayrı bir keyif... PH Slim serisi 3.5 cm yüzey genişliđi sunan son teknoloji üretim ile ıslak mekanlara yepyeni tasarım seçenekleri sunuyor. PH Slim yüzey genişliđi [3.5cm] slim sifon yüksekliđi [5cm]'ne sahip olan PH Slim aynı zamanda 3 farklı dekoratif renklerde üretilen ızgara çerçevesi ve tüm seramik yüzeyler ile mükemmel kombinasyon sağlıyor. Sahip olduđu yahtım eteđi ile drenaj için mükemmel bir çözüm sunuyor. 360 derece döner sifon ile kolay montaj sağlıyor. En önemli özelliklerinden biri de ızgara çerçevesi, yükseklik ayar seti ve süzgecin aynı parçada tasarım olarak sunulması.



304

stainles
steel

51l/min



+
+
easy
to clean



odor prevent
system



360°
base
rotation



60
mm

Ø 50
output



easy
assembling

Ultra slim shower channel PH Slim... With 4 cm width option, 360 degree siphon alternatives, 6 cm total height. Produced 3 different colour options,height adjustment, the system preven odor, insulation.

SLIM

DRAINLINE

PH Dizayn

Uygulama Kesit :

1. Döşeme Betonu / Covering Concrete
2. Tesviye Betonu / Levelling Concrete
3. Ph Dizayn Butil Bant / ph design Butil Bant
4. İzolasyon Katmanı / İnsulation Layer
5. Yapıştırıcı / Adhesive
6. Kaplama Malzemesi / Covering

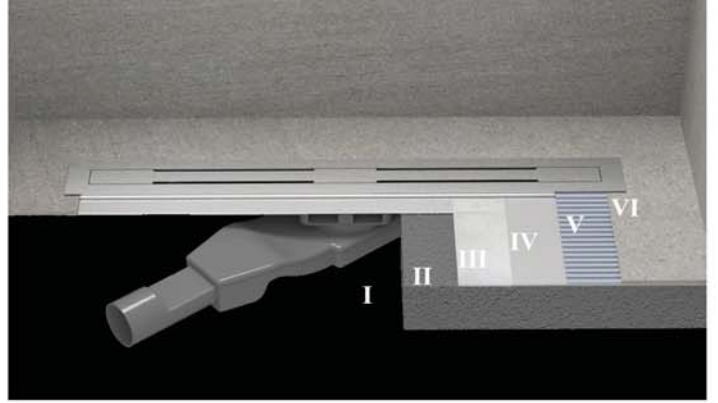

Sifon Tipi : S01

Kapak (1.5 mm kalınlık) / Top cover (1.5 mm)

Yükseklik Ayar Çerçevesi(2.5 mm) /Final height adjustment Frame(2.5 mm)

Yükseklik Ayar Vidası / Height Adjustment Screw

Saç Tutucu Süzgeç / Hair Holder

Yalıtım Etekli Ana Gövde / Insulated Main Body

Patentli Contasız Bağlantı Parçası / Patented Without Gasket Part

360° Döner Sifon S01 / 360° Degree Rotating Flusher

Yükseklik Ayar Parçası / Height Adjustment Kit

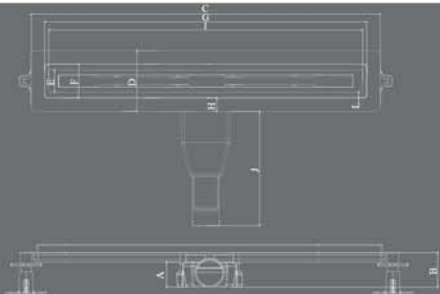

	40	60	80	120
A	4.3	4.3	4.3	4.3
B	6	6	6	6
C	45	65	85	125
D	11.3	11.3	11.3	11.3
E	4.1	4.1	4.1	4.1
F	6.3	6.3	6.3	6.3
G	40	60	80	120
H	2.5	2.5	2.5	2.5
I	38.4	58.4	78.4	118.4
J	21.3	21.3	21.3	21.3
K	0.8	0.8	0.8	0.8
L	1.1	1.1	1.1	1.1

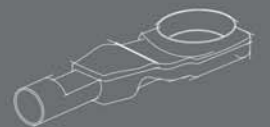

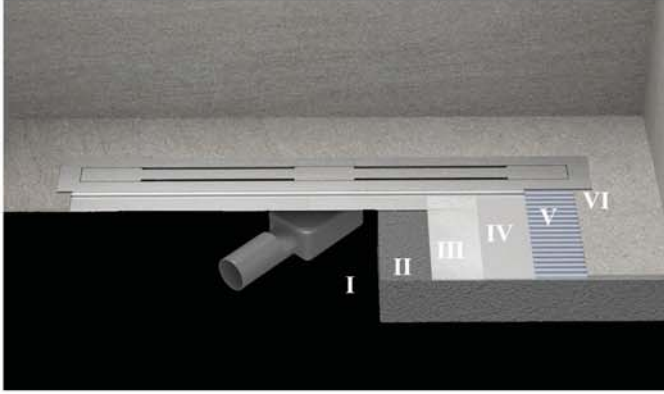

Uygulama Kesit :

1. Döşeme Betonu / Covering Concrete
2. Tesviye Betonu / Levelling Concrete
3. Ph Dizayn Butil Bant / ph design Butil Bant
4. İzolasyon Katmanı / Insulation Layer
5. Yapıştırıcı / Adhesive
6. Kaplama Malzemesi / Covering

Sifon Tipi : S02

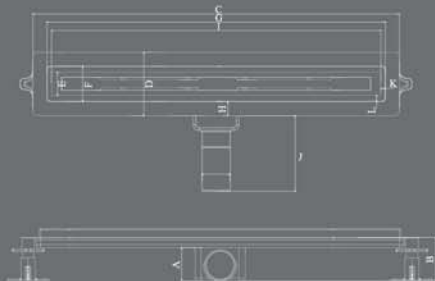

	40	60	80	120
A	5	5	5	5
B	7	7	7	7
C	45	65	85	125
D	11.3	11.3	11.3	11.3
E	4.1	4.1	4.1	4.1
F	6.3	6.3	6.3	6.3
G	40	60	80	120
H	2.5	2.5	2.5	2.5
I	38.4	58.4	78.4	118.4
J	13.5	13.5	13.5	13.5
K	0.8	0.8	0.8	0.8
L	1.1	1.1	1.1	1.1

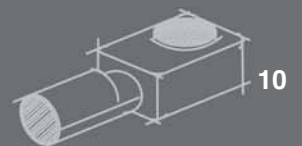

SLIM

DRAINLINE

PH Dizayn

Uygulama Kesit :

1. Döşeme Betonu / Covering Concrete
2. Tesviye Betonu / Levelling Concrete
3. Ph Dizayn Butil Bant / ph design Butil Bant
4. İzolasyon Katmanı / Insulation Layer
5. Yapıştırıcı / Adhesive
6. Kaplama Malzemesi / Covering

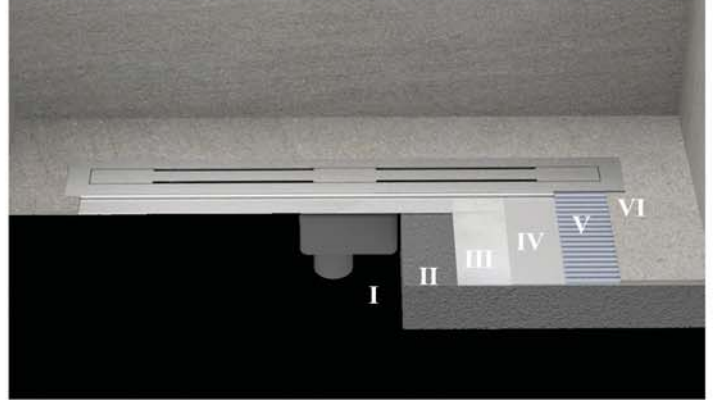

Sifon Tipi : S03

Kapak (1.5 mm kalınlık) / Top cover (1.5 mm)

Yükseklik Ayar Çerçevesi(2.5 mm) /Final height adjustment Frame(2.5 mm)

Yükseklik Ayar Vidası / Height Adjustment Screw

Saç Tutucu Süzgeç / Hair Holder

Yalıtım Etekli Ana Gövde / Insulated Main Body

Patentli Contasız Bağlantı Parçası / Patented Without Gasket Part

360° Döner Sifon S03 / 360° Degree Rotating Flusher

Yükseklik Ayar Parçası / Height Adjustment Kit

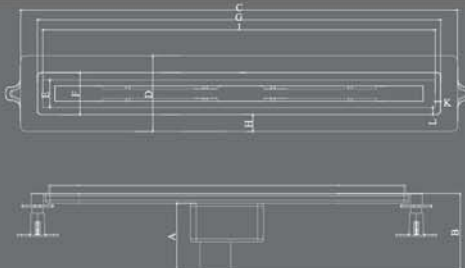
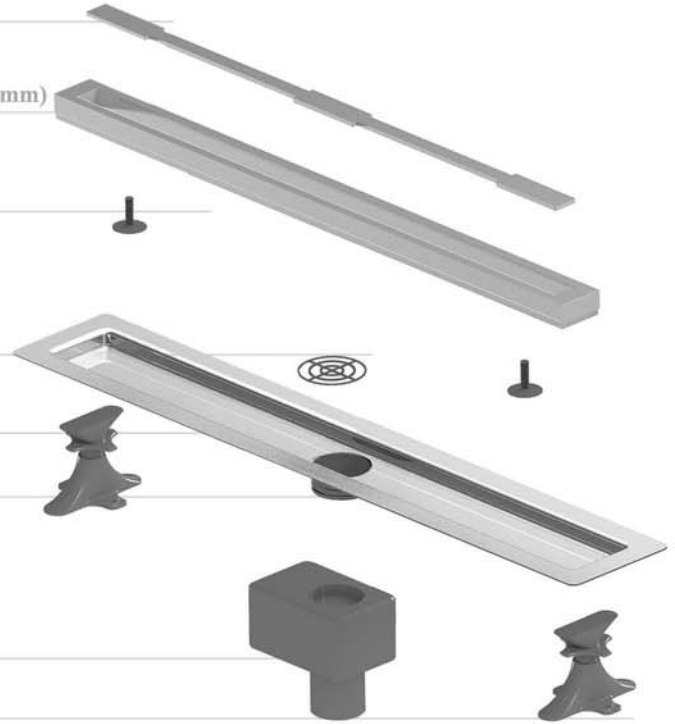

	40	60	80	120
A	11	11	11	11
B	12.6	12.6	12.6	12.6
C	45	65	85	125
D	11.3	11.3	11.3	11.3
E	4.1	4.1	4.1	4.1
F	6.3	6.3	6.3	6.3
G	40	60	80	120
H	2.5	2.5	2.5	2.5
I	38.4	58.4	78.4	118.4
K	0.8	0.8	0.8	0.8
L	1.1	1.1	1.1	1.1

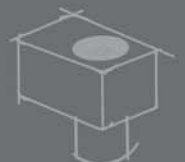

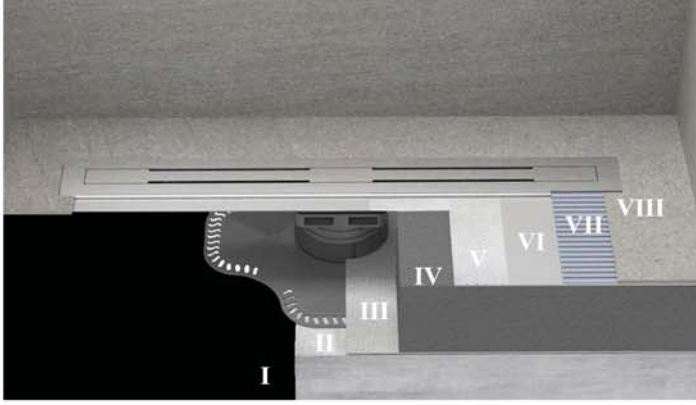

Uygulama Kesit :

1. Beton Katmanı / Concrete Layer
2. İzolasyon Katmanı / Insulation Layer
3. Döşeme Betonu / Covering Concrete
4. Tesviye Betonu / Levelling Concrete
5. Ph Dizayn Butil Bant / ph design Butil Bant
6. İzolasyon Katmanı / Insulation Layer
7. Yapıştırıcı / Adhesive
8. Kaplama Malzemesi / Covering

Sifon Tipi : S08

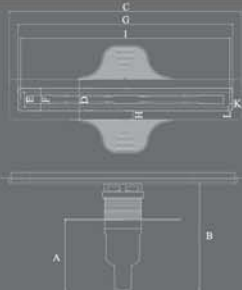
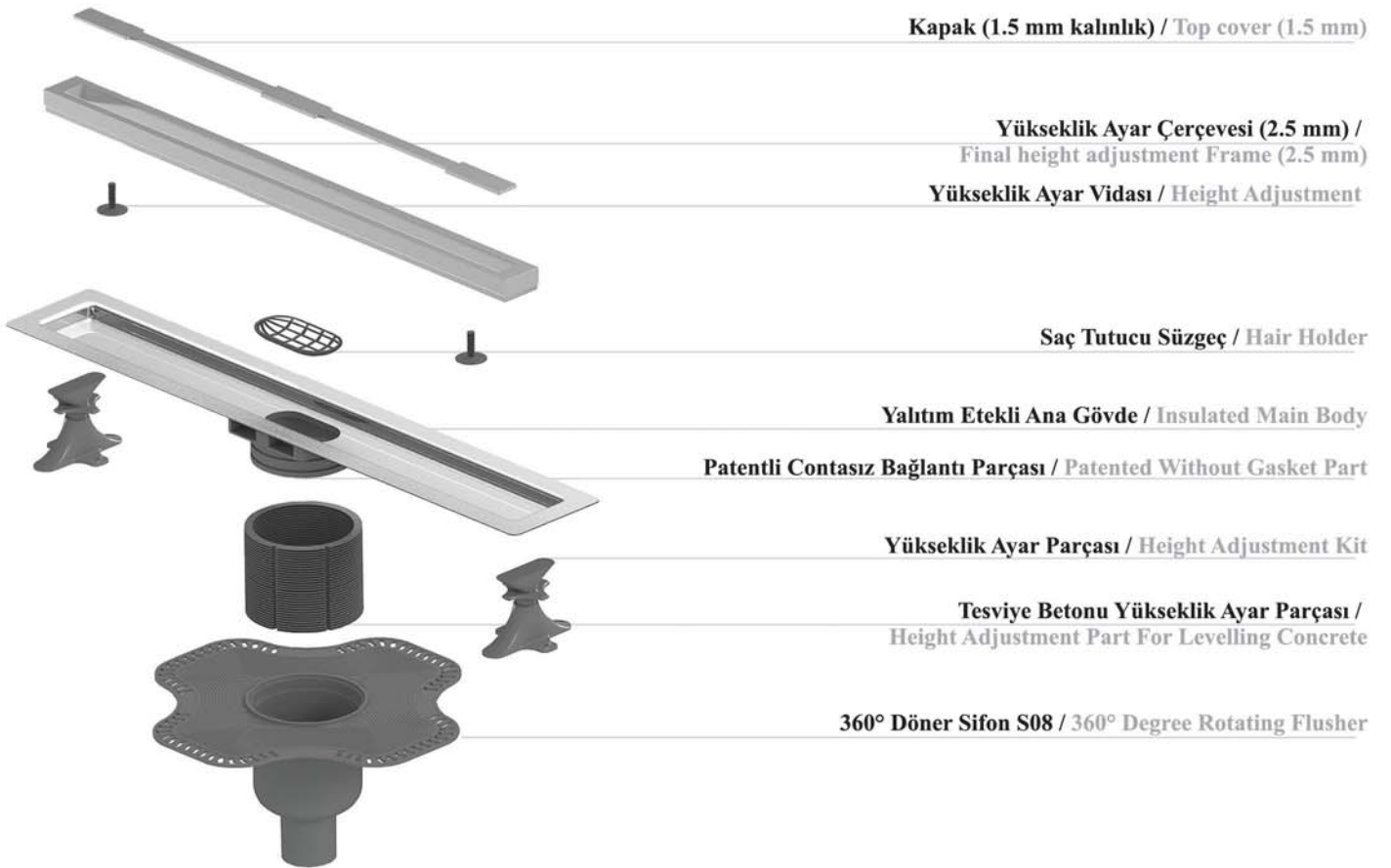

	40	60	80	120
A	16	16	16	16
B	AYARLANABİLİR	AYARLANABİLİR	AYARLANABİLİR	AYARLANABİLİR
C	45	65	85	125
D	11.3	11.3	11.3	11.3
E	4.1	4.1	4.1	4.1
F	6.3	6.3	6.3	6.3
G	40	60	80	120
H	2.5	2.5	2.5	2.5
I	38.4	58.4	78.4	118.4
J	9.4	9.4	9.4	9.4
K	0.8	0.8	0.8	0.8
L	1.1	1.1	1.1	1.1

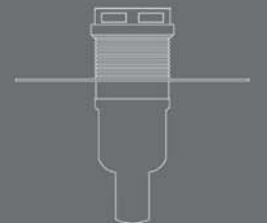

SLIM

DRAINLINE

Ph Dizayn

Uygulama Kesit :

1. Döşeme Betonunu / Covering Concrete
2. Tesviye Betonunu / Levelling Concrete
3. Ph Dizayn Butil Bant / ph design Butil Bant
4. İzolasyon Katmanı / Insulation Layer
5. Yapıştırıcı / Adhesive
6. Kaplama Malzemesi / Covering

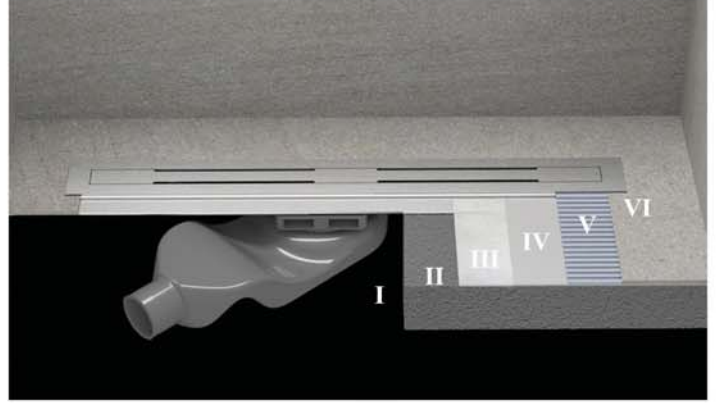

Sifon Tipi : S10

Kapak (1.5 mm kalınlık) / Top cover (1.5 mm)

Yükseklik Ayar Çerçevesi (2.5 mm)/Final height adjustment Frame (2.5 mm)

Yükseklik Ayar Vidası / Height Adjustment Screw

Saç Tutucu Süzgeç / Hair Holder

Yalıtım Etekli Ana Gövde / Insulated Main Body

Patentli Contasız Bağlantı Parçası / Patented Without Gasket Part

360° Döner Sifon S10 / 360° Degree Rotating Flusher

Yükseklik Ayar Parçası / Height Adjustment Kit

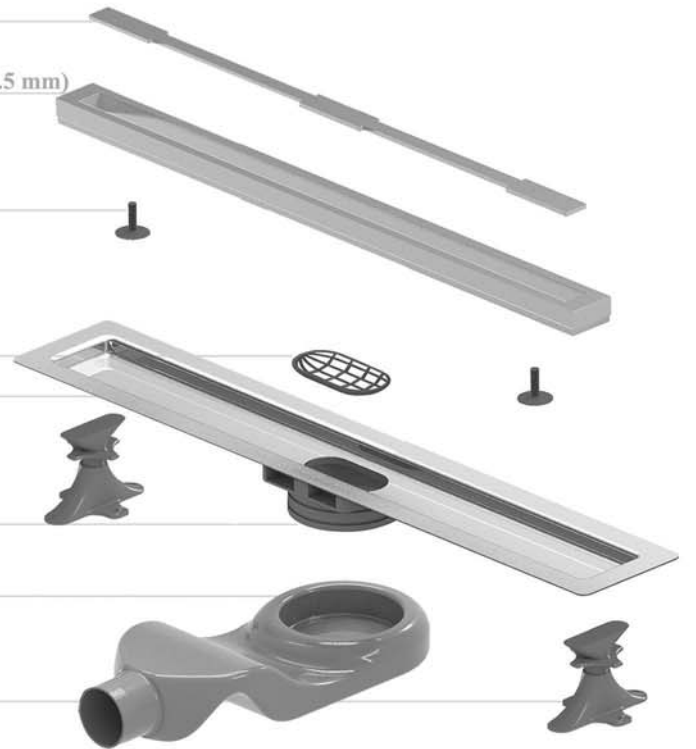

	40	60	80	120
A	4.3	4.3	4.3	4.3
B	6	6	6	6
C	45	65	85	125
D	11.3	11.3	11.3	11.3
E	4.1	4.1	4.1	4.1
F	6.3	6.3	6.3	6.3
G	40	60	80	120
H	2.5	2.5	2.5	2.5
I	38.4	58.4	78.4	118.4
J	21.3	21.3	21.3	21.3
K	0.8	0.8	0.8	0.8
L	1.1	1.1	1.1	1.1



Uygulama Kesit :

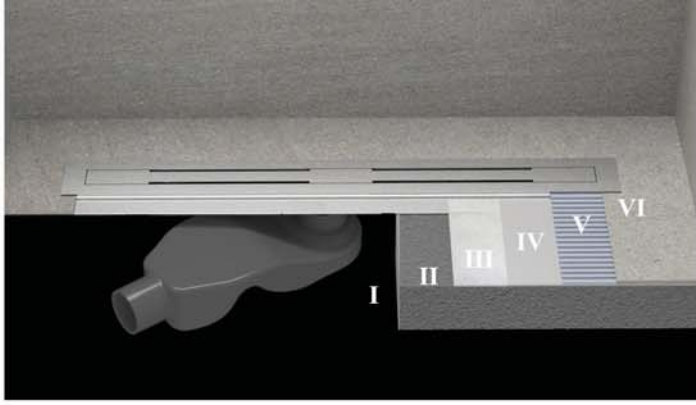

1. Döşeme Betonu / Covering Concrete
2. Tesviye Betonu / Levelling Concrete
3. Ph Dizayn Butil Bant / ph design Butil Bant
4. İzolasyon Katmanı / Insulation Layer
5. Yapıştırıcı / Adhesive
6. Kaplama Malzemesi / Covering

Sifon Tipi : S11

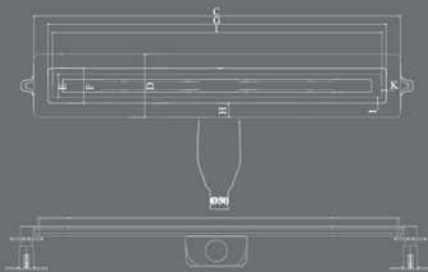
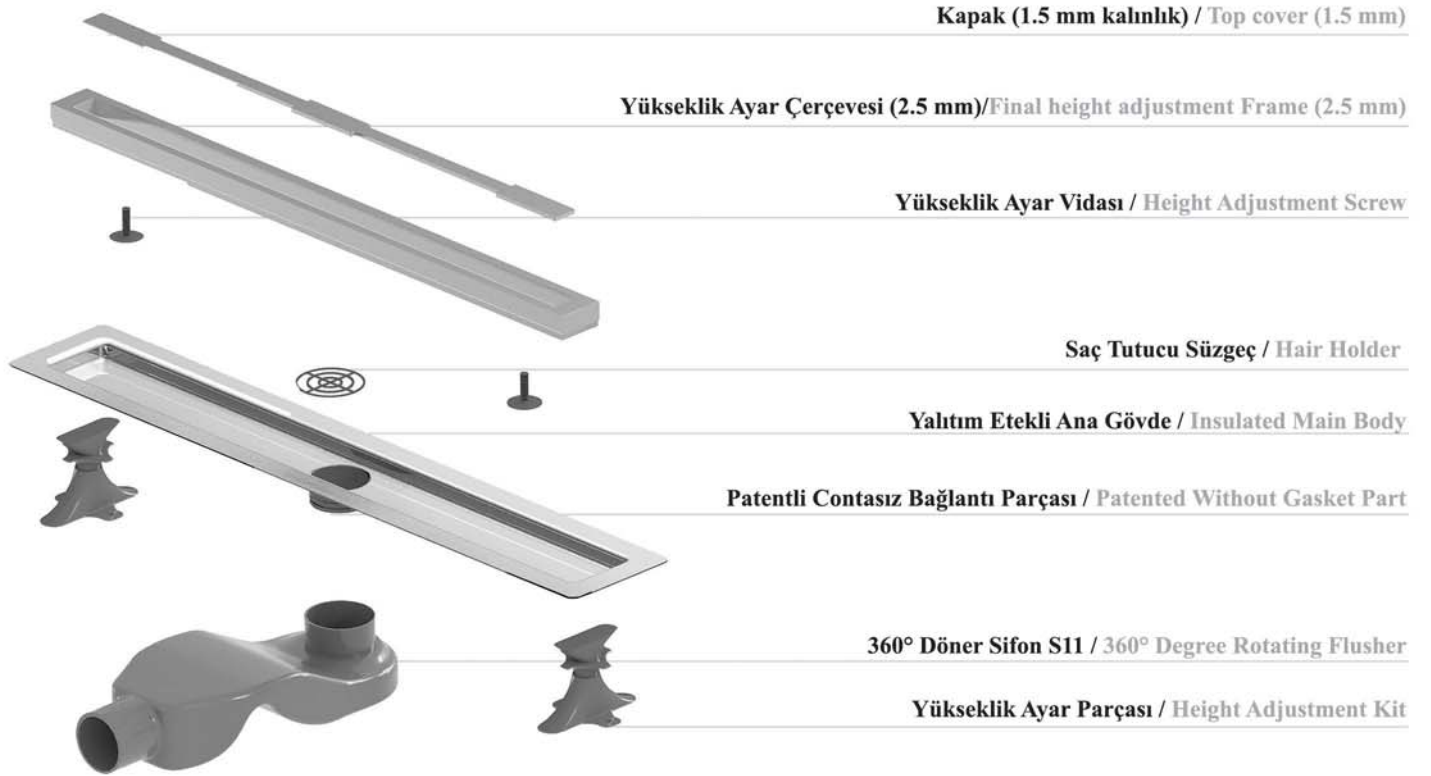

	40	60	80	120
A	5	5	5	5
B	7	7	7	7
C	45	65	85	125
D	11.3	11.3	11.3	11.3
E	4.1	4.1	4.1	4.1
F	6.3	6.3	6.3	6.3
G	40	60	80	120
H	2.5	2.5	2.5	2.5
I	38.4	58.4	78.4	118.4
J	13.5	13.5	13.5	13.5
K	0.8	0.8	0.8	0.8
L	1.1	1.1	1.1	1.1



SLIM
ELEGANT

DRAINLINE

R Dizayn

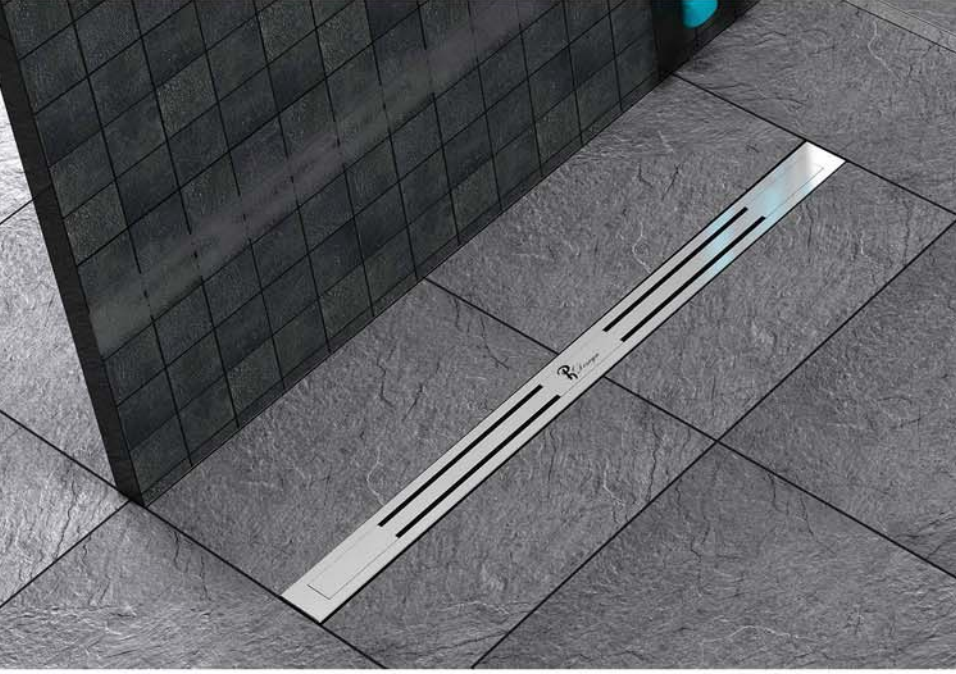

PH DESIGN

Slim serisi ile duş alanlarına modern , estetik ve kullanışlı çözümler sunuyor. Hemzemin uygulama karo ile bütünleşerek engelsiz banyolar yaratıyor. Yeni teknolojiyi kullanarak PATENTLİ CONTASIZ sistem ile sızdırmalıkta standartları yeniden belirleniyor. **Slim serisi ürünler;**
-Yalıtım bitimli kaynaksız yekpare gövde, şap yüksekliğini için yükseklik ayar seti, farklı montaj yükseklikleri ve drenaj kapasiteleri ile projelere uygun alternatif mekanik çözümler sunan, 360 derece dönebilen yüksek drenaj kapasiteli koku feramatürlü S sifon, saç tutucu, 20 cm genişliğinde bütül bant, uygulama sonrası oluşabilecek kot farklılıklarını önleyen yükseklik ayar setini uygulama kolaylığı sağlayacak şekilde standardize ederek. Tek parça ürün olarak birleştiriyor ve kullanıcılara kolay montaj avantajı sunuyor.

EBAT Size	Inox Satinox	Inox Ayna Mirror	Altın Ayna Gold	Bakır Ayna Bronze
40 cm	DS 040 01 07 S01	DS 040 00 07 S01	DS 040 20 07 S01	DS 040 30 07 S01
60 cm	DS 060 01 07 S01	DS 060 00 07 S01	DS 060 20 07 S01	DS 060 30 07 S01
80 cm	DS 080 01 07 S01	DS 080 00 07 S01	DS 080 20 07 S01	DS 080 30 07 S01
120 cm	DS 120 01 07 S01	DS 120 00 07 S01	DS 120 20 07 S01	DS 120 30 07 S01



Sifon Tipi : S01

EBAT Size	Inox Satinox	Inox Ayna Mirror	Altın Ayna Gold	Bakır Ayna Bronze
40 cm	DS 040 01 07 S02	DS 040 00 07 S02	DS 040 20 07 S02	DS 040 30 07 S02
60 cm	DS 060 01 07 S02	DS 060 00 07 S02	DS 060 20 07 S02	DS 060 30 07 S02
80 cm	DS 080 01 07 S02	DS 080 00 07 S02	DS 080 20 07 S02	DS 080 30 07 S02
120 cm	DS 120 01 07 S02	DS 120 00 07 S02	DS 120 20 07 S02	DS 120 30 07 S02



Sifon Tipi : S02

S01

h : 60 mm
Debi: 51 lt/dk - Flow: 51 lt/min
Kokusuz / Odor free



S02

h : 70 mm
Debi: 48 lt/dk - Flow: 48 lt/min
Kokusuz / Odor free



S03

h : 30/80 mm
Karot ø: 120mm -Care Drill Diameter ø: 120mm
Kokusuz / Odor free



EBAT Size	Inox Satinox	Inox Ayna Mirror	Altın Ayna Gold	Bakır Ayna Bronze
40 cm	DS 040 01 07 S10 155 \$	DS 040 00 07 S10 183 \$	DS 040 20 07 S10 197 \$	DS 040 30 07 S10 217 \$
60 cm	DS 060 01 07 S10 189 \$	DS 060 00 07 S10 216 \$	DS 060 20 07 S10 234 \$	DS 060 30 07 S10 261 \$
80 cm	DS 080 01 07 S10 228 \$	DS 080 00 07 S10 247 \$	DS 080 20 07 S10 262 \$	DS 080 30 07 S10 288 \$
120 cm	DS 120 01 07 S10 308 \$	DS 120 00 07 S10 347 \$	DS 120 20 07 S10 363 \$	DS 120 30 07 S10 399 \$



Sifon Tipi : S10

EBAT Size	Inox Satinox	Inox Ayna Mirror	Altın Ayna Gold	Bakır Ayna Bronze
40 cm	DS 040 01 07 S11 155 \$	DS 040 00 07 S11 183 \$	DS 040 20 07 S11 197 \$	DS 040 30 07 S11 217 \$
60 cm	DS 060 01 07 S11 189 \$	DS 060 00 07 S11 216 \$	DS 060 20 07 S11 234 \$	DS 060 30 07 S11 261 \$
80 cm	DS 080 01 07 S11 228 \$	DS 080 00 07 S11 247 \$	DS 080 20 07 S11 262 \$	DS 080 30 07 S11 288 \$
120 cm	DS 120 01 07 S11 308 \$	DS 120 00 07 S11 347 \$	DS 120 20 07 S11 363 \$	DS 120 30 07 S11 399 \$



Sifon Tipi : S11

EBAT Size	Inox Satinox	Inox Ayna Mirror	Altın Ayna Gold	Bakır Ayna Bronze
40 cm	DS 040 01 07 S03 140 \$	DS 040 00 07 S03 168 \$	DS 040 20 07 S03 182 \$	DS 040 30 07 S03 200 \$
60 cm	DS 060 01 07 S03 174 \$	DS 060 00 07 S03 201 \$	DS 060 20 07 S03 219 \$	DS 060 30 07 S03 241 \$
80 cm	DS 080 01 07 S03 213 \$	DS 080 00 07 S03 232 \$	DS 080 20 07 S03 247 \$	DS 080 30 07 S03 272 \$
120 cm	DS 120 01 07 S03 293 \$	DS 120 00 07 S03 332 \$	DS 120 20 07 S03 348 \$	DS 120 30 07 S03 383 \$



Sifon Tipi : S03

EBAT Size	Inox Satinox	Inox Ayna Mirror	Altın Ayna Gold	Bakır Ayna Bronze
40 cm	DS 040 01 07 S08 175 \$	DS 040 00 07 S08 203 \$	DS 040 20 07 S08 217 \$	DS 040 30 07 S08 239 \$
60 cm	DS 060 01 07 S08 209 \$	DS 060 00 07 S08 236 \$	DS 060 20 07 S08 254 \$	DS 060 30 07 S08 279 \$
80 cm	DS 080 01 07 S08 248 \$	DS 080 00 07 S08 267 \$	DS 080 20 07 S08 282 \$	DS 080 30 07 S08 310 \$
120 cm	DS 120 01 07 S08 328 \$	DS 120 00 07 S08 367 \$	DS 120 20 07 S08 383 \$	DS 120 30 07 S08 421 \$



Sifon Tipi : S08

S08

h : 30/80 mm
Karot ø: 110 mm - Care Drill Diameter ø: 110 mm
Kokusuz / Odor free



S10

h : 60 mm
Debi: 60 lt/dk - Flow: 60 lt/min
Kokusuz / Odor free



S11

h : 70 mm
Debi: 60 lt/dk - Flow: 60 lt/min
Kokusuz / Odor free





PH DESIGN

Slim serisi ile duř alanlarına modern , estetik ve kullanışlı çözümler sunuyor. Hemzemin uygulama karo ile bütünleşerek engelsiz banyolar yaratıyor. Yeni teknolojiyi kullanarak PATENTLİ CONTASIZ sistem ile sızdırmalıkta standartları yeniden belirleniyor. **Slim serisi ürünler;**
-Yalıtım bitimli kaynaksız yekpare gövde, şap yüksekliğini için yükseklik ayar seti, farklı montaj yükseklikleri ve drenaj kapasiteleri ile projelere uygun alternatif mekanik çözümler sunan, 360 derece dönebilen yüksek drenaj kapasiteli koku fermatürlü S sifon, saç tutucu, 20 cm genişliğinde bütül bant, uygulama sonrası oluşabilecek kot farklılıklarını önleyen yükseklik ayar setini uygulama kolaylığı sağlayacak şekilde standardize ederek. Tek parça ürün olarak birleştiriyor ve kullanıcılara kolay montaj avantajı sunuyor.

EBAT Size	Inox Satinox	Inox Ayna Mirror	Altın Ayna Gold	Bakır Ayna Bronze				
40 cm	DS 040 01 08 S01	140 \$	DS 040 00 08 S01	168 \$	DS 040 20 08 S01	182 \$	DS 040 30 08 S01	200 \$
60 cm	DS 060 01 08 S01	174 \$	DS 060 00 08 S01	201 \$	DS 060 20 08 S01	219 \$	DS 060 30 08 S01	241 \$
80 cm	DS 080 01 08 S01	213 \$	DS 080 00 08 S01	232 \$	DS 080 20 08 S01	247 \$	DS 080 30 08 S01	272 \$
120 cm	DS 120 01 08 S01	293 \$	DS 120 00 08 S01	332 \$	DS 120 20 08 S01	348 \$	DS 120 30 08 S01	383 \$



Sifon Tipi : S01

EBAT Size	Inox Satinox	Inox Ayna Mirror	Altın Ayna Gold	Bakır Ayna Bronze				
40 cm	DS 040 01 08 S02	140 \$	DS 040 00 08 S02	168 \$	DS 040 20 08 S02	182 \$	DS 040 30 08 S02	200 \$
60 cm	DS 060 01 08 S02	174 \$	DS 060 00 08 S02	201 \$	DS 060 20 08 S02	219 \$	DS 060 30 08 S02	241 \$
80 cm	DS 080 01 08 S02	213 \$	DS 080 00 08 S02	232 \$	DS 080 20 08 S02	247 \$	DS 080 30 08 S02	272 \$
120 cm	DS 120 01 08 S02	293 \$	DS 120 00 08 S02	332 \$	DS 120 20 08 S02	348 \$	DS 120 30 08 S02	383 \$



Sifon Tipi : S02

S01

h : 60 mm
Debi: 51 lt/dk - Flow: 51 lt/min
Kokusuz / Odor free



S02

h : 70 mm
Debi: 48 lt/dk - Flow: 48 lt/min
Kokusuz / Odor free



S03

h : 30/80 mm
Karot ø: 120mm -Care Drill Diameter ø: 120mm
Kokusuz / Odor free



EBAT Size	Inox Satinox	Inox Ayna Mirror	Altın Ayna Gold	Bakır Ayna Bronze
40 cm	DS 040 01 08 S10 155 \$	DS 040 00 08 S10 183 \$	DS 040 20 08 S10 197 \$	DS 040 30 08 S10 217 \$
60 cm	DS 060 01 08 S10 189 \$	DS 060 00 08 S10 216 \$	DS 060 20 08 S10 234 \$	DS 060 30 08 S10 261 \$
80 cm	DS 080 01 08 S10 228 \$	DS 080 00 08 S10 247 \$	DS 080 20 08 S10 262 \$	DS 080 30 08 S10 288 \$
120 cm	DS 120 01 08 S10 308 \$	DS 120 00 08 S10 347 \$	DS 120 20 08 S10 363 \$	DS 120 30 08 S10 399 \$



Sifon Tipi : S10

EBAT Size	Inox Satinox	Inox Ayna Mirror	Altın Ayna Gold	Bakır Ayna Bronze
40 cm	DS 040 01 08 S11 155 \$	DS 040 00 08 S11 183 \$	DS 040 20 08 S11 197 \$	DS 040 30 08 S11 217 \$
60 cm	DS 060 01 08 S11 189 \$	DS 060 00 08 S11 216 \$	DS 060 20 08 S11 234 \$	DS 060 30 08 S11 261 \$
80 cm	DS 080 01 08 S11 228 \$	DS 080 00 08 S11 247 \$	DS 080 20 08 S11 262 \$	DS 080 30 08 S11 288 \$
120 cm	DS 120 01 08 S11 308 \$	DS 120 00 08 S11 347 \$	DS 120 20 08 S11 363 \$	DS 120 30 08 S11 399 \$



Sifon Tipi : S11

EBAT Size	Inox Satinox	Inox Ayna Mirror	Altın Ayna Gold	Bakır Ayna Bronze
40 cm	DS 040 01 08 S03 140 \$	DS 040 00 08 S03 168 \$	DS 040 20 08 S03 182 \$	DS 040 30 08 S03 200 \$
60 cm	DS 060 01 08 S03 174 \$	DS 060 00 08 S03 201 \$	DS 060 20 08 S03 219 \$	DS 060 30 08 S03 241 \$
80 cm	DS 080 01 08 S03 213 \$	DS 080 00 08 S03 232 \$	DS 080 20 08 S03 247 \$	DS 080 30 08 S03 272 \$
120 cm	DS 120 01 08 S03 293 \$	DS 120 00 08 S03 332 \$	DS 120 20 08 S03 348 \$	DS 120 30 08 S03 383 \$



Sifon Tipi : S03

EBAT Size	Inox Satinox	Inox Ayna Mirror	Altın Ayna Gold	Bakır Ayna Bronze
40 cm	DS 040 01 08 S08 175 \$	DS 040 00 08 S08 203 \$	DS 040 20 08 S08 217 \$	DS 040 30 08 S08 239 \$
60 cm	DS 060 01 08 S08 209 \$	DS 060 00 08 S08 236 \$	DS 060 20 08 S08 254 \$	DS 060 30 08 S08 279 \$
80 cm	DS 080 01 08 S08 248 \$	DS 080 00 08 S08 267 \$	DS 080 20 08 S08 282 \$	DS 080 30 08 S08 310 \$
120 cm	DS 120 01 08 S08 328 \$	DS 120 00 08 S08 367 \$	DS 120 20 08 S08 383 \$	DS 120 30 08 S08 421 \$



Sifon Tipi : S08

S08

h : 30/80 mm
Karat ø: 110 mm - Care Drill Diameter ø: 110 mm
Kokusuz / Odor free



S10

h : 60 mm
Debi: 60 lt/dk - Flow: 60 lt/min
Kokusuz / Odor free



S11

h : 70 mm
Debi: 60 lt/dk - Flow: 60 lt/min
Kokusuz / Odor free



SLIM
TRENDY

DRAINLINE

PH Design

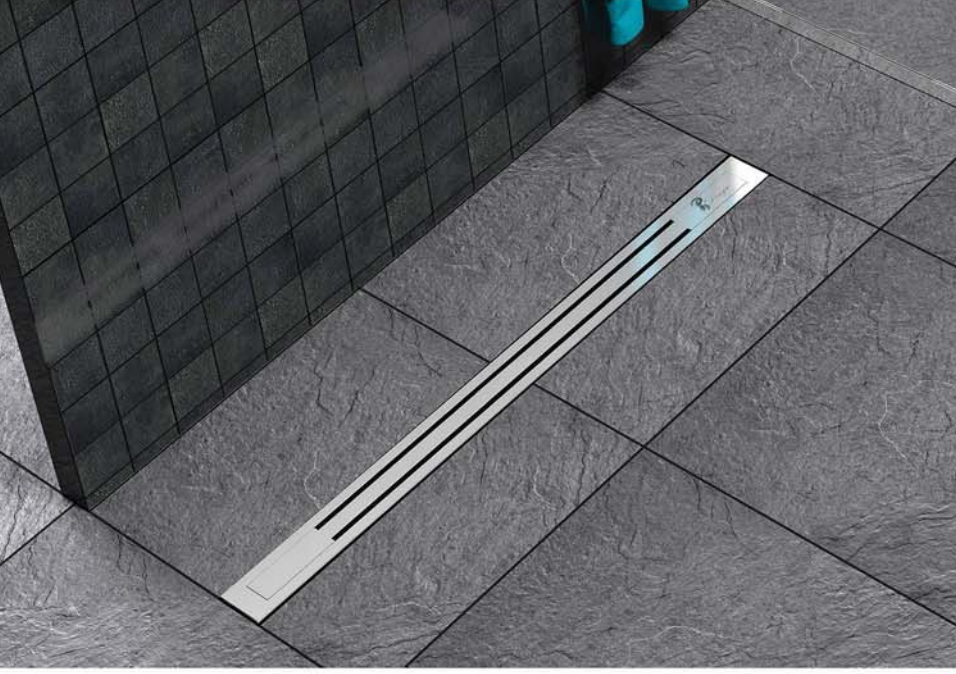

PH DESIGN

Slim serisi ile duş alanlarına modern , estetik ve kullanışlı çözümler sunuyor. Hemzemin uygulama karo ile bütünleşerek engelsiz banyolar yaratıyor. Yeni teknolojiyi kullanarak PATENTLİ CONTASIZ sistem ile sızdırmalıkta standartları yeniden belirleniyor. **Slim serisi ürünler;**
-Yalıtım bitimli kaynaksız yekpare gövde, şap yüksekliğini için yükseklik ayar seti, farklı montaj yükseklikleri ve drenaj kapasiteleri ile projelere uygun alternatif mekanik çözümler sunan, 360 derece dönebilen yüksek drenaj kapasiteli koku fermatürlü S sifon, saç tutucu, 20 cm genişliğinde bütül bant, uygulama sonrası oluşabilecek kot farklılıklarını önleyen yükseklik ayar setini uygulama kolaylığı sağlayacak şekilde standardize ederek. Tek parça ürün olarak birleştiriyor ve kullanıcılara kolay montaj avantajı sunuyor.

EBAT Size	Inox Satinox	Inox Ayna Mirror	Altın Ayna Gold	Bakır Ayna Bronze				
40 cm	DS 040 01 09 S01	140 \$	DS 040 00 09 S01	168 \$	DS 040 20 09 S01	182 \$	DS 040 30 09 S01	200 \$
60 cm	DS 060 01 09 S01	174 \$	DS 060 00 09 S01	201 \$	DS 060 20 09 S01	219 \$	DS 060 30 09 S01	241 \$
80 cm	DS 080 01 09 S01	213 \$	DS 080 00 09 S01	232 \$	DS 080 20 09 S01	247 \$	DS 080 30 09 S01	272 \$
120 cm	DS 120 01 09 S01	293 \$	DS 120 00 09 S01	332 \$	DS 120 20 09 S01	348 \$	DS 120 30 09 S01	383 \$



Sifon Tipi : S01

EBAT Size	Inox Satinox	Inox Ayna Mirror	Altın Ayna Gold	Bakır Ayna Bronze				
40 cm	DS 040 01 09 S02	140 \$	DS 040 00 09 S02	168 \$	DS 040 20 09 S02	182 \$	DS 040 30 09 S02	200 \$
60 cm	DS 060 01 09 S02	174 \$	DS 060 00 09 S02	201 \$	DS 060 20 09 S02	219 \$	DS 060 30 09 S02	241 \$
80 cm	DS 080 01 09 S02	213 \$	DS 080 00 09 S02	232 \$	DS 080 20 09 S02	247 \$	DS 080 30 09 S02	272 \$
120 cm	DS 120 01 09 S02	293 \$	DS 120 00 09 S02	332 \$	DS 120 20 09 S02	348 \$	DS 120 30 09 S02	383 \$



Sifon Tipi : S02

S01

h : 60 mm
Debi: 51 lt/dk - Flow: 51 lt/min
Kokusuz / Odor free



S02

h : 70 mm
Debi: 48 lt/dk - Flow: 48 lt/min
Kokusuz / Odor free



S03

h : 30/80 mm
Karot ø: 120mm -Care Drill Diameter ø: 120mm
Kokusuz / Odor free



EBAT Size	Inox Satinox	Inox Ayna Mirror	Altın Ayna Gold	Bakır Ayna Bronze
40 cm	DS 040 01 09 S10 155 \$	DS 040 00 09 S10 183 \$	DS 040 20 09 S10 197 \$	DS 040 30 09 S10 217 \$
60 cm	DS 060 01 09 S10 189 \$	DS 060 00 09 S10 216 \$	DS 060 20 09 S10 234 \$	DS 060 30 09 S10 261 \$
80 cm	DS 080 01 09 S10 228 \$	DS 080 00 09 S10 247 \$	DS 080 20 09 S10 262 \$	DS 080 30 09 S10 288 \$
120 cm	DS 120 01 09 S10 308 \$	DS 120 00 09 S10 347 \$	DS 120 20 09 S10 363 \$	DS 120 30 09 S10 399 \$



Sifon Tipi : S10

EBAT Size	Inox Satinox	Inox Ayna Mirror	Altın Ayna Gold	Bakır Ayna Bronze
40 cm	DS 040 01 09 S11 155 \$	DS 040 00 09 S11 183 \$	DS 040 20 09 S11 197 \$	DS 040 30 09 S11 217 \$
60 cm	DS 060 01 09 S11 189 \$	DS 060 00 09 S11 216 \$	DS 060 20 09 S11 234 \$	DS 060 30 09 S11 261 \$
80 cm	DS 080 01 09 S11 228 \$	DS 080 00 09 S11 247 \$	DS 080 20 09 S11 262 \$	DS 080 30 09 S11 288 \$
120 cm	DS 120 01 09 S11 308 \$	DS 120 00 09 S11 347 \$	DS 120 20 09 S11 363 \$	DS 120 30 09 S11 399 \$



Sifon Tipi : S11

EBAT Size	Inox Satinox	Inox Ayna Mirror	Altın Ayna Gold	Bakır Ayna Bronze
40 cm	DS 040 01 09 S03 140 \$	DS 040 00 09 S03 168 \$	DS 040 20 09 S03 182 \$	DS 040 30 09 S03 200 \$
60 cm	DS 060 01 09 S03 174 \$	DS 060 00 09 S03 201 \$	DS 060 20 09 S03 219 \$	DS 060 30 09 S03 241 \$
80 cm	DS 080 01 09 S03 213 \$	DS 080 00 09 S03 232 \$	DS 080 20 09 S03 247 \$	DS 080 30 09 S03 272 \$
120 cm	DS 120 01 09 S03 293 \$	DS 120 00 09 S03 332 \$	DS 120 20 09 S03 348 \$	DS 120 30 09 S03 383 \$



Sifon Tipi : S03

EBAT Size	Inox Satinox	Inox Ayna Mirror	Altın Ayna Gold	Bakır Ayna Bronze
40 cm	DS 040 01 09 S08 175 \$	DS 040 00 09 S08 203 \$	DS 040 20 09 S08 217 \$	DS 040 30 09 S08 239 \$
60 cm	DS 060 01 09 S08 209 \$	DS 060 00 09 S08 236 \$	DS 060 20 09 S08 254 \$	DS 060 30 09 S08 279 \$
80 cm	DS 080 01 09 S08 248 \$	DS 080 00 09 S08 267 \$	DS 080 20 09 S08 282 \$	DS 080 30 09 S08 310 \$
120 cm	DS 120 01 09 S08 328 \$	DS 120 00 09 S08 367 \$	DS 120 20 09 S08 383 \$	DS 120 30 09 S08 421 \$



Sifon Tipi : S08

S08

h : 30/80 mm
Karot ø: 110 mm - Care Drill Diameter ø: 110 mm
Kokusuz / Odor free



S10

h : 60 mm
Debi: 60 lt/dk - Flow: 60 lt/min
Kokusuz / Odor free



S11

h : 70 mm
Debi: 60 lt/dk - Flow: 60 lt/min
Kokusuz / Odor free



INFINITY

R Dirayn

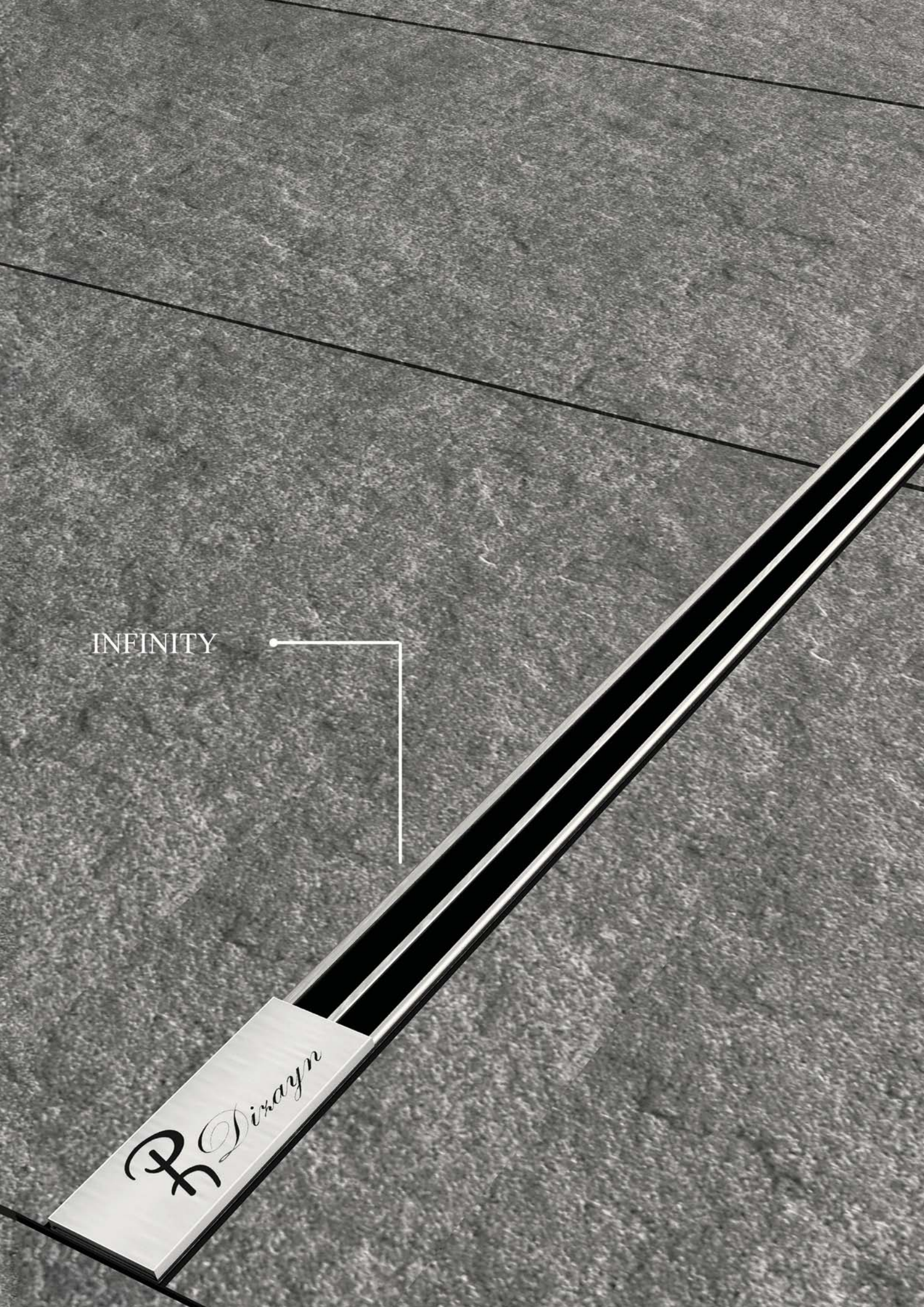

Uygulama Kesit :

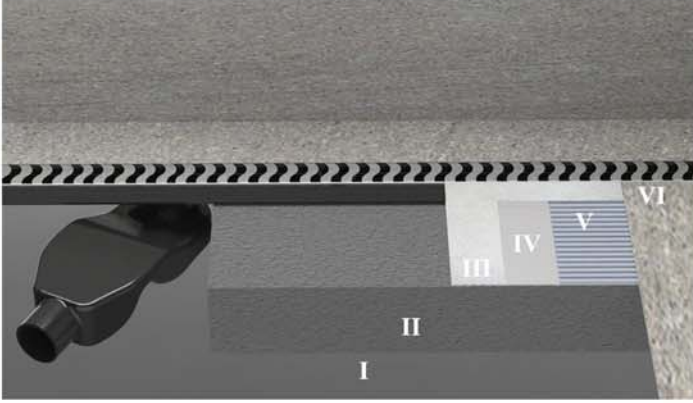

1. Döşeme Betonu / Covering Concrete
2. Tesviye Betonu / Levelling Concrete
3. Ph Dizayn Butil Bant / ph design Butil Bant
4. İzolasyon Katmanı / Insulation Layer
5. Yapıştırıcı / Adhesive
6. Kaplama Malzemesi / Covering

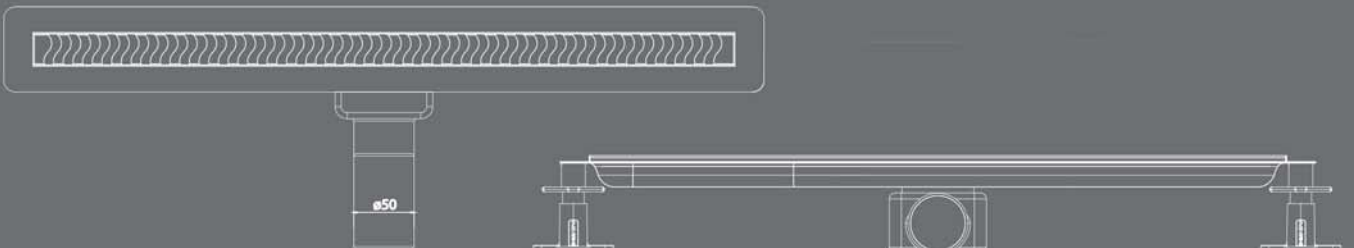
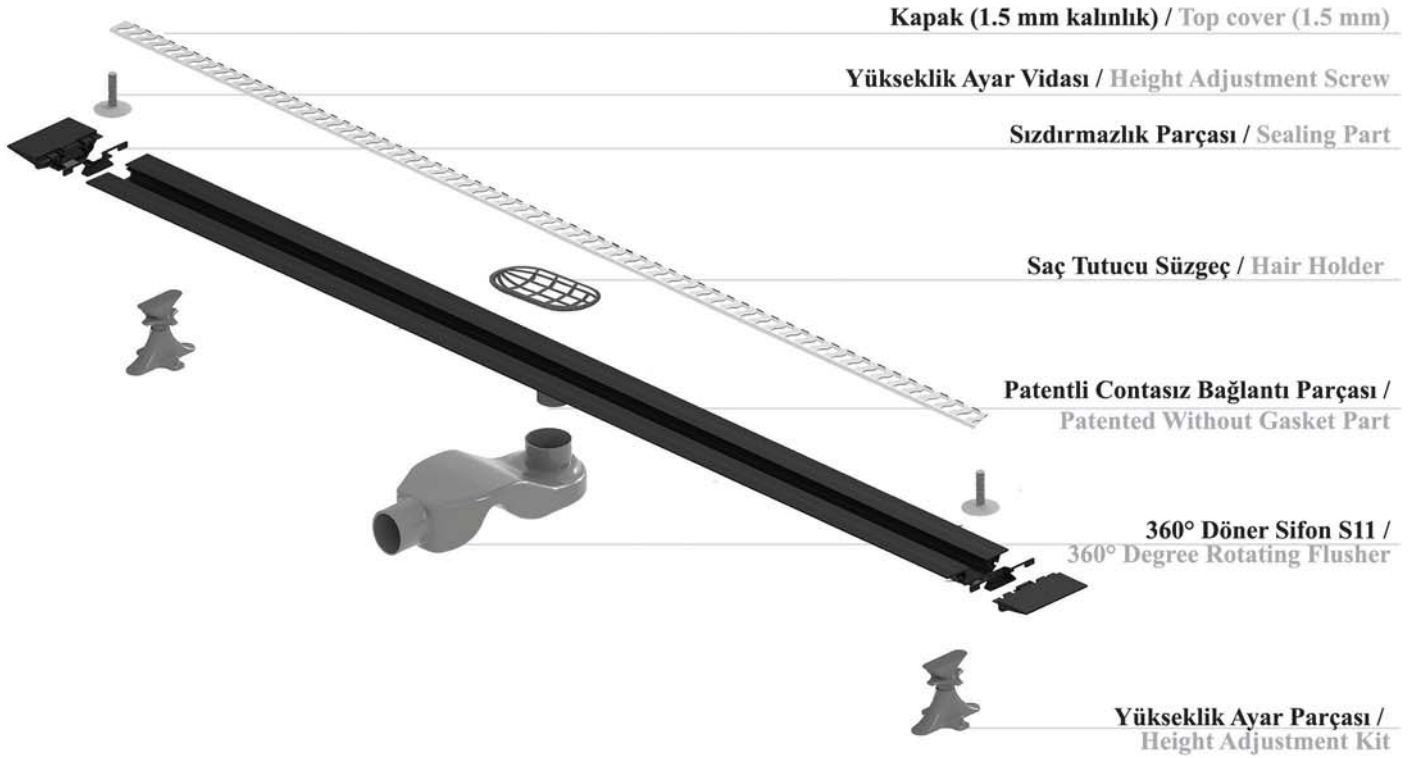

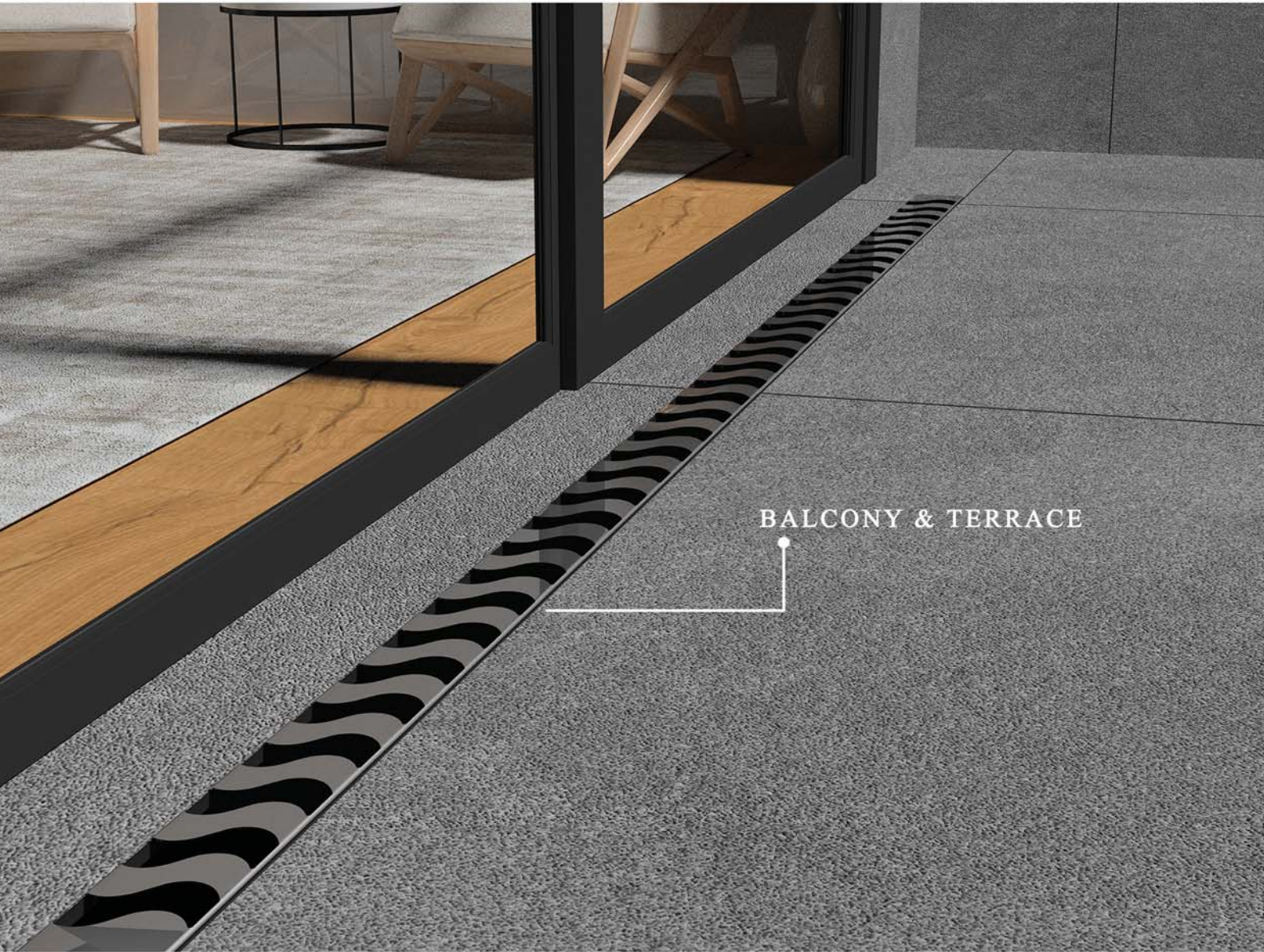

BALCONY & TERRACE

EBAT Size	Sifon / S01 Siphon	Sifon / S02 Siphon	Sifon / S03 Siphon
60	BT 060 01 19 S01 200 \$	BT 060 01 19 S02 200 \$	BT 060 01 19 S03 200 \$
100	BT 100 01 19 S01 250 \$	BT 100 01 19 S02 250 \$	BT 100 01 19 S03 250 \$
200	BT 200 01 19 S01 406 \$	BT 200 01 19 S02 406 \$	BT 200 01 19 S03 406 \$
300	BT 300 01 19 S01 515 \$	BT 300 01 19 S02 515 \$	BT 300 01 19 S03 515 \$

EBAT Size	Sifon / S08 Siphon	Sifon / S10 Siphon	Sifon / S11 Siphon
60	BT 060 01 19 S08 215 \$	BT 060 01 19 S10 235 \$	BT 060 01 19 S11 235 \$
100	BT 100 01 19 S08 265 \$	BT 100 01 19 S10 285 \$	BT 100 01 19 S11 285 \$
200	BT 200 01 19 S08 421 \$	BT 200 01 19 S10 441 \$	BT 200 01 19 S11 441 \$
300	BT 300 01 19 S08 530 \$	BT 300 01 19 S10 555 \$	BT 300 01 19 S11 555 \$

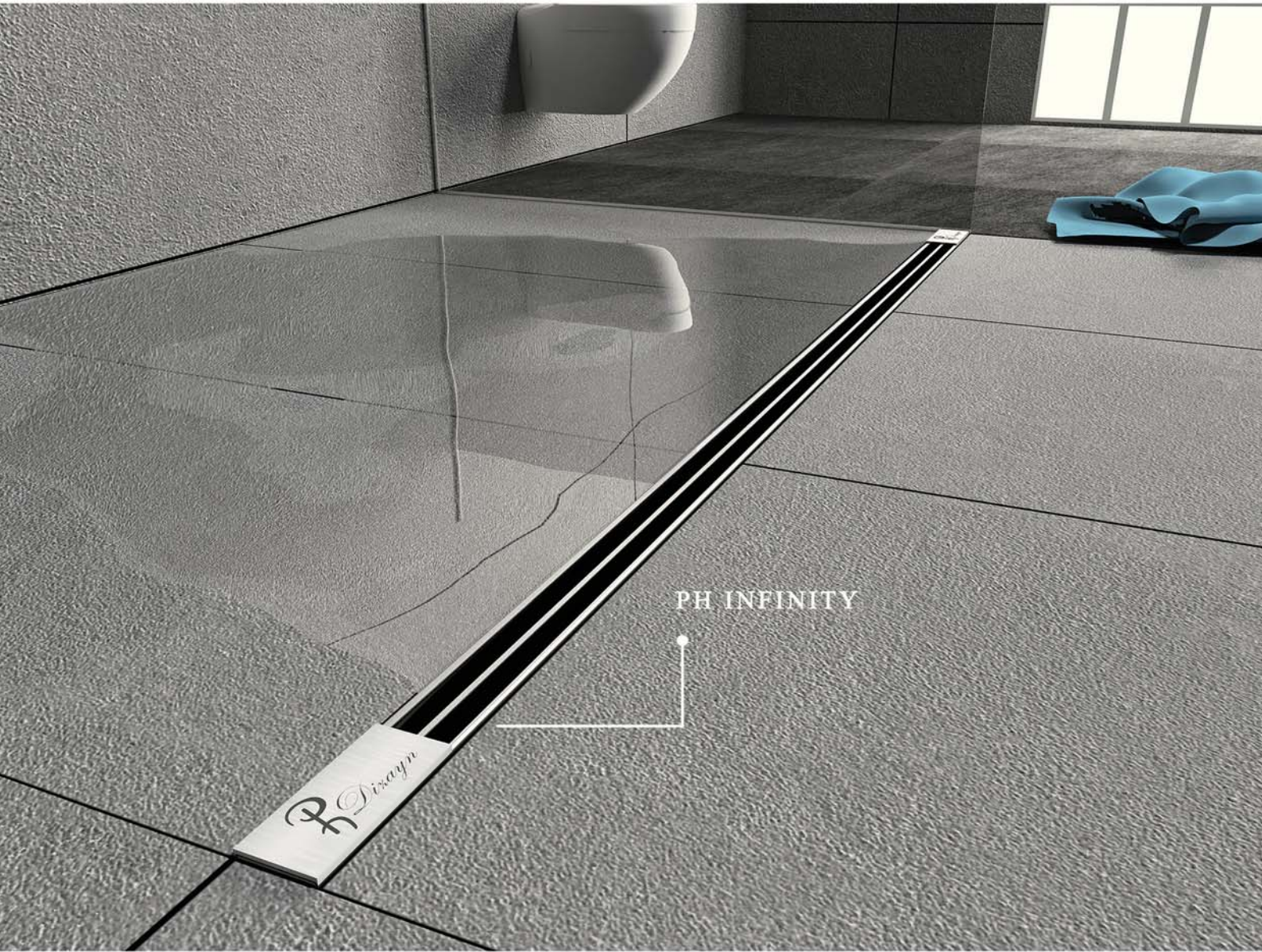

EBAT Size	Sifon / S01 Siphon		Sifon / S02 Siphon		Sifon / S03 Siphon	
60 cm	PI 060 01 20 S01	200 \$	PI 060 01 20 S02	200 \$	PI 060 01 20 S03	200 \$
100 cm	PI 100 01 20 S01	250 \$	PI 100 01 20 S02	250 \$	PI 100 01 20 S03	250 \$
200 cm	PI 200 01 20 S01	406 \$	PI 200 01 20 S02	406 \$	PI 200 01 20 S03	406 \$
300 cm	PI 300 01 20 S01	515 \$	PI 300 01 20 S02	515 \$	PI 300 01 20 S03	515 \$

EBAT Size	Sifon / S08 Siphon		Sifon / S10 Siphon		Sifon / S11 Siphon	
60 cm	PI 060 01 20 S08	215 \$	PI 060 01 20 S10	235 \$	PI 060 01 20 S11	235 \$
100 cm	PI 100 01 20 S08	265 \$	PI 100 01 20 S10	285 \$	PI 100 01 20 S11	285 \$
200 cm	PI 200 01 20 S08	421 \$	PI 200 01 20 S10	441 \$	PI 200 01 20 S11	441 \$
300 cm	PI 300 01 20 S08	530 \$	PI 300 01 20 S10	555 \$	PI 300 01 20 S11	555 \$

PH ART-FLOW

304 stainles steel		
+ easy to clean		
60 mm	51l/min	odor prevent system
360° base rotation	easy assembling	Ø50 output

Düş kanallarında PH Art Flow... Ürünün görsel zerafetiyle banyo ayrı bir keyif... PH Art Flow serisi 6 cm yüzey genişliği sunan son teknoloji üretim ile ıslak mekanlara yepyeni tasarım seçenekleri sunuyor. PH Art Flow yüzey genişliği [6] slim sifon yüksekliği [6cm]'ne sahip olan PH Art Flow aynı zamanda 3 farklı dekoratif renklerde üretilen ızgara çerçevesi ve tüm seramik yüzeyler ile mükemmel kombinasyon sağlıyor. Sahip olduğu yalıtım eteği ile drenaj için mükemmel bir çözüm sunuyor. 360 derece döner sifon ile kolay montaj sağlıyor. En önemli özelliklerinden biri de ızgara çerçevesi, yükseklik ayar seti ve süzgecin aynı parçada tasarım olarak sunulması.



R Design

Uygulama Kesit :

1. Döşeme Betonu / Covering Concrete
2. Tesviye Betonu / Levelling Concrete
3. Ph Dizayn Butil Bant / ph design Butil Bant
4. İzolasyon Katmanı / Insulation Layer
5. Yapıştırıcı / Adhesive
6. Kaplama Malzemesi / Covering

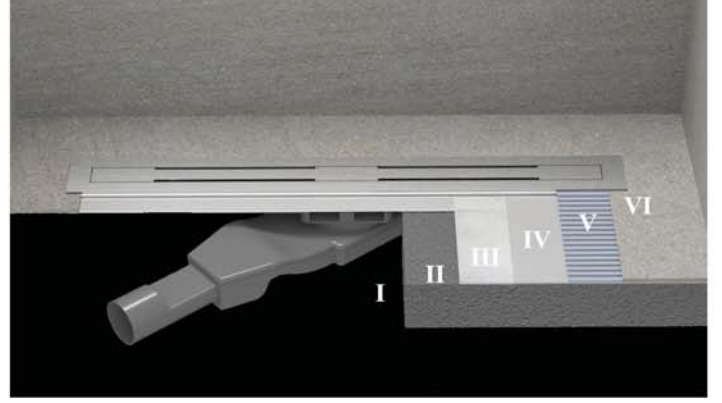

Sifon Tipi : S01

Kapak (1.5 mm kalınlık) / Top cover (1.5 mm)

Yükseklik Ayar Çerçevesi (2.5mm)/ Final height adjustment Frame (2.5mm)

Yükseklik Ayar Vidası / Height Adjustment Screw

Saç Tutucu Süzgeç / Hair Holder

Yalıtım Etekli Ana Gövde / Insulated Main Body

Patentli Contasız Bağlantı Parçası / Patented Without Gasket Part

360° Döner Sifon S01 / 360° Degree Rotating Flusher

Yükseklik Ayar Parçası / Height Adjustment Kit

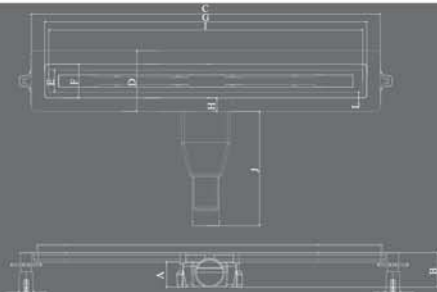

	40	50	60	80	120
A	4.3	4.3	4.3	4.3	4.3
B	6	6	6	6	6
C	45	55	65	85	125
D	11.3	11.3	11.3	11.3	11.3
E	4.1	4.1	4.1	4.1	4.1
F	6.3	6.3	6.3	6.3	6.3
G	40	50	60	80	120
H	2.5	2.5	2.5	2.5	2.5
I	38.4	58.4	58.4	78.4	118.4
J	21.3	21.3	21.3	21.3	21.3
K	0.8	0.8	0.8	0.8	0.8
L	1.1	1.1	1.1	1.1	1.1

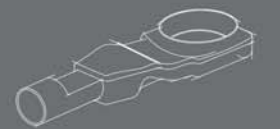

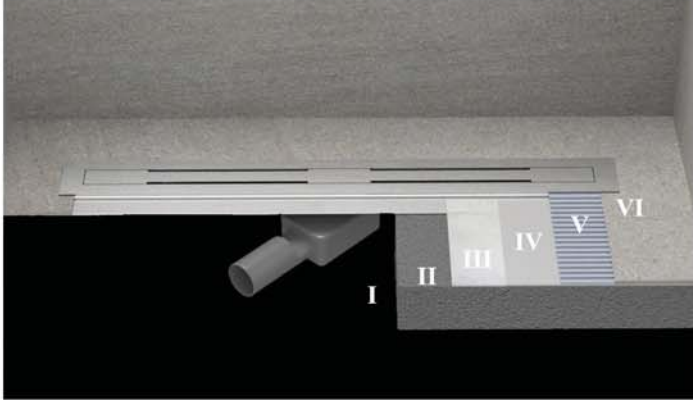

Uygulama Kesit :

1. Döşeme Betonu / Covering Concrete
2. Tesviye Betonu / Levelling Concrete
3. Ph Dizayn Butil Bant / ph design Butil Bant
4. İzolasyon Katmanı / Insulation Layer
5. Yapıştırıcı / Adhesive
6. Kaplama Malzemesi / Covering

Sifon Tipi : S02

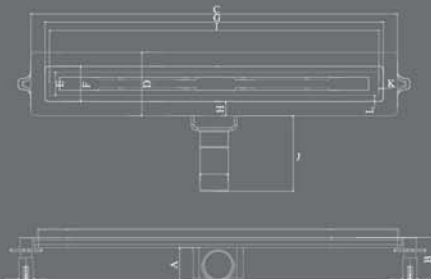
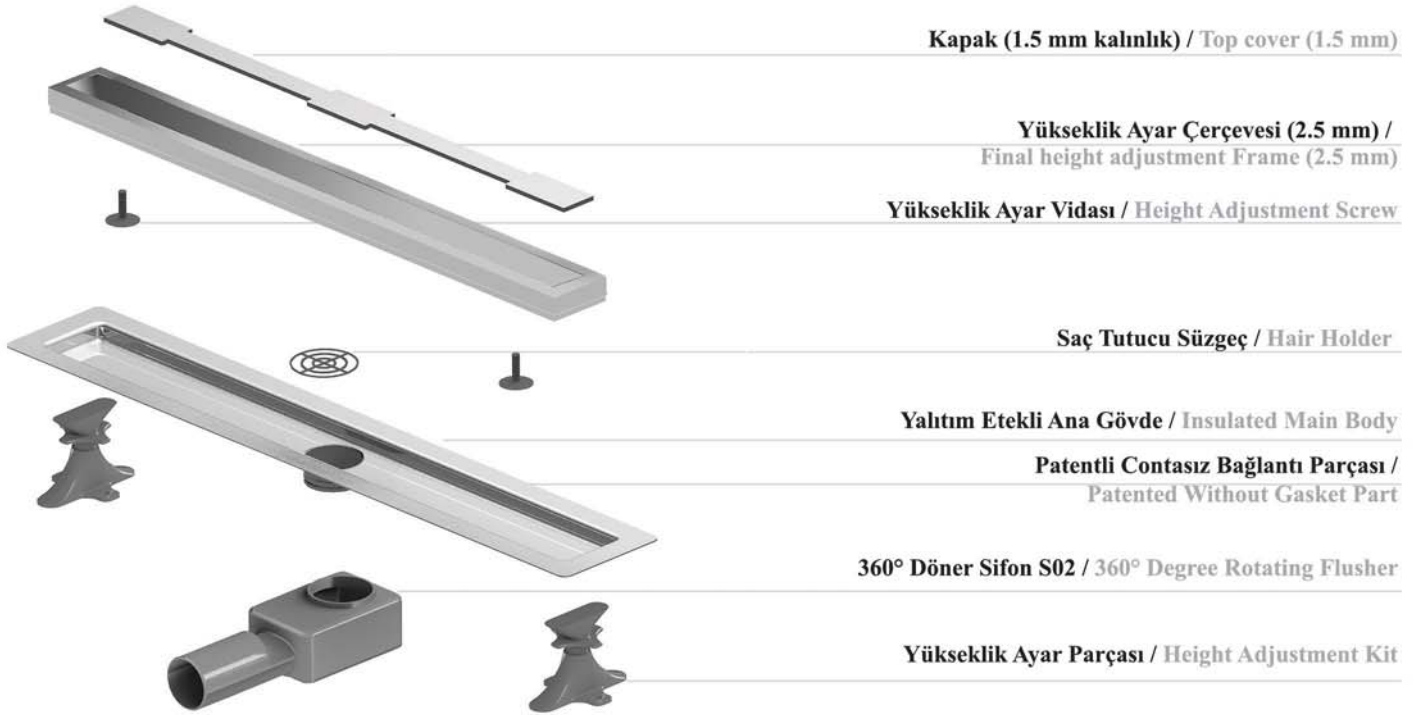

	40	50	60	80	120
A	5	5	5	5	5
B	7	7	7	7	7
C	45	55	65	85	125
D	11.3	11.3	11.3	11.3	11.3
E	4.1	4.1	4.1	4.1	4.1
F	6.3	6.3	6.3	6.3	6.3
G	40	50	60	80	120
H	2.5	2.5	2.5	2.5	2.5
I	38.4	48.4	58.4	78.4	118.4
J	13.5	13.5	13.5	13.5	13.5
K	0.8	0.8	0.8	0.8	0.8
L	1.1	1.1	1.1	1.1	1.1

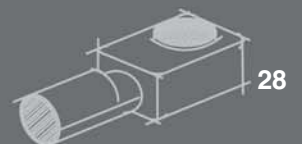

Uygulama Kesit :

1. Döşeme Betonu / Covering Concrete
2. Tesviye Betonu / Levelling Concrete
3. Ph Dizayn Butil Bant / ph design Butil Bant
4. İzolasyon Katmanı / Insulation Layer
5. Yapıştırıcı / Adhesive
6. Kaplama Malzemesi / Covering

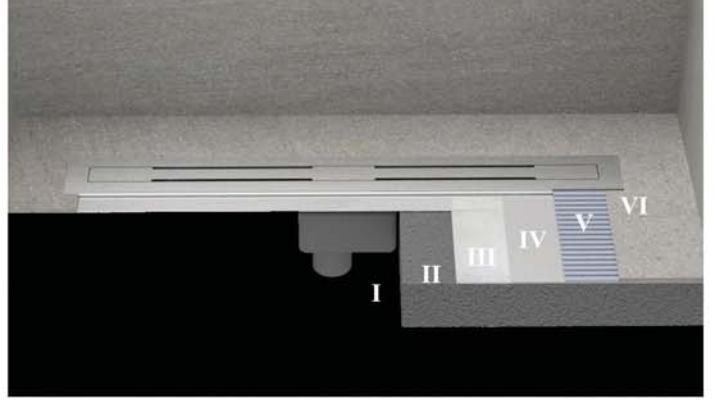

Sifon Tipi : S01

Kapak (1.5 mm kalınlık) / Top cover (1.5 mm)

Yükseklik Ayar Çerçevesi (2.5 mm) / Final height adjustment Frame (2.5 mm)

Yükseklik Ayar Vidası / Height Adjustment Screw

Saç Tutucu Süzgeç / Hair Holder

Yalıtım Etekli Ana Gövde / Insulated Main Body

Patentli Contasız Bağlantı Parçası / Patented Without Gasket Part

360° Döner Sifon S03 / 360° Degree Rotating Flusher

Yükseklik Ayar Parçası / Height Adjustment Kit

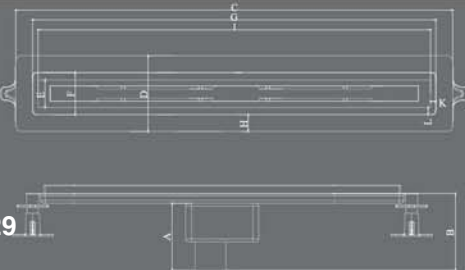
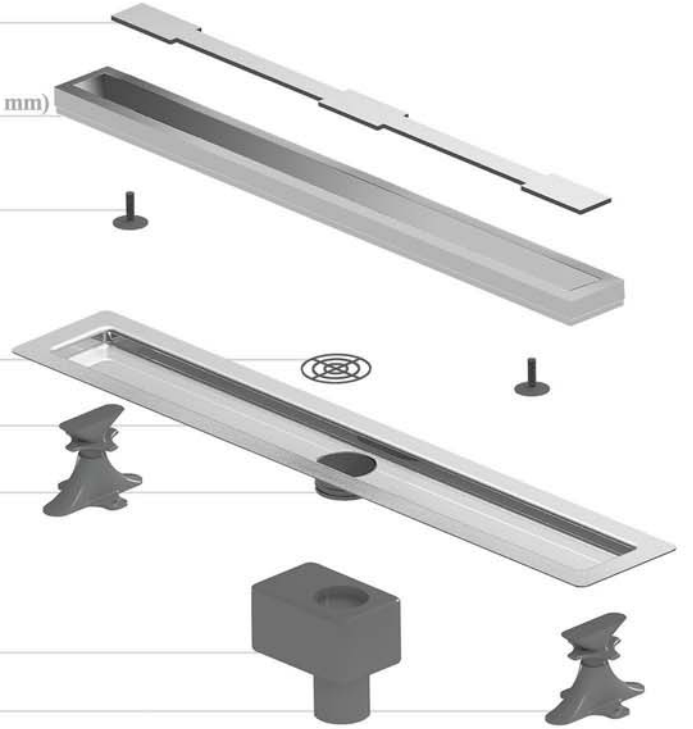

	40	50	60	80	120
A	11	11	11	11	11
B	12.6	12.6	12.6	12.6	12.6
C	45	55	65	85	125
D	11.3	11.3	11.3	11.3	11.3
E	4.1	4.1	4.1	4.1	4.1
F	6.3	6.3	6.3	6.3	6.3
G	40	50	60	80	120
H	2.5	2.5	2.5	2.5	2.5
I	38.4	38.4	58.4	78.4	118.4
K	0.8	0.8	0.8	0.8	0.8
L	1.1	1.1	1.1	1.1	1.1



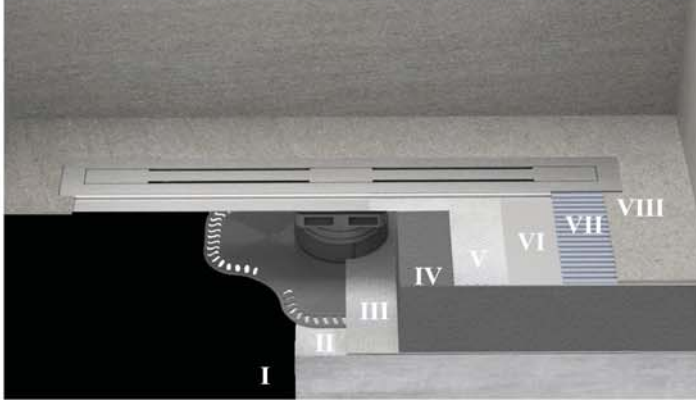

Uygulama Kesit :

1. Beton Katmanı / Concrete Layer
2. İzolasyon Katmanı / Insulation Layer
3. Döşeme Betonu / Covering Concrete
4. Tesviye Betonu / Levelling Concrete
5. Ph Dizayn Butil Bant / ph design Butyl Bant
6. İzolasyon Katmanı / Insulation Layer
7. Yapıştırıcı / Adhesive
8. Kaplama Malzemesi / Covering

Sifon Tipi : S08

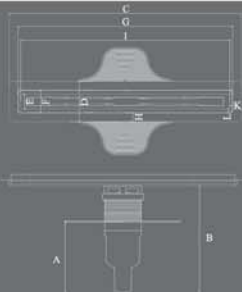
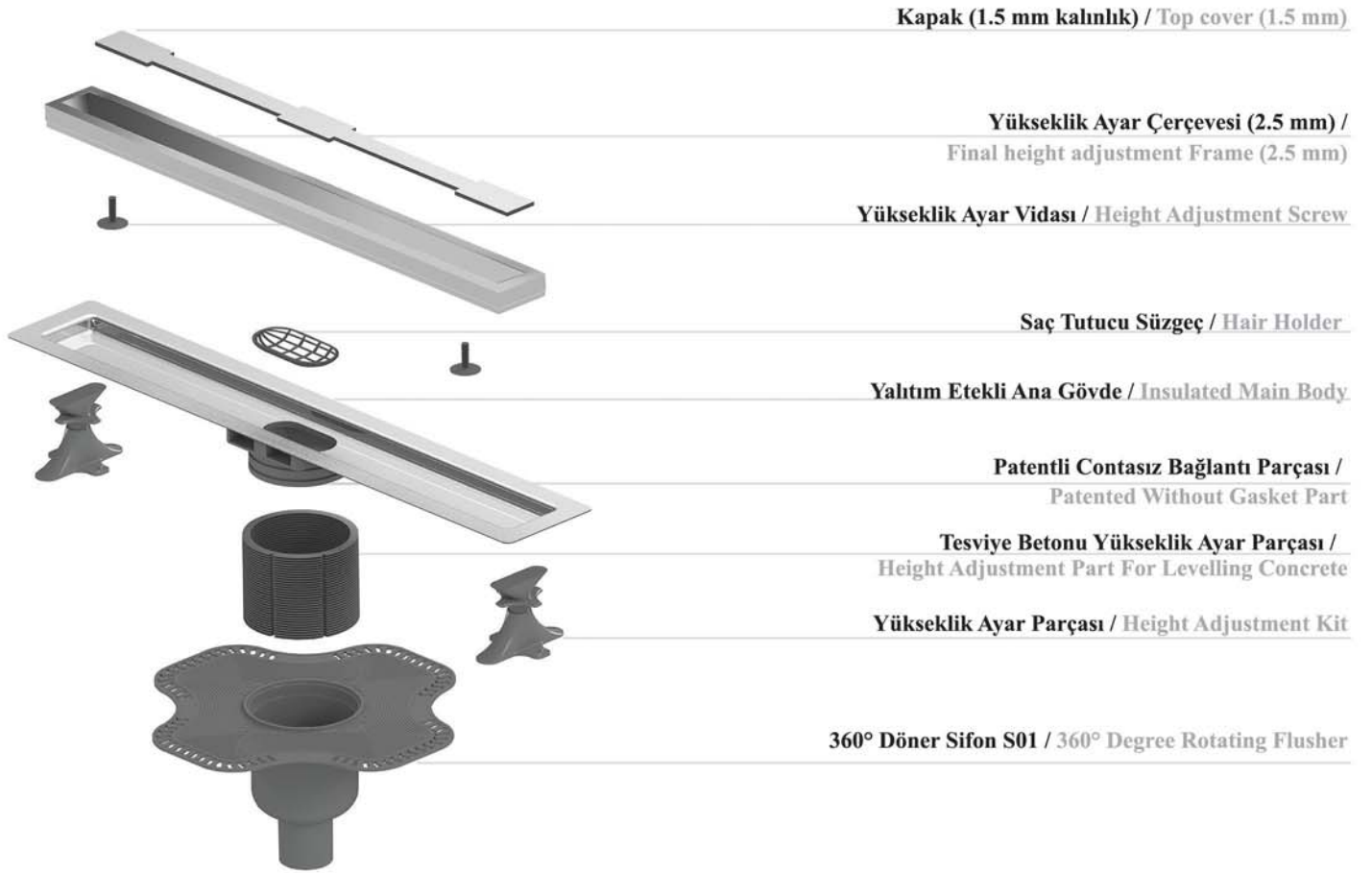

	40	50	60	80	120
A	16	16	16	16	16
B	AYARLANABİLİR	AYARLANABİLİR	AYARLANABİLİR	AYARLANABİLİR	AYARLANABİLİR
C	45	55	65	85	125
D	11.3	11.3	11.3	11.3	11.3
E	4.1	4.1	4.1	4.1	4.1
F	6.3	6.3	6.3	6.3	6.3
G	40	50	60	80	120
H	2.5	2.5	2.5	2.5	2.5
I	38.4	48.4	58.4	78.4	118.4
J	9.4	9.4	9.4	9.4	9.4
K	0.8	0.8	0.8	0.8	0.8
L	1.1	1.1	1.1	1.1	1.1

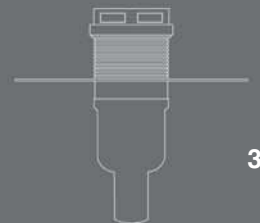

Uygulama Kesit :

1. Döşeme Betonunu / Covering Concrete
2. Tesviye Betonunu / Levelling Concrete
3. Ph Dizayn Butil Bant / ph design Butil Bant
4. İzolasyon Katmanı / Insulation Layer
5. Yapıştırıcı / Adhesive
6. Kaplama Malzemesi / Covering

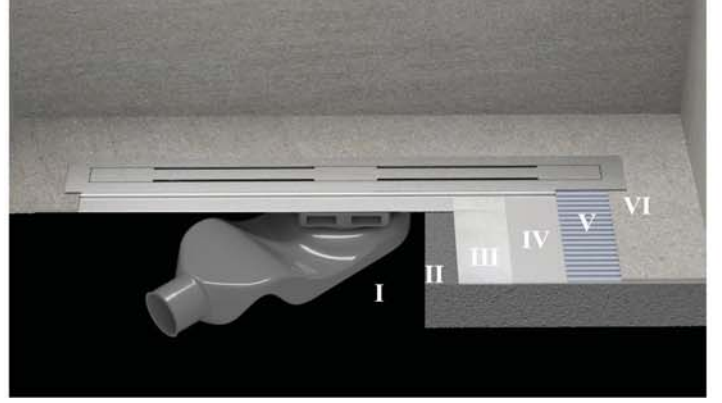

Sifon Tipi : S10

Kapak (1.5 mm kalınlık) / Top cover (1.5 mm)

Yükseklik Ayar Çerçevesi (2.5 mm) / Final height adjustment Frame (2.5 mm)

Yükseklik Ayar Vidası / Height Adjustment Screw

Saç Tutucu Süzgeç / Hair Holder

Yalıtım Etekli Ana Gövde / Insulated Main Body

Patentli Contasız Bağlantı Parçası / Patented Without Gasket Part

360° Döner Sifon S10 / 360° Degree Rotating Flusher

Yükseklik Ayar Parçası / Height Adjustment Kit

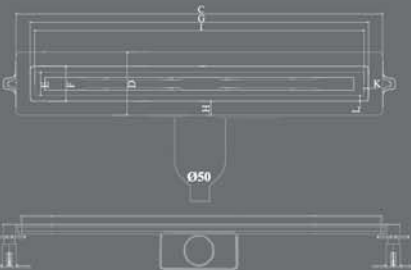
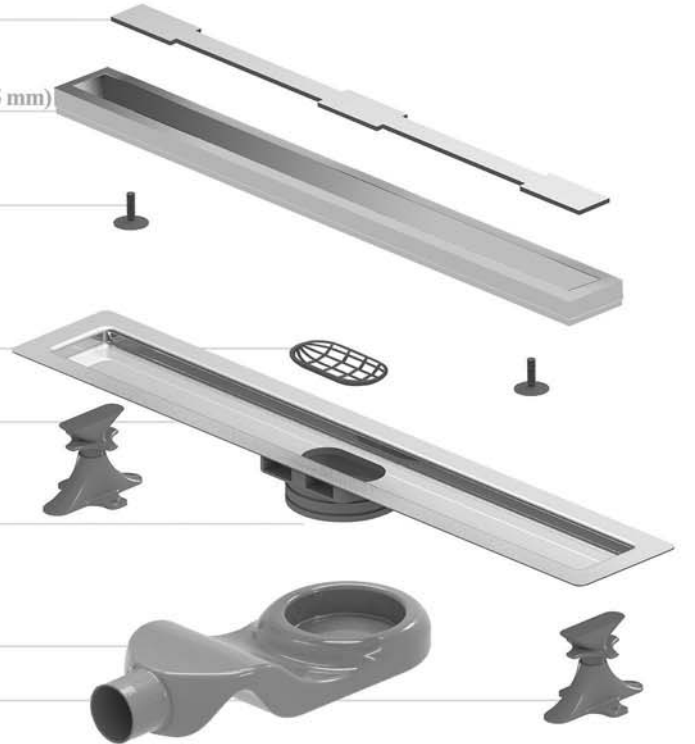

	40	50	60	80	120
A	4.3	4.3	4.3	4.3	4.3
B	6	6	6	6	6
C	45	55	65	85	125
D	11.3	11.3	11.3	11.3	11.3
E	4.1	4.1	4.1	4.1	4.1
F	6.3	6.3	6.3	6.3	6.3
G	40	50	60	80	120
H	2.5	2.5	2.5	2.5	2.5
I	38.4	58.4	58.4	78.4	118.4
J	21.3	21.3	21.3	21.3	21.3
K	0.8	0.8	0.8	0.8	0.8
L	1.1	1.1	1.1	1.1	1.1



Uygulama Kesit :

1. Döşeme Betonu / Covering Concrete
2. Tesviye Betonu / Levelling Concrete
3. Ph Dizayn Butil Bant / ph design Butil Bant
4. İzolasyon Katmanı / Insulation Layer
5. Yapıştırıcı / Adhesive
6. Kaplama Malzemesi / Covering

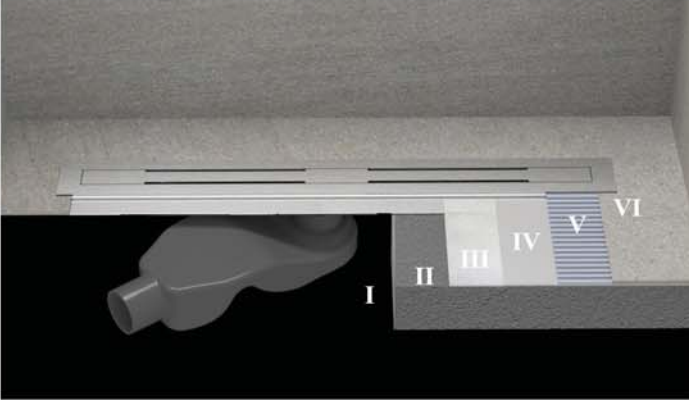

Sifon Tipi : S11

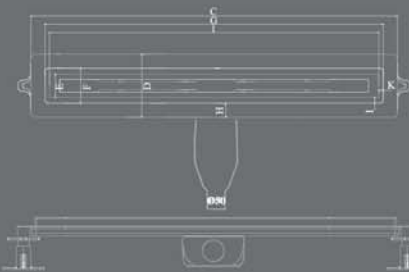
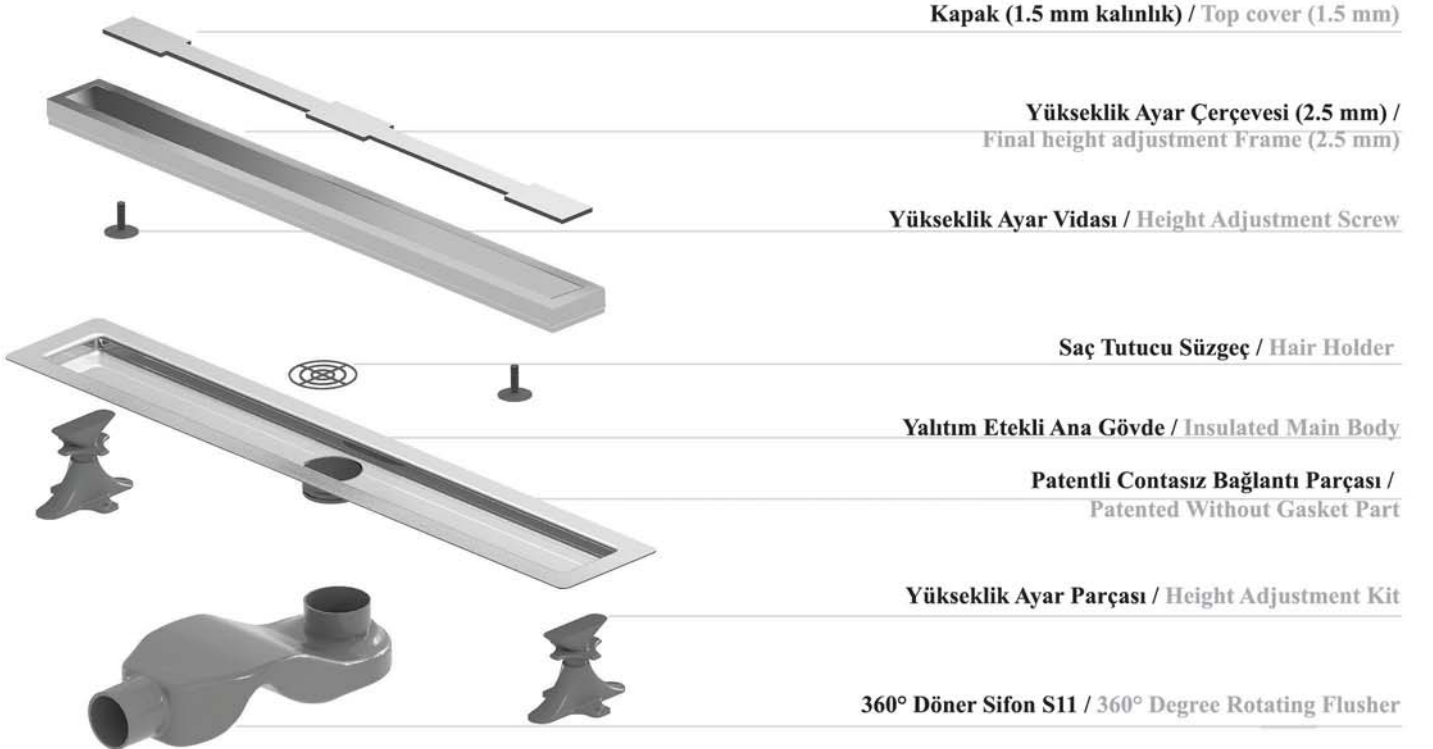

	40	50	60	80	120
A	5	5	5	5	5
B	7	7	7	7	7
C	45	55	65	85	125
D	11.3	11.3	11.3	11.3	11.3
E	4.1	4.1	4.1	4.1	4.1
F	6.3	6.3	6.3	6.3	6.3
G	40	50	60	80	120
H	2.5	2.5	2.5	2.5	2.5
I	38.4	48.4	58.4	78.4	118.4
J	13.5	13.5	13.5	13.5	13.5
K	0.8	0.8	0.8	0.8	0.8
L	1.1	1.1	1.1	1.1	1.1





PH DESIGN

Slim serisi ile duş alanlarına modern , estetik ve kullanışlı çözümler sunuyor. Hemzemin uygulama karo ile bütünleşerek engelsiz banyolar yaratıyor. Yeni teknolojiyi kullanarak PATENTLİ CONTASIZ sistem ile sızdırmalıkta standartları yeniden belirleniyor. **Slim serisi ürünler;**
-Yalıtım bitimli kaynaksız yekpare gövde, şap yüksekliğini için yükseklik ayar seti, farklı montaj yükseklikleri ve drenaj kapasiteleri ile projelere uygun alternatif mekanik çözümler sunan, 360 derece dönebilen yüksek drenaj kapasiteli koku fermatürlü S sifon, saç tutucu, 20 cm genişliğinde bütül bant, uygulama sonrası oluşabilecek kot farklılıklarını önleyen yükseklik ayar setini uygulama kolaylığı sağlayacak şekilde standardize ederek. Tek parça ürün olarak birleştiriyor ve kullanıcılara kolay montaj avantajı sunuyor.

EBAT Size	Inox Satinox	Inox Ayna Mirror	Altın Ayna Gold	Bakır Ayna Bronze
40 cm	DF 040 01 07 S01	DF 040 00 07 S01	DF 040 20 07 S01	DF 040 30 07 S01
50 cm	DF 050 01 07 S01	DF 050 00 07 S01	DF 050 20 07 S01	DF 050 30 07 S01
60 cm	DF 060 01 07 S01	DF 060 00 07 S01	DF 060 20 07 S01	DF 060 30 07 S01
80 cm	DF 080 01 07 S01	DF 080 00 07 S01	DF 080 20 07 S01	DF 080 30 07 S01
120 cm	DF 120 01 07 S01	DF 120 00 07 S01	DF 120 20 07 S01	DF 120 30 07 S01



Sifon Tipi : S01

EBAT Size	Inox Satinox	Inox Ayna Mirror	Altın Ayna Gold	Bakır Ayna Bronze
40 cm	DF 040 01 07 S02	DF 040 00 07 S02	DF 040 20 07 S02	DF 040 30 07 S02
50 cm	DF 050 01 07 S02	DF 050 00 07 S02	DF 040 10 07 S02	DF 050 30 07 S02
60 cm	DF 060 01 07 S02	DF 060 00 07 S02	DF 060 20 07 S02	DF 060 30 07 S02
80 cm	DF 080 01 07 S02	DF 080 00 07 S02	DF 080 20 07 S02	DF 080 30 07 S02
120 cm	DF 120 01 07 S02	DF 120 00 07 S02	DF 120 20 07 S02	DF 120 30 07 S02



Sifon Tipi : S02

S01

h : 60 mm
Debi: 51 lt/dk - Flow: 51 lt/min
Kokusuz / Odor free



S02

h : 70 mm
Debi: 48 lt/dk - Flow: 48 lt/min
Kokusuz / Odor free



S03

h : 30/80 mm
Karat ø: 120mm -Care Drill Diameter ø: 120mm
Kokusuz / Odor free



EBAT Size	Inox Satinox		Inox Ayna Mirror		Altın Ayna Gold		Bakır Ayna Bronze	
40 cm	DF 040 01 07 S10	169 \$	DF 040 00 07 S10	200 \$	DF 040 20 07 S10	215 \$	DF 040 30 07 S10	236 \$
50 cm	DF 050 01 07 S10	187 \$	DF 050 00 07 S10	214 \$	DF 050 20 07 S10	232 \$	DF 050 30 07 S10	255 \$
60 cm	DF 060 01 07 S10	206 \$	DF 060 00 07 S10	236 \$	DF 060 20 07 S10	255 \$	DF 060 30 07 S10	280 \$
80 cm	DF 080 01 07 S10	249 \$	DF 080 00 07 S10	271 \$	DF 080 20 07 S10	287 \$	DF 080 30 07 S10	316 \$
120 cm	DF 120 01 07 S10	338 \$	DF 120 00 07 S10	381 \$	DF 120 20 07 S10	398 \$	DF 120 30 07 S10	438 \$



Sifon Tipi : S10

EBAT Size	Inox Satinox		Inox Ayna Mirror		Altın Ayna Gold		Bakır Ayna Bronze	
40 cm	DF 040 01 07 S11	169 \$	DF 040 00 07 S11	200 \$	DF 040 20 07 S11	215 \$	DF 040 30 07 S11	236 \$
50 cm	DF 050 01 07 S11	187 \$	DF 050 00 07 S11	214 \$	DF 050 20 07 S11	232 \$	DF 050 30 07 S11	255 \$
60 cm	DF 060 01 07 S11	206 \$	DF 060 00 07 S11	236 \$	DF 060 20 07 S11	255 \$	DF 060 30 07 S11	280 \$
80 cm	DF 080 01 07 S11	249 \$	DF 080 00 07 S11	271 \$	DF 080 20 07 S11	287 \$	DF 080 30 07 S11	316 \$
120 cm	DF 120 01 07 S11	338 \$	DF 120 00 07 S11	381 \$	DF 120 20 07 S11	398 \$	DF 120 30 07 S11	438 \$



Sifon Tipi : S11

EBAT Size	Inox Satinox		Inox Ayna Mirror		Altın Ayna Gold		Bakır Ayna Bronze	
40 cm	DF 040 01 07 S03	154 \$	DF 040 00 07 S03	185 \$	DF 040 20 07 S03	200 \$	DF 040 30 07 S03	220 \$
50 cm	DF 050 01 07 S03	172 \$	DF 050 00 07 S03	199 \$	DF 050 20 07 S03	217 \$	DF 050 30 07 S03	239 \$
60 cm	DF 060 01 07 S03	191 \$	DF 060 00 07 S03	221 \$	DF 060 20 07 S03	240 \$	DF 060 30 07 S03	264 \$
80 cm	DF 080 01 07 S03	234 \$	DF 080 00 07 S03	256 \$	DF 080 20 07 S03	272 \$	DF 080 30 07 S03	299 \$
120 cm	DF 120 01 07 S03	323 \$	DF 120 00 07 S03	366 \$	DF 120 20 07 S03	383 \$	DF 120 30 07 S03	421 \$



Sifon Tipi : S03

EBAT Size	Inox Satinox		Inox Ayna Mirror		Altın Ayna Gold		Bakır Ayna Bronze	
40 cm	DF 040 01 07 S08	189 \$	DF 040 00 07 S08	220 \$	DF 040 20 07 S08	235 \$	DF 040 30 07 S08	258 \$
50 cm	DF 050 01 07 S08	207 \$	DF 050 00 07 S08	234 \$	DF 050 20 07 S08	252 \$	DF 050 30 07 S08	277 \$
60 cm	DF 060 01 07 S08	226 \$	DF 060 00 07 S08	256 \$	DF 060 20 07 S08	275 \$	DF 060 30 07 S08	302 \$
80 cm	DF 080 01 07 S08	269 \$	DF 080 00 07 S08	291 \$	DF 080 20 07 S08	307 \$	DF 080 30 07 S08	338 \$
120 cm	DF 120 01 07 S08	358 \$	DF 120 00 07 S08	401 \$	DF 120 20 07 S08	418 \$	DF 120 30 07 S08	460 \$



Sifon Tipi : S08

S08

h : 30/80 mm
Karot ø: 110 mm - Care Drill Diameter ø: 110 mm
Kokusuz / Odor free



S10

h : 60 mm
Debi: 60 lt/dk - Flow: 60 lt/min
Kokusuz / Odor free



S11

h : 70 mm
Debi: 60 lt/dk - Flow: 60 lt/min
Kokusuz / Odor free





PH DESIGN

Slim serisi ile duş alanlarına modern , estetik ve kullanışlı çözümler sunuyor. Hemzemin uygulama karo ile bütünleşerek engelsiz banyolar yaratıyor. Yeni teknolojiyi kullanarak PATENTLİ CONTASIZ sistem ile sızdırmalıkta standartları yeniden belirleniyor. **Slim serisi ürünler;**
-Yalıtım bitimli kaynaksız yekpare gövde, şap yüksekliğini için yükseklik ayar seti, farklı montaj yükseklikleri ve drenaj kapasiteleri ile projelere uygun alternatif mekanik çözümler sunan, 360 derece dönebilen yüksek drenaj kapasiteli koku fermatürlü S sifon, saç tutucu, 20 cm genişliğinde bütül bant, uygulama sonrası oluşabilecek kot farklılıklarını önleyen yükseklik ayar setini uygulama kolaylığı sağlayacak şekilde standardize ederek. Tek parça ürün olarak birleştiriyor ve kullanıcılara kolay montaj avantajı sunuyor.

EBAT Size	Inox Satinox	Inox Ayna Mirror	Altın Ayna Gold	Bakır Ayna Bronze				
40 cm	DF 040 01 08 S01	154 \$	DF 040 00 08 S01	185 \$	DF 040 20 08 S01	200 \$	DF 040 30 08 S01	220 \$
50 cm	DF 050 01 08 S01	172 \$	DF 050 00 08 S01	199 \$	DF 050 20 08 S01	217 \$	DF 050 30 08 S01	239 \$
60 cm	DF 060 01 08 S01	191 \$	DF 060 00 08 S01	221 \$	DF 060 20 08 S01	240 \$	DF 060 30 08 S01	265 \$
80 cm	DF 080 01 08 S01	234 \$	DF 080 00 08 S01	256 \$	DF 080 20 08 S01	272 \$	DF 080 30 08 S01	299 \$
120 cm	DF 120 01 08 S01	323 \$	DF 120 00 08 S01	366 \$	DF 120 20 08 S01	383 \$	DF 120 30 08 S01	421 \$



Sifon Tipi : S01

EBAT Size	Inox Satinox	Inox Ayna Mirror	Altın Ayna Gold	Bakır Ayna Bronze				
40 cm	DF 040 01 08 S02	154 \$	DF 040 00 08 S02	185 \$	DF 040 20 08 S02	200 \$	DF 040 30 08 S02	220 \$
50 cm	DF 050 01 08 S02	172 \$	DF 050 00 08 S02	199 \$	DF 050 20 08 S02	217 \$	DF 050 30 08 S02	239 \$
60 cm	DF 060 01 08 S02	191 \$	DF 060 00 08 S02	221 \$	DF 060 20 08 S02	240 \$	DF 060 30 08 S02	265 \$
80 cm	DF 080 01 08 S02	234 \$	DF 080 00 08 S02	256 \$	DF 080 20 08 S02	272 \$	DF 080 30 08 S02	299 \$
120 cm	DF 120 01 08 S02	323 \$	DF 120 00 08 S02	366 \$	DF 120 20 08 S02	383 \$	DF 120 30 08 S02	421 \$



Sifon Tipi : S02

S01

h : 60 mm
Debi: 51 lt/dk - Flow: 51 lt/min
Kokusuz / Odor free



S02

h : 70 mm
Debi: 48 lt/dk - Flow: 48 lt/min
Kokusuz / Odor free

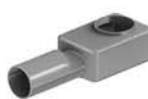

S03

h : 30/80 mm
Karot ø: 120mm -Care Drill Diameter ø: 120mm
Kokusuz / Odor free



EBAT Size	Inox Satinox		Inox Ayna Mirror		Altın Ayna Gold		Bakır Ayna Bronze	
40 cm	DF 040 01 08 S10	169 \$	DF 040 00 08 S10	200 \$	DF 040 20 08 S10	215 \$	DF 040 30 08 S10	236 \$
50 cm	DF 050 01 08 S10	187 \$	DF 050 00 08 S10	214 \$	DF 050 20 08 S10	232 \$	DF 050 30 08 S10	255 \$
60 cm	DF 060 01 08 S10	206 \$	DF 060 00 08 S10	236 \$	DF 060 20 08 S10	255 \$	DF 060 30 08 S10	280 \$
80 cm	DF 080 01 08 S10	249 \$	DF 080 00 08 S10	271 \$	DF 080 20 08 S10	287 \$	DF 080 30 08 S10	316 \$
120 cm	DF 120 01 08 S10	338 \$	DF 120 00 08 S10	381 \$	DF 120 20 08 S10	398 \$	DF 120 30 08 S10	438 \$



Sifon Tipi : S10

EBAT Size	Inox Satinox		Inox Ayna Mirror		Altın Ayna Gold		Bakır Ayna Bronze	
40 cm	DF 040 01 08 S11	169 \$	DF 040 00 08 S11	200 \$	DF 040 20 08 S11	215 \$	DF 040 30 08 S11	236 \$
50 cm	DF 050 01 08 S11	187 \$	DF 050 00 08 S11	214 \$	DF 050 20 08 S11	232 \$	DF 050 30 08 S11	255 \$
60 cm	DF 060 01 08 S11	206 \$	DF 060 00 08 S11	236 \$	DF 060 20 08 S11	255 \$	DF 060 30 08 S11	280 \$
80 cm	DF 080 01 08 S11	249 \$	DF 080 00 08 S11	271 \$	DF 080 20 08 S11	287 \$	DF 080 30 08 S11	316 \$
120 cm	DF 120 01 08 S11	338 \$	DF 120 00 08 S11	381 \$	DF 120 20 08 S11	398 \$	DF 120 30 08 S11	438 \$



Sifon Tipi : S11

EBAT Size	Inox Satinox		Inox Ayna Mirror		Altın Ayna Gold		Bakır Ayna Bronze	
40 cm	DF 040 01 08 S03	154 \$	DF 040 00 08 S03	185 \$	DF 040 20 08 S03	200 \$	DF 040 30 08 S03	220 \$
50 cm	DF 050 01 08 S03	172 \$	DF 050 00 08 S03	199 \$	DF 050 20 08 S03	217 \$	DF 050 30 08 S03	239 \$
60 cm	DF 060 01 08 S03	191 \$	DF 060 00 08 S03	221 \$	DF 060 20 08 S03	240 \$	DF 060 30 08 S03	264 \$
80 cm	DF 080 01 08 S03	234 \$	DF 080 00 08 S03	256 \$	DF 080 20 08 S03	272 \$	DF 080 30 08 S03	299 \$
120 cm	DF 120 01 08 S03	323 \$	DF 120 00 08 S03	366 \$	DF 120 20 08 S03	383 \$	DF 120 30 08 S03	421 \$



Sifon Tipi : S03

EBAT Size	Inox Satinox		Inox Ayna Mirror		Altın Ayna Gold		Bakır Ayna Bronze	
40 cm	DF 040 01 08 S08	189 \$	DF 040 00 08 S08	220 \$	DF 040 20 08 S08	235 \$	DF 040 30 08 S08	258 \$
50 cm	DF 050 01 08 S08	207 \$	DF 050 00 08 S08	234 \$	DF 050 20 08 S08	252 \$	DF 050 30 08 S08	277 \$
60 cm	DF 060 01 08 S08	226 \$	DF 060 00 08 S08	256 \$	DF 060 20 08 S08	275 \$	DF 060 30 08 S08	302 \$
80 cm	DF 080 01 08 S08	269 \$	DF 080 00 08 S08	291 \$	DF 080 20 08 S08	307 \$	DF 080 30 08 S08	338 \$
120 cm	DF 120 01 08 S08	358 \$	DF 120 00 08 S08	401 \$	DF 120 20 08 S08	418 \$	DF 120 30 08 S08	460 \$



Sifon Tipi : S08

S08

h : 30/80 mm
Karat : 110 mm - Care Drill Diameter : 110 mm
Kokusuz / Odor free



S10

h : 60 mm
Debi: 60 lt/dk - Flow: 60 lt/min
Kokusuz / Odor free



S11

h : 70 mm
Debi: 60 lt/dk - Flow: 60 lt/min
Kokusuz / Odor free



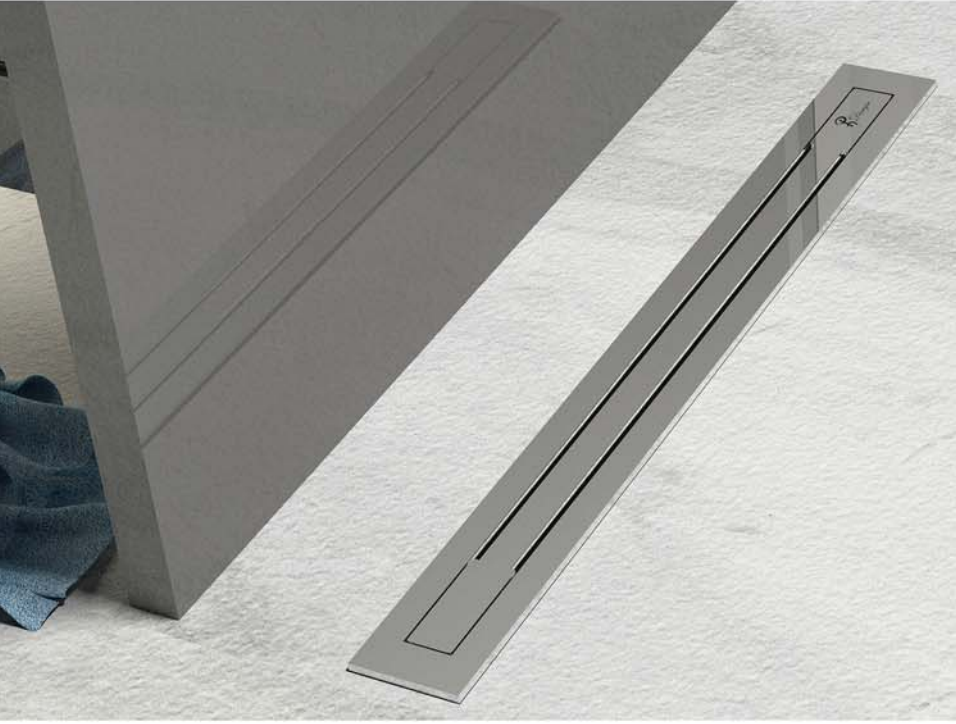

PH DESIGN

Slim serisi ile duş alanlarına modern , estetik ve kullanışlı çözümler sunuyor. Hemzemin uygulama karo ile bütünleşerek engelsiz banyolar yaratıyor. Yeni teknolojiyi kullanarak PATENTLİ CONTASIZ sistem ile sızdırmalıkta standartları yeniden belirleniyor. **Slim serisi ürünler;**
-Yalıtım bitimli kaynaksız yekpare gövde, şap yüksekliğini için yükseklik ayar seti, farklı montaj yükseklikleri ve drenaj kapasiteleri ile projelere uygun alternatif mekanik çözümler sunan, 360 derece dönebilen yüksek drenaj kapasiteli koku fermatürlü S sifon, saç tutucu, 20 cm genişliğinde bütül bant, uygulama sonrası oluşabilecek kot farklılıklarını önleyen yükseklik ayar setini uygulama kolaylığı sağlayacak şekilde standardize ederek. Tek parça ürün olarak birleştiriyor ve kullanıcılara kolay montaj avantajı sunuyor.

EBAT Size	Inox Satinox	Inox Ayna Mirror	Altın Ayna Gold	Bakır Ayna Bronze				
40 cm	DF 040 01 09 S01	154 \$	DF 040 00 09 S01	185 \$	DF 040 20 09 S01	200 \$	DF 040 30 09 S01	220 \$
50 cm	DF 050 01 09 S01	172 \$	DF 050 00 09 S01	199 \$	DF 050 20 09 S01	217 \$	DF 050 30 09 S01	239 \$
60 cm	DF 060 01 09 S01	191 \$	DF 060 00 09 S01	221 \$	DF 060 20 09 S01	240 \$	DF 060 30 09 S01	265 \$
80 cm	DF 080 01 09 S01	234 \$	DF 080 00 09 S01	256 \$	DF 080 20 09 S01	272 \$	DF 080 30 09 S01	299 \$
120 cm	DF 120 01 09 S01	323 \$	DF 120 00 09 S01	366 \$	DF 120 20 09 S01	383 \$	DF 120 30 09 S01	421 \$



Sifon Tipi : S01

EBAT Size	Inox Satinox	Inox Ayna Mirror	Altın Ayna Gold	Bakır Ayna Bronze				
40 cm	DF 040 01 09 S02	154 \$	DF 040 00 09 S02	185 \$	DF 040 20 09 S02	200 \$	DF 040 30 09 S02	220 \$
50 cm	DF 050 01 09 S02	172 \$	DF 050 00 09 S02	199 \$	DF 050 20 09 S02	217 \$	DF 050 30 09 S02	239 \$
60 cm	DF 060 01 09 S02	191 \$	DF 060 00 09 S02	221 \$	DF 060 20 09 S02	240 \$	DF 060 30 09 S02	265 \$
80 cm	DF 080 01 09 S02	234 \$	DF 080 00 09 S02	256 \$	DF 080 20 09 S02	272 \$	DF 080 30 09 S02	299 \$
120 cm	DF 120 01 09 S02	323 \$	DF 120 00 09 S02	366 \$	DF 120 20 09 S02	383 \$	DF 120 30 09 S02	421 \$



Sifon Tipi : S02

S01

h : 60 mm
Debi: 51 lt/dk - Flow: 51 lt/min
Kokusuz / Odor free



S02

h : 70 mm
Debi: 48 lt/dk - Flow: 48 lt/min
Kokusuz / Odor free



S03

h : 30/80 mm
Karot ø: 120mm -Care Drill Diameter ø: 120mm
Kokusuz / Odor free



EBAT Size	Inox Satinox		Inox Ayna Mirror		Altın Ayna Gold		Bakır Ayna Bronze	
40 cm	DF 040 01 09 S10	169 \$	DF 040 00 09 S10	200 \$	DF 040 20 09 S10	215 \$	DF 040 30 09 S10	236 \$
50 cm	DF 050 01 09 S10	187 \$	DF 050 00 09 S10	214 \$	DF 050 20 09 S10	232 \$	DF 050 30 09 S10	255 \$
60 cm	DF 060 01 09 S10	206 \$	DF 060 00 09 S10	236 \$	DF 060 20 09 S10	255 \$	DF 060 30 09 S10	280 \$
80 cm	DF 080 01 09 S10	249 \$	DF 080 00 09 S10	271 \$	DF 080 20 09 S10	287 \$	DF 080 30 09 S10	316 \$
120 cm	DF 120 01 09 S10	338 \$	DF 120 00 09 S10	381 \$	DF 120 20 09 S10	398 \$	DF 120 30 09 S10	438 \$



Sifon Tipi : S10

EBAT Size	Inox Satinox		Inox Ayna Mirror		Altın Ayna Gold		Bakır Ayna Bronze	
40 cm	DF 040 01 09 S11	169 \$	DF 040 00 09 S11	200 \$	DF 040 20 09 S11	215 \$	DF 040 30 09 S11	236 \$
50 cm	DF 050 01 09 S11	187 \$	DF 050 00 09 S11	214 \$	DF 050 20 09 S11	232 \$	DF 050 30 09 S11	255 \$
60 cm	DF 060 01 09 S11	206 \$	DF 060 00 09 S11	236 \$	DF 060 20 09 S11	255 \$	DF 060 30 09 S11	280 \$
80 cm	DF 080 01 09 S11	249 \$	DF 080 00 09 S11	271 \$	DF 080 20 09 S11	287 \$	DF 080 30 09 S11	316 \$
120 cm	DF 120 01 09 S11	338 \$	DF 120 00 09 S11	381 \$	DF 120 20 09 S11	398 \$	DF 120 30 09 S11	438 \$



Sifon Tipi : S11

EBAT Size	Inox Satinox		Inox Ayna Mirror		Altın Ayna Gold		Bakır Ayna Bronze	
40 cm	DF 040 01 09 S03	154 \$	DF 040 00 09 S03	185 \$	DF 040 20 09 S03	200 \$	DF 040 30 09 S03	220 \$
50 cm	DF 050 01 09 S03	172 \$	DF 050 00 09 S03	199 \$	DF 050 20 09 S03	217 \$	DF 050 30 09 S03	239 \$
60 cm	DF 060 01 09 S03	191 \$	DF 060 00 09 S03	221 \$	DF 060 20 09 S03	240 \$	DF 060 30 09 S03	264 \$
80 cm	DF 080 01 09 S03	234 \$	DF 080 00 09 S03	256 \$	DF 080 20 09 S03	272 \$	DF 080 30 09 S03	299 \$
120 cm	DF 120 01 09 S03	323 \$	DF 120 00 09 S03	366 \$	DF 120 20 09 S03	383 \$	DF 120 30 09 S03	421 \$



Sifon Tipi : S03

EBAT Size	Inox Satinox		Inox Ayna Mirror		Altın Ayna Gold		Bakır Ayna Bronze	
40 cm	DF 040 01 09 S08	189 \$	DF 040 00 09 S08	220 \$	DF 040 20 09 S08	235 \$	DF 040 30 09 S08	258 \$
50 cm	DF 050 01 09 S08	207 \$	DF 050 00 09 S08	234 \$	DF 050 20 09 S08	252 \$	DF 050 30 09 S08	277 \$
60 cm	DF 060 01 09 S08	226 \$	DF 060 00 09 S08	256 \$	DF 060 20 09 S08	275 \$	DF 060 30 09 S08	302 \$
80 cm	DF 080 01 09 S08	269 \$	DF 080 00 09 S08	291 \$	DF 080 20 09 S08	307 \$	DF 080 30 09 S08	338 \$
120 cm	DF 120 01 09 S08	358 \$	DF 120 00 09 S08	401 \$	DF 120 20 09 S08	418 \$	DF 120 30 09 S08	460 \$



Sifon Tipi : S08

S08

h : 30/80 mm
Karot ø: 110 mm - Care Drill Diameter ø: 110 mm
Kokusuz / Odor free



S10

h : 60 mm
Debi: 60 lt/dk - Flow: 60 lt/min
Kokusuz / Odor free



S11

h : 70 mm
Debi: 60 lt/dk - Flow: 60 lt/min
Kokusuz / Odor free



PH PREMIUM

Duř kanallarında PH Premium... Ürünün görsel zerafetiyle banyo ayrı bir keyif... PH Premium serisi 5.5 cm yüzey genişliđi sunan son teknoloji ürün ile ıslak mekanlara yepyenitadırın seçenekleri sunuyor. PH Premium yüzey genişliđi [5.5cm] slim sifon yüksekliđi [7cm]'ne sahip olan PH Premium aynı zamanda 3 farklı dekoratif renklerde üretilen ızgara çerçevesi ile tüm seramik yüzeyler ile mükemmel kombinasyon sağlıyor. Sahip olduđu yalıtım eteđi ile drenaj için mükemmel bir çözüm sunuyor. 360 derece döner sifon ile kolay montaj sağlıyor. En önemli özelliklerinden biri de ızgara çerçevesi, yükseklik ayar seti ve süzgecin aynı parçada tasarım olarak sunulması.



odor prevent
system

5 l/min

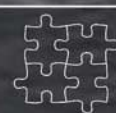

easy
assembling

304

stainles
steel



60
mm

Ø 50
output



+
+
easy
to clean



PH Premium design in shower channels... With the visual elegance of product, bathrooms offer a unique pleasure... PH Premium shower channel with its state of the art production that provides 5.5 cm surface width, PH Slim Series offer brand new design options for wet surfaces. With its grill frame produced in 3 different decorative colours, PH Premium, which has a surface width of [5.5cm] and flusher height of [5cm], stainless steel weldless single piece body, makes perfect combinations with all tile surfaces. It offers easy assembly, thanks to its 360 degree rotating flusher. One of its most important characteristics is the offering of the grill frame, height adjustment kit and the drainer within the same part as part of the design.

Uygulama Kesit :

1. Döşeme Betonunu / Covering Concrete
2. Tesviye Betonunu / Levelling Concrete
3. Ph Dizayn Butil Bant / ph design Butil Bant
4. İzolasyon Katmanı / Insulation Layer
5. Yapıştırıcı / Adhesive
6. Kaplama Malzemesi / Covering

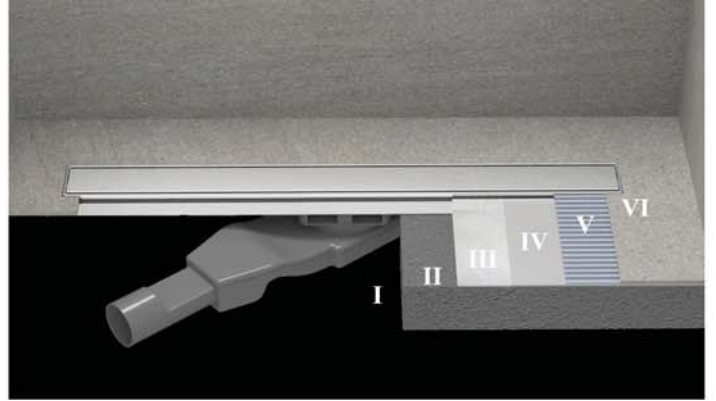

Sifon Tipi : S01

Kapak (1.5 mm kalınlık) / Top cover (1.5 mm)

Yükseklik Ayar Çerçevesi(2.5mm)/Final height adjustment frame(2.5mm)

Yükseklik Ayar Vidası / Height Adjustment Screw

Saç Tutucu Süzgeç / Hair Holder

Yalıtım Etekli Ana Gövde / Insulated Main Body

Patentli Contasız Bağlantı Parçası / Patented Without Gasket Part

360° Döner Sifon S01 / 360° Degree Rotating Flusher

Yükseklik Ayar Parçası / Height Adjustment Kit

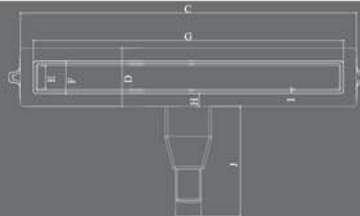
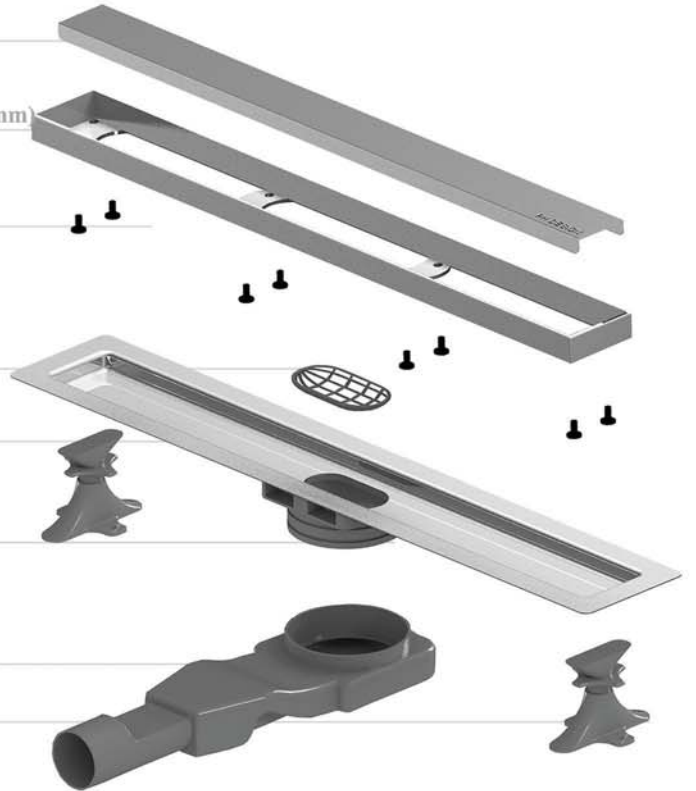

	30	40	50	60	70	80	90	100	120
A	4.3	4.3	4.3	4.3	4.3	4.3	4.3	4.3	4.3
B	6	6	6	6	6	6	6	6	6
C	35	45	55	65	75	85	95	105	125
D	11.3	11.3	11.3	11.3	11.3	11.3	11.3	11.3	11.3
E	4.5	4.5	4.5	4.5	4.5	4.5	4.5	4.5	4.5
F	6.3	6.3	6.3	6.3	6.3	6.3	6.3	6.3	6.3
G	30	40	50	60	70	80	90	100	120
H	2.5	2.5	2.5	2.5	2.5	2.5	2.5	2.5	2.5
I	3	3	3	3	3	3	3	3	3
J	21.3	21.3	21.3	21.3	21.3	21.3	21.3	21.3	21.3

Uygulama Kesit :

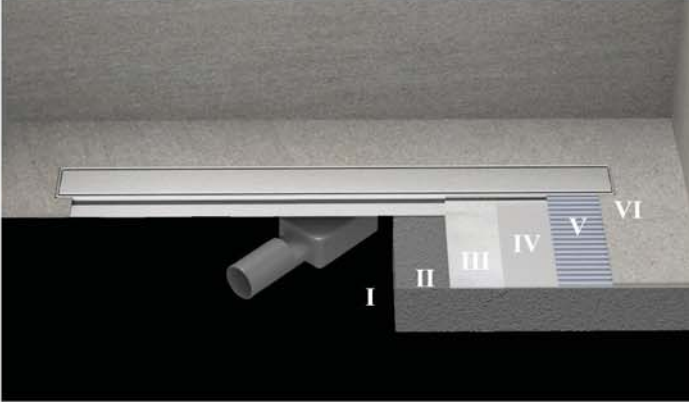

1. Döşeme Betonunu / Covering Concrete
2. Tesviye Betonunu / Levelling Concrete
3. Ph Dizayn Butil Bant / ph design Butil Bant
4. İzolasyon Katmanı / Insulation Layer
5. Yapıştırıcı / Adhesive
6. Kaplama Malzemesi / Covering

Sifon Tipi : S02

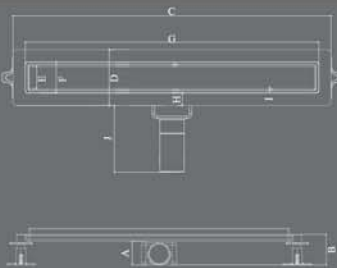
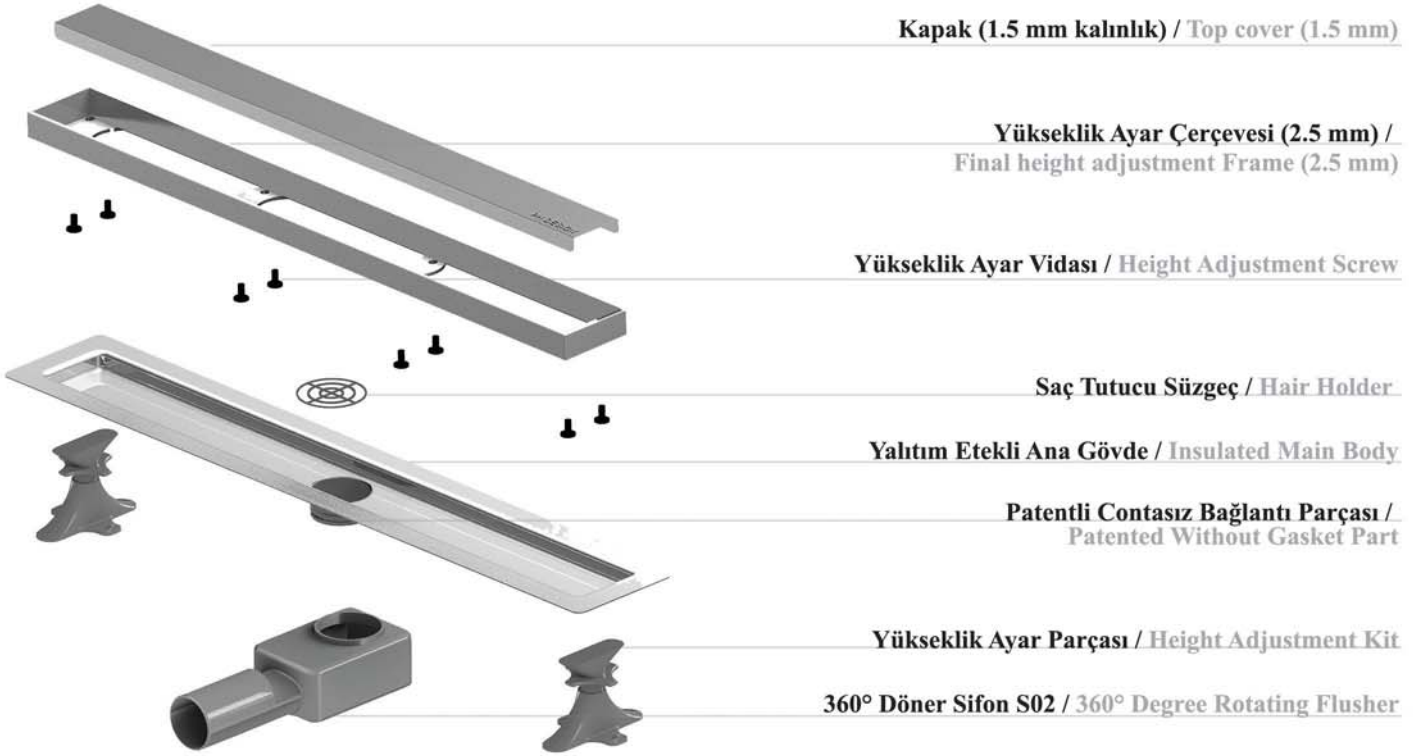

	30	40	50	60	70	80	90	100	120
A	5	5	5	5	5	5	5	5	5
B	7	7	7	7	7	7	7	7	7
C	35	45	55	65	75	85	95	105	125
D	11.3	11.3	11.3	11.3	11.3	11.3	11.3	11.3	11.3
E	4.5	4.5	4.5	4.5	4.5	4.5	4.5	4.5	4.5
F	6.3	6.3	6.3	6.3	6.3	6.3	6.3	6.3	6.3
G	30	40	50	60	70	80	90	100	120
H	2.5	2.5	2.5	2.5	2.5	2.5	2.5	2.5	2.5
I	3	3	3	3	3	3	3	3	3
J	13.5	13.5	13.5	13.5	13.5	13.5	13.5	13.5	13.5

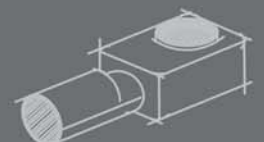

Uygulama Kesit :

1. Döşeme Betonunu / Covering Concrete
2. Tesviye Betonunu / Levelling Concrete
3. Ph Dizayn Butil Bant / ph design Butil Bant
4. İzolasyon Katmanı / Insulation Layer
5. Yapıştırıcı / Adhesive
6. Kaplama Malzemesi / Covering

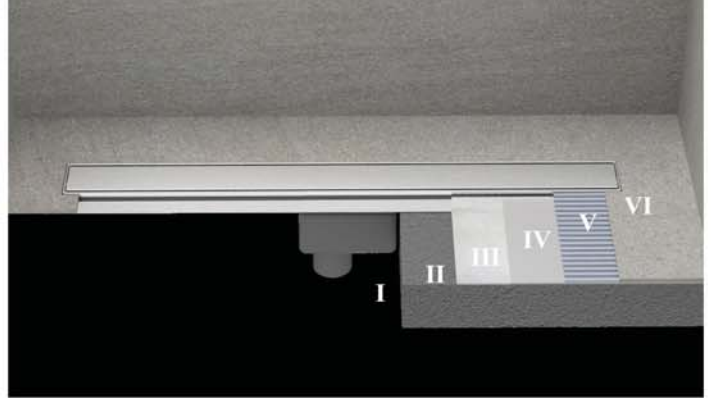

Sifon Tipi : S03

Kapak (1.5 mm kalınlık) / Top cover (1.5 mm)

Yükseklik Ayar Çerçevesi(2.5mm)/Final height adjustment frame(2.5mm)

Yükseklik Ayar Vidası / Height Adjustment Screw

Saç Tutucu Süzgeç / Hair Holder

Yalıtım Etekli Ana Gövde / Insulated Main Body

Patentli Contasız Bağlantı Parçası / Patented Without Gasket Part

360° Döner Sifon S03 / 360° Degree Rotating Flusher

Yükseklik Ayar Parçası / Height Adjustment Kit

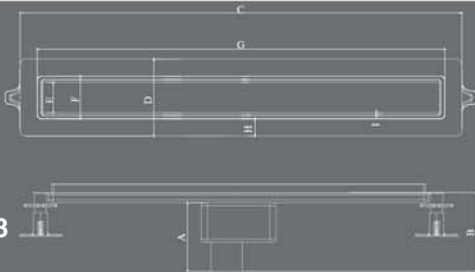
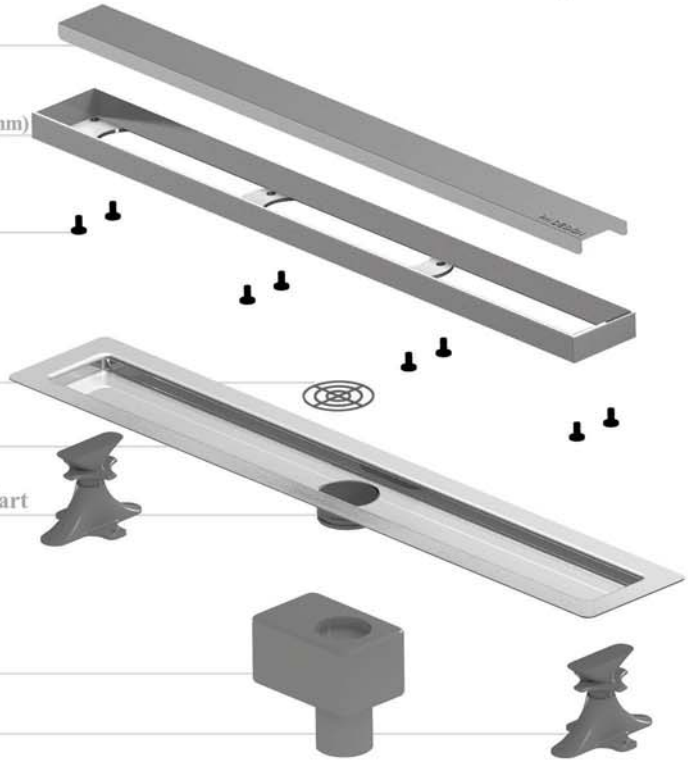

	30	40	50	60	70	80	90	100	120
A	11	11	11	11	11	11	11	11	11
B	12.6	12.6	12.6	12.6	12.6	12.6	12.6	12.6	12.6
C	35	45	55	65	75	85	95	105	125
D	11.3	11.3	11.3	11.3	11.3	11.3	11.3	11.3	11.3
E	4.5	4.5	4.5	4.5	4.5	4.5	4.5	4.5	4.5
F	6.3	6.3	6.3	6.3	6.3	6.3	6.3	6.3	6.3
G	30	40	50	60	70	80	90	100	120
H	2.5	2.5	2.5	2.5	2.5	2.5	2.5	2.5	2.5
I	3	3	3	3	3	3	3	3	3

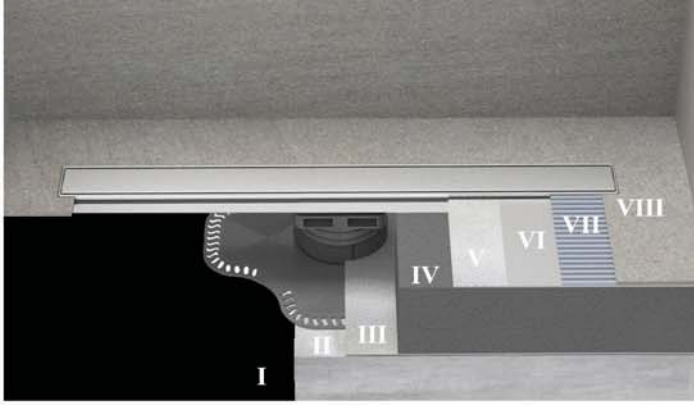

Uygulama Kesit :

1. Beton Katmanı / Concrete Layer
2. İzolasyon Katmanı / Insulation Layer
3. Döşeme Betonu / Covering Concrete
4. Tesviye Betonu / Levelling Concrete
5. Ph Dizayn Butil Bant / ph design Butil Band
6. İzolasyon Katmanı / Insulation Layer
7. Yapıştırıcı / Adhesive
8. Kaplama Malzemesi / Covering

Sifon Tipi : S08

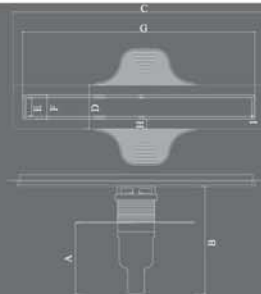
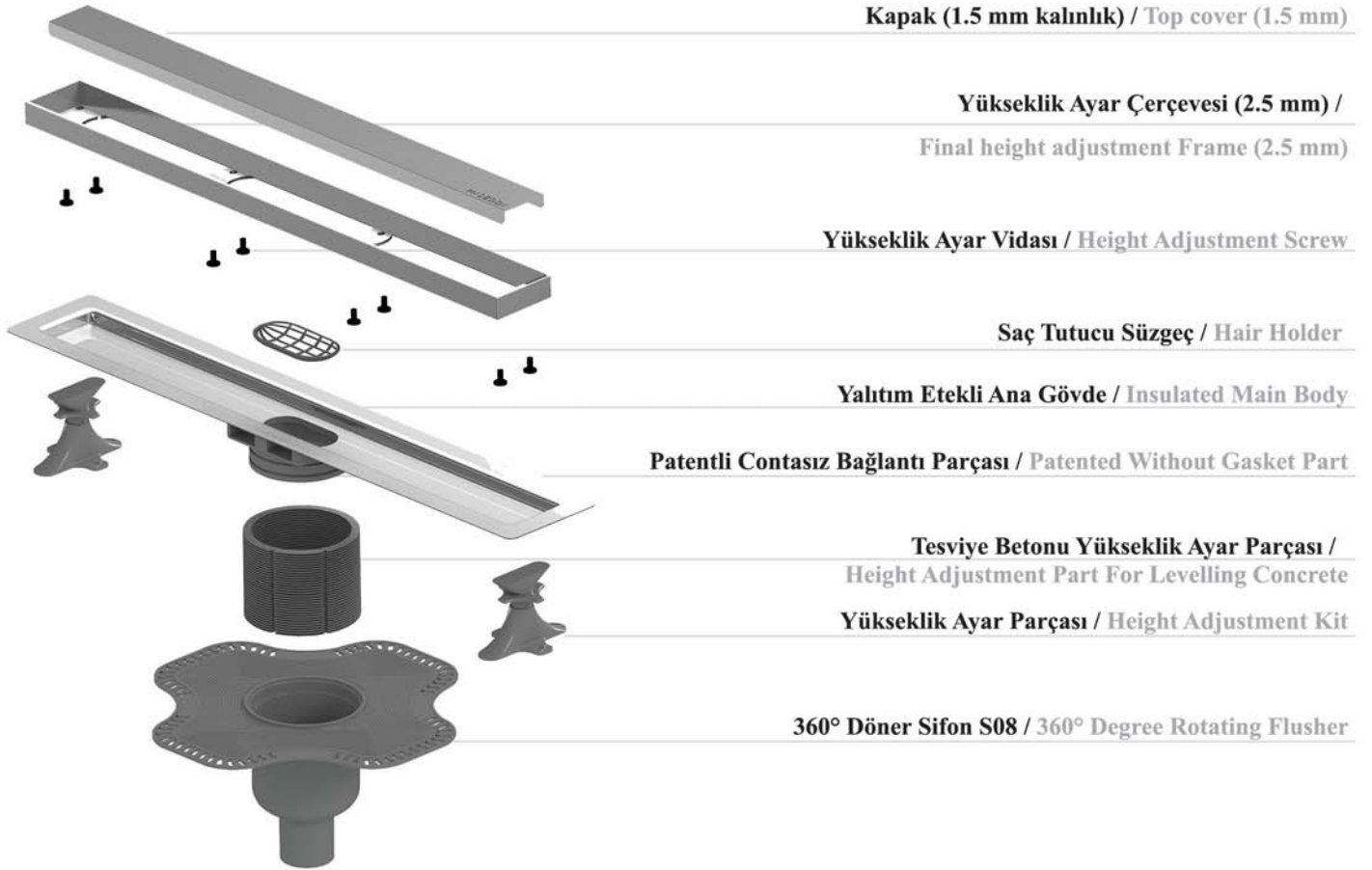

	30	40	50	60	70	80	90	100	120
A	16	16	16	16	16	16	16	16	16
B	AYARLANABİLİR	AYARLANABİLİR	AYARLANABİLİR	AYARLANABİLİR	AYARLANABİLİR	AYARLANABİLİR	AYARLANABİLİR	AYARLANABİLİR	AYARLANABİLİR
C	35	45	55	65	75	85	95	105	125
D	11.3	11.3	11.3	11.3	11.3	11.3	11.3	11.3	11.3
E	4.5	4.5	4.5	4.5	4.5	4.5	4.5	4.5	4.5
F	6.3	6.3	6.3	6.3	6.3	6.3	6.3	6.3	6.3
G	30	40	50	60	70	80	90	100	120
H	2.5	2.5	2.5	2.5	2.5	2.5	2.5	2.5	2.5
I	3	3	3	3	3	3	3	3	3
J	9.4	9.4	9.4	9.4	9.4	9.4	9.4	9.4	9.4

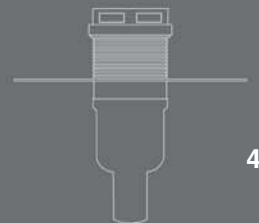

Uygulama Kesit :

1. Döşeme Betonu / Covering Concrete
2. Tesviye Betonu / Levelling Concrete
3. Ph Dizayn Butil Bant / ph design Butil Bant
4. İzolasyon Katmanı / Insulation Layer
5. Yapıştırıcı / Adhesive
6. Kaplama Malzemesi / Covering

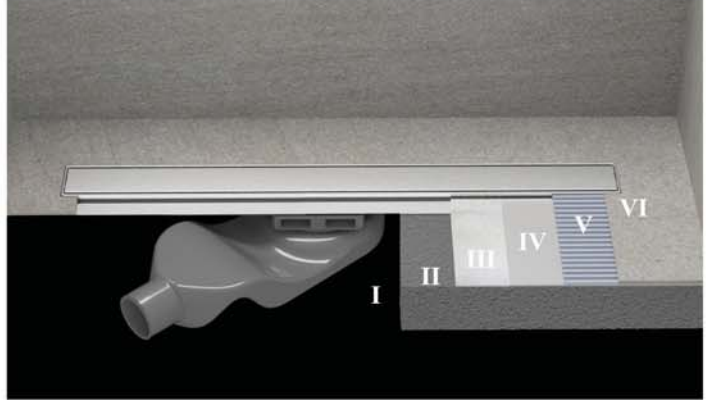

Sifon Tipi : S10

Kapak (1.5 mm kalınlık) / Top cover (1.5 mm)

Yükseklik Ayar Çerçevesi(2.5mm)/Final height adjustment frame(2.5mm)

Yükseklik Ayar Vidası / Height Adjustment Screw

Saç Tutucu Süzgeç / Hair Holder

Yalıtım Etekli Ana Gövde / Insulated Main Body

Patentli Contasız Bağlantı Parçası / Patented Without Gasket Part

360° Döner Sifon S10 / 360° Degree Rotating Flusher

Yükseklik Ayar Parçası / Height Adjustment Kit

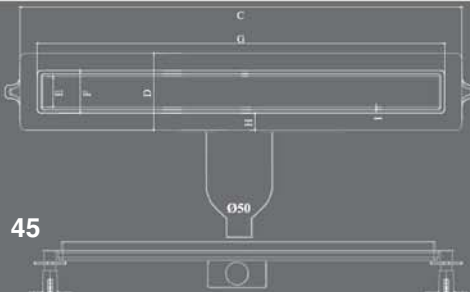
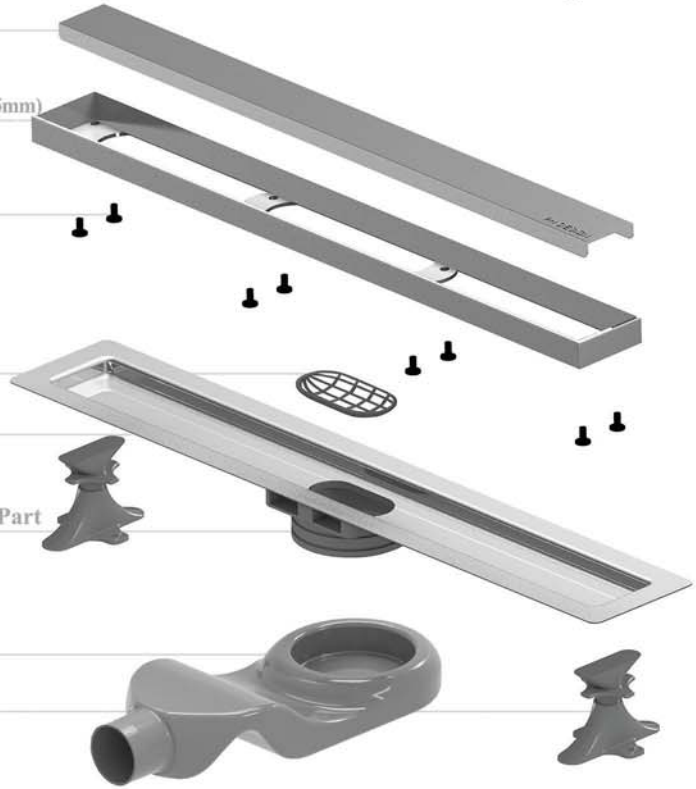

	30	40	50	60	70	80	90	100	120
A	4.3	4.3	4.3	4.3	4.3	4.3	4.3	4.3	4.3
B	6	6	6	6	6	6	6	6	6
C	35	45	55	65	75	85	95	105	125
D	11.3	11.3	11.3	11.3	11.3	11.3	11.3	11.3	11.3
E	4.5	4.5	4.5	4.5	4.5	4.5	4.5	4.5	4.5
F	6.3	6.3	6.3	6.3	6.3	6.3	6.3	6.3	6.3
G	30	40	50	60	70	80	90	100	120
H	2.5	2.5	2.5	2.5	2.5	2.5	2.5	2.5	2.5
I	3	3	3	3	3	3	3	3	3
J	21.3	21.3	21.3	21.3	21.3	21.3	21.3	21.3	21.3

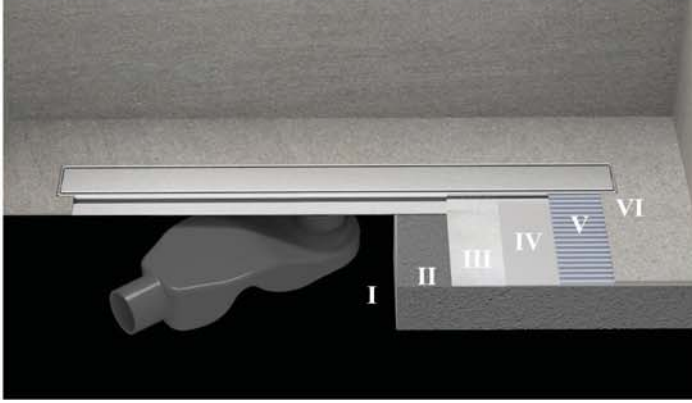

Uygulama Kesit :

1. Döşeme Betonu / Covering Concrete
2. Tesviye Betonu / Levelling Concrete
3. Ph Dizayn Butil Bant / ph design Butil Bant
4. İzolasyon Katmanı / Insulation Layer
5. Yapıştırıcı / Adhesive
6. Kaplama Malzemesi / Covering



Kapak (1.5 mm kalınlık) / Top cover (1.5 mm)

Yükseklik Ayar Çerçevesi (2.5 mm) /
Final height adjustment Frame (2.5 mm)

Yükseklik Ayar Vidası / Height Adjustment Screw

Saç Tutucu Süzgeç / Hair Holder

Yalıtım Etekli Ana Gövde / Insulated Main Body

Patentli Contasız Bağlantı Parçası /
Patented Without Gasket Part

Yükseklik Ayar Parçası / Height Adjustment Kit

360° Döner Sifon S11 / 360° Degree Rotating Flusher

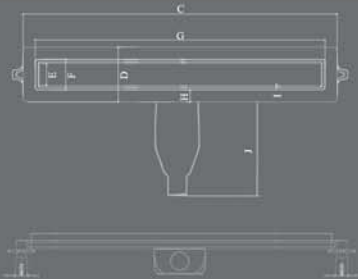

	30	40	50	60	70	80	90	100	120
A	4.3	4.3	4.3	4.3	4.3	4.3	4.3	4.3	4.3
B	6	6	6	6	6	6	6	6	6
C	35	45	55	65	75	85	95	105	125
D	11.3	11.3	11.3	11.3	11.3	11.3	11.3	11.3	11.3
E	4.5	4.5	4.5	4.5	4.5	4.5	4.5	4.5	4.5
F	6.3	6.3	6.3	6.3	6.3	6.3	6.3	6.3	6.3
G	30	40	50	60	70	80	90	100	120
H	2.5	2.5	2.5	2.5	2.5	2.5	2.5	2.5	2.5
I	3	3	3	3	3	3	3	3	3
J	21.3	21.3	21.3	21.3	21.3	21.3	21.3	21.3	21.3





PH DESIGN

Premium serisi ile duş alanlarına modern , estetik ve kullanışlı çözümler sunuyor. Hemzemin uygulama karo ile bütünleşerek engelsiz banyolar yaratıyor. Yeni teknolojiyi kullanarak PATENTLİ CONTASIZ sistem ile sızdırmalıkta standartları yeniden belirliyor.

Premium serisi ürünler;

-Yalıtım bitimli kaynaksız yekpare gövde, şap yüksekliğini için yükseklikayar seti, farklı montaj yükseklikleri ve drenaj kapasiteleri ile projelere uygun alternatif mekanik çözümler sunan, 360 derece dönebilen yüksek drenaj kapasiteli koku feramatürlü S sifon, saç tutucu, 20 cm genişliğinde bütül bant, uygulama sonrası oluşabilecek kot farklılıklarını önleyen yükseklik ayar setini uygulama kolaylığı sağlayacak şekilde standardize ederek Tek parça ürün olarak birleştiriyor ve kullanıcılara kolay montaj avantajı sunuyor.

EBAT Size	Inox Satinox	Inox Ayna Mirror	Altın Ayna Gold	Bakır Ayna Bronze
30 cm	DP 030 01 00 S01	DP 030 00 00 S01	DP 030 20 00 S01	DP 030 30 00 S01
40 cm	DP 040 01 00 S01	DP 040 00 00 S01	DP 040 20 00 S01	DP 040 30 00 S01
50 cm	DP 050 01 00 S01	DP 050 00 00 S01	DP 050 20 00 S01	DP 050 30 00 S01
60 cm	DP 060 01 00 S01	DP 060 00 00 S01	DP 060 20 00 S01	DP 060 30 00 S01
70 cm	DP 070 01 00 S01	DP 070 00 00 S01	DP 070 20 00 S01	DP 070 30 00 S01
80 cm	DP 080 01 00 S01	DP 080 00 00 S01	DP 080 20 00 S01	DP 080 30 00 S01
90 cm	DP 090 01 00 S01	DP 090 00 00 S01	DP 090 20 00 S01	DP 090 30 00 S01
100 cm	DP 100 01 00 S01	DP 100 00 00 S01	DP 100 20 00 S01	DP 100 30 00 S01
120 cm	DP 120 01 00 S01	DP 120 00 00 S01	DP 120 20 00 S01	DP 120 30 00 S01



Sifon Tipi : S01

EBAT Size	Inox Satinox	Inox Ayna Mirror	Altın Ayna Gold	Bakır Ayna Bronze
30 cm	DP 030 01 00 S02	DP 030 00 00 S02	DP 030 20 00 S02	DP 030 30 00 S02
40 cm	DP 040 01 00 S02	DP 040 00 00 S02	DP 040 20 00 S02	DP 040 30 00 S02
50 cm	DP 050 01 00 S02	DP 050 00 00 S02	DP 050 20 00 S02	DP 050 30 00 S02
60 cm	DP 060 01 00 S02	DP 060 00 00 S02	DP 060 20 00 S02	DP 060 30 00 S02
70 cm	DP 070 01 00 S02	DP 070 00 00 S02	DP 070 20 00 S02	DP 070 30 00 S02
80 cm	DP 080 01 00 S02	DP 080 00 00 S02	DP 080 20 00 S02	DP 080 30 00 S02
90 cm	DP 090 01 00 S02	DP 090 00 00 S02	DP 090 20 00 S02	DP 090 30 00 S02
100 cm	DP 100 01 00 S02	DP 100 00 00 S02	DP 100 20 00 S02	DP 100 30 00 S02
120 cm	DP 120 01 00 S02	DP 120 00 00 S02	DP 120 20 00 S02	DP 120 30 00 S02



Sifon Tipi : S02

S01

h : 60 mm
Debi: 51 lt/dk - Flow: 51 lt/min
Kokusuz / Odor free



S02

h : 70 mm
Debi: 48 lt/dk - Flow: 48 lt/min
Kokusuz / Odor free



S03

h : 30/80 mm
Karat ø: 120mm -Care Drill Diameter ø: 120mm
Kokusuz / Odor free



EBAT Size	Inox Satinox	Inox Ayna Mirror	Altın Ayna Gold	Bakır Ayna Bronze
30 cm	DP 030 01 00 S01	DP 030 00 00 S10	DP 030 20 00 S10	DP 030 30 00 S10
40 cm	DP 040 01 00 S01	DP 040 00 00 S10	DP 040 20 00 S10	DP 040 30 00 S10
50 cm	DP 050 01 00 S01	DP 050 00 00 S10	DP 050 20 00 S10	DP 050 30 00 S10
60 cm	DP 060 01 00 S01	DP 060 00 00 S10	DP 060 20 00 S10	DP 060 30 00 S10
70 cm	DP 070 01 00 S01	DP 070 00 00 S10	DP 070 20 00 S10	DP 070 30 00 S10
80 cm	DP 080 01 00 S01	DP 080 00 00 S10	DP 080 20 00 S10	DP 080 30 00 S10
90 cm	DP 090 01 00 S01	DP 090 00 00 S10	DP 090 20 00 S10	DP 090 30 00 S10
100 cm	DP 100 01 00 S01	DP 100 00 00 S10	DP 100 20 00 S10	DP 100 30 00 S10
120 cm	DP 120 01 00 S01	DP 120 00 00 S10	DP 120 20 00 S10	DP 120 30 00 S10



Sifon Tipi : S10

EBAT Size	Inox Satinox	Inox Ayna Mirror	Altın Ayna Gold	Bakır Ayna Bronze
30 cm	DP 030 01 00 S11	DP 030 00 00 S11	DP 030 20 00 S11	DP 030 30 00 S11
40 cm	DP 040 01 00 S11	DP 040 00 00 S11	DP 040 20 00 S11	DP 040 30 00 S11
50 cm	DP 050 01 00 S11	DP 050 00 00 S11	DP 050 20 00 S11	DP 050 30 00 S11
60 cm	DP 060 01 00 S11	DP 060 00 00 S11	DP 060 20 00 S11	DP 060 30 00 S11
70 cm	DP 070 01 00 S11	DP 070 00 00 S11	DP 070 20 00 S11	DP 070 30 00 S11
80 cm	DP 080 01 00 S11	DP 080 00 00 S11	DP 080 20 00 S11	DP 080 30 00 S11
90 cm	DP 090 01 00 S11	DP 090 00 00 S11	DP 090 20 00 S11	DP 090 30 00 S11
100 cm	DP 100 01 00 S11	DP 100 00 00 S11	DP 100 20 00 S11	DP 100 30 00 S11
120 cm	DP 120 01 00 S11	DP 120 00 00 S11	DP 120 20 00 S11	DP 120 30 00 S11



Sifon Tipi : S11

EBAT Size	Inox Satinox	Inox Ayna Mirror	Altın Ayna Gold	Bakır Ayna Bronze
30 cm	DP 030 01 00 S03	DP 030 00 00 S03	DP 030 20 00 S03	DP 030 30 00 S03
40 cm	DP 040 01 00 S03	DP 040 00 00 S03	DP 040 20 00 S03	DP 040 30 00 S03
50 cm	DP 050 01 00 S03	DP 050 00 00 S03	DP 050 20 00 S03	DP 050 30 00 S03
60 cm	DP 060 01 00 S03	DP 060 00 00 S03	DP 060 20 00 S03	DP 060 30 00 S03
70 cm	DP 070 01 00 S03	DP 070 00 00 S03	DP 070 20 00 S03	DP 070 30 00 S03
80 cm	DP 080 01 00 S03	DP 080 00 00 S03	DP 080 20 00 S03	DP 080 30 00 S03
90 cm	DP 090 01 00 S03	DP 090 00 00 S03	DP 090 20 00 S03	DP 090 30 00 S03
100 cm	DP 100 01 00 S03	DP 100 00 00 S03	DP 100 20 00 S03	DP 100 30 00 S03
120 cm	DP 120 01 00 S03	DP 120 00 00 S03	DP 120 20 00 S03	DP 120 30 00 S03



Sifon Tipi : S03

EBAT Size	Inox Satinox	Inox Ayna Mirror	Altın Ayna Gold	Bakır Ayna Bronze
30 cm	DP 030 01 00 S08	DP 030 00 00 S08	DP 030 20 00 S08	DP 030 30 00 S08
40 cm	DP 040 01 00 S08	DP 040 00 00 S08	DP 040 20 00 S08	DP 040 30 00 S08
50 cm	DP 050 01 00 S08	DP 050 00 00 S08	DP 050 20 00 S08	DP 050 30 00 S08
60 cm	DP 060 01 00 S08	DP 060 00 00 S08	DP 060 20 00 S08	DP 060 30 00 S08
70 cm	DP 070 01 00 S08	DP 070 00 00 S08	DP 070 20 00 S08	DP 070 30 00 S08
80 cm	DP 080 01 00 S08	DP 080 00 00 S08	DP 080 20 00 S08	DP 080 30 00 S08
90 cm	DP 090 01 00 S08	DP 090 00 00 S08	DP 090 20 00 S08	DP 090 30 00 S08
100 cm	DP 100 01 00 S08	DP 100 00 00 S08	DP 100 20 00 S08	DP 100 30 00 S08
120 cm	DP 120 01 00 S08	DP 120 00 00 S08	DP 120 20 00 S08	DP 120 30 00 S08



Sifon Tipi : S08

S08

h : 30/80 mm
Karat : 110 mm - Care Drill Diameter : 110 mm
Kokusuz / Odor free



S10

h : 60 mm
Debi: 60 lt/dk - Flow: 60 lt/min
Kokusuz / Odor free



S11

h : 70 mm
Debi: 60 lt/dk - Flow: 60 lt/min
Kokusuz / Odor free





PH DESIGN

Premium serisi ile duş alanlarına modern , estetik ve kullanışlı çözümler sunuyor. Hemzemin uygulama karo ile bütünleşerek engelsiz banyolar yaratıyor. Yeni teknolojiyi kullanarak PATENTLİ CONTASIZ sistem ile sızdırmalıkta standartları yeniden belirleniyor.

Premium serisi ürünler;

-Yalıtım bitimli kaynaksız yekpare gövde, şap yüksekliğini için yükseklikayar seti, farklı montaj yükseklikleri ve drenaj kapasiteleri ile projelere uygun alternatif mekanik çözümler sunan, 360 derece dönebilen yüksek drenaj kapasiteli koku fermatürlü S sifon, saç tutucu, 20 cm genişliğinde bütül bant, uygulama sonrası oluşabilecek kot farklılıklarını önleyen yükseklik ayar setini uygulama kolaylığı sağlayacak şekilde standardize ederek Tek parça ürün olarak birleştiriyor ve kullanıcılara kolay montaj avantajı sunuyor.

EBAT Size	Seramik Ceramic	Mermer Marble
30 cm	DP 030 01 06 S01 105 \$	DP 030 01 02 S01 130 \$
40 cm	DP 040 01 06 S01 122 \$	DP 040 01 02 S01 151 \$
50 cm	DP 050 01 06 S01 136 \$	DP 050 01 02 S01 168 \$
60 cm	DP 060 01 06 S01 151 \$	DP 060 01 02 S01 187 \$
70 cm	DP 070 01 06 S01 166 \$	DP 070 01 02 S01 205 \$
80 cm	DP 080 01 06 S01 185 \$	DP 080 01 02 S01 229 \$
90 cm	DP 090 01 06 S01 211 \$	DP 090 01 02 S01 261 \$
100 cm	DP 100 01 06 S01 227 \$	DP 100 01 02 S01 281 \$
120 cm	DP 120 01 06 S01 255 \$	DP 120 01 02 S01 316 \$

EBAT Size	Seramik Ceramic	Mermer Marble
30 cm	DP 030 01 06 S02 105 \$	DP 030 01 02 S02 130 \$
40 cm	DP 040 01 06 S02 122 \$	DP 040 01 02 S02 151 \$
50 cm	DP 050 01 06 S02 136 \$	DP 050 01 02 S02 168 \$
60 cm	DP 060 01 06 S02 151 \$	DP 060 01 02 S02 187 \$
70 cm	DP 070 01 06 S02 166 \$	DP 070 01 02 S02 205 \$
80 cm	DP 080 01 06 S02 185 \$	DP 080 01 02 S02 229 \$
90 cm	DP 090 01 06 S02 211 \$	DP 090 01 02 S02 261 \$
100 cm	DP 100 01 06 S02 227 \$	DP 100 01 02 S02 281 \$
120 cm	DP 120 01 06 S02 255 \$	DP 120 01 02 S02 316 \$



Sifon Tipi : S01



Sifon Tipi : S02

S01

h : 60 mm
Debi: 51 lt/dk - Flow: 51 lt/min
Kokusuz / Odor free



S02

h : 70 mm
Debi: 48 lt/dk - Flow: 48 lt/min
Kokusuz / Odor free



S03

h : 30/80 mm
Karat ø: 120mm -Care Drill Diameter ø: 120mm
Kokusuz / Odor free



EBAT Size	Seramik Ceramic	Mermer Marble
30 cm	DP 030 01 06 S10 120 \$	DP 030 01 02 S10 146 \$
40 cm	DP 040 01 06 S10 137 \$	DP 040 01 02 S10 167 \$
50 cm	DP 050 01 06 S10 151 \$	DP 050 01 02 S10 185 \$
60 cm	DP 060 01 06 S10 166 \$	DP 060 01 02 S10 203 \$
70 cm	DP 070 01 06 S10 181 \$	DP 070 01 02 S10 222 \$
80 cm	DP 080 01 06 S10 200 \$	DP 080 01 02 S10 245 \$
90 cm	DP 090 01 06 S10 226 \$	DP 090 01 02 S10 278 \$
100 cm	DP 100 01 06 S10 242 \$	DP 100 01 02 S10 297 \$
120 cm	DP 120 01 06 S10 270 \$	DP 120 01 02 S10 332 \$

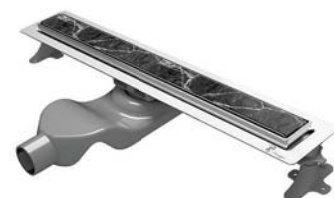

Sifon Tipi : S10

EBAT Size	Seramik Ceramic	Mermer Marble
30 cm	DP 030 01 06 S11 120 \$	DP 030 01 02 S11 146 \$
40 cm	DP 040 01 06 S11 137 \$	DP 040 01 02 S11 167 \$
50 cm	DP 050 01 06 S11 151 \$	DP 050 01 02 S11 185 \$
60 cm	DP 060 01 06 S11 166 \$	DP 060 01 02 S11 203 \$
70 cm	DP 070 01 06 S11 181 \$	DP 070 01 02 S11 222 \$
80 cm	DP 080 01 06 S11 200 \$	DP 080 01 02 S11 245 \$
90 cm	DP 090 01 06 S11 226 \$	DP 090 01 02 S11 278 \$
100 cm	DP 100 01 06 S11 242 \$	DP 100 01 02 S11 297 \$
120 cm	DP 120 01 06 S11 270 \$	DP 120 01 02 S11 332 \$



Sifon Tipi : S11

EBAT Size	Seramik Ceramic	Mermer Marble
30 cm	DP 030 01 06 S03 105 \$	DP 030 01 02 S03 130 \$
40 cm	DP 040 01 06 S03 122 \$	DP 040 01 02 S03 151 \$
50 cm	DP 050 01 06 S03 136 \$	DP 050 01 02 S03 168 \$
60 cm	DP 060 01 06 S03 151 \$	DP 060 01 02 S03 187 \$
70 cm	DP 070 01 06 S03 166 \$	DP 070 01 02 S03 205 \$
80 cm	DP 080 01 06 S03 185 \$	DP 080 01 02 S03 229 \$
90 cm	DP 090 01 06 S03 211 \$	DP 090 01 02 S03 261 \$
100 cm	DP 100 01 06 S03 227 \$	DP 100 01 02 S03 281 \$
120 cm	DP 120 01 06 S03 255 \$	DP 120 01 02 S03 316 \$



Sifon Tipi : S03

EBAT Size	Seramik Ceramic	Mermer Marble
30 cm	DP 030 01 06 S08 140 \$	DP 030 01 02 S08 168 \$
40 cm	DP 040 01 06 S08 157 \$	DP 040 01 02 S08 189 \$
50 cm	DP 050 01 06 S08 171 \$	DP 050 01 02 S08 207 \$
60 cm	DP 060 01 06 S08 186 \$	DP 060 01 02 S08 225 \$
70 cm	DP 070 01 06 S08 201 \$	DP 070 01 02 S08 244 \$
80 cm	DP 080 01 06 S08 220 \$	DP 080 01 02 S08 267 \$
90 cm	DP 090 01 06 S08 246 \$	DP 090 01 02 S08 300 \$
100 cm	DP 100 01 06 S08 262 \$	DP 100 01 02 S08 319 \$
120 cm	DP 120 01 06 S08 290 \$	DP 120 01 02 S08 354 \$



Sifon Tipi : S08

S08

h : 30/80 mm
Karot ø : 110 mm - Core Drill Diameter ø : 110 mm
Kokusuz / Odor free



S10

h : 60 mm
Debi: 60 lt/dk - Flow: 60 lt/min
Kokusuz / Odor free



S11

h : 70 mm
Debi: 60 lt/dk - Flow: 60 lt/min
Kokusuz / Odor free





PH DESIGN

Premium serisi ile duş alanlarına modern , estetik ve kullanışlı çözümler sunuyor. Hemzemin uygulama karo ile bütünleşerek engelsiz banyolar yaratıyor. Yeni teknolojiyi kullanarak PATENTLİ CONTASIZ sistem ile sızdırmalıkta standartları yeniden belirleniyor.

Premium serisi ürünler;

-Yalıtım bitimli kaynaksız yekpare gövde, şap yüksekliğini için yükseklikayar seti, farklı montaj yükseklikleri ve drenaj kapasiteleri ile projelere uygun alternatif mekanik çözümler sunan, 360 derece dönebilen yüksek drenaj kapasiteli koku fermatürlü S sifon, saç tutucu, 20 cm genişliğinde bütül bant, uygulama sonrası oluşabilecek kot farklılıklarını önleyen yükseklik ayar setini uygulama kolaylığı sağlayacak şekilde standardize ederek Tek parça ürün olarak birleştiriyor ve kullanıcılara kolay montaj avantajı sunuyor.

EBAT Size	Inox Satinox	Inox Ayna Mirror	Altın Ayna Gold	Bakır Ayna Bronze
30 cm	DP 030 01 01 S01	DP 030 00 01 S01	DP 030 20 01 S01	DP 030 30 01 S01
40 cm	DP 040 01 01 S01	DP 040 00 01 S01	DP 040 20 01 S01	DP 040 30 01 S01
50 cm	DP 050 01 01 S01	DP 050 00 01 S01	DP 050 20 01 S01	DP 050 30 01 S01
60 cm	DP 060 01 01 S01	DP 060 00 01 S01	DP 060 20 01 S01	DP 060 30 01 S01
70 cm	DP 070 01 01 S01	DP 070 00 01 S01	DP 070 20 01 S01	DP 070 30 01 S01
80 cm	DP 080 01 01 S01	DP 080 00 01 S01	DP 080 20 01 S01	DP 080 30 01 S01
90 cm	DP 090 01 01 S01	DP 090 00 01 S01	DP 090 20 01 S01	DP 090 30 01 S01
100 cm	DP 100 01 01 S01	DP 100 00 01 S01	DP 100 20 01 S01	DP 100 30 01 S01
120 cm	DP 120 01 01 S01	DP 120 00 01 S01	DP 120 20 01 S01	DP 120 30 01 S01



Sifon Tipi : S01

EBAT Size	Inox Satinox	Inox Ayna Mirror	Altın Ayna Gold	Bakır Ayna Bronze
30 cm	DP 030 01 01 S02	DP 030 00 01 S02	DP 030 20 01 S02	DP 030 30 01 S02
40 cm	DP 040 01 01 S02	DP 040 00 01 S02	DP 040 20 01 S02	DP 040 30 01 S02
50 cm	DP 050 01 01 S02	DP 050 00 01 S02	DP 050 20 01 S02	DP 050 30 01 S02
60 cm	DP 060 01 01 S02	DP 060 00 01 S02	DP 060 20 01 S02	DP 060 30 01 S02
70 cm	DP 070 01 01 S02	DP 070 00 01 S02	DP 070 20 01 S02	DP 070 30 01 S02
80 cm	DP 080 01 01 S02	DP 080 00 01 S02	DP 080 20 01 S02	DP 080 30 01 S02
90 cm	DP 090 01 01 S02	DP 090 00 01 S02	DP 090 20 01 S02	DP 090 30 01 S02
100 cm	DP 100 01 01 S02	DP 100 00 01 S02	DP 100 20 01 S02	DP 100 30 01 S02
120 cm	DP 120 01 01 S02	DP 120 00 01 S02	DP 120 20 01 S02	DP 120 30 01 S02



Sifon Tipi : S02

S01

h : 60 mm
Debi: 51 lt/dk - Flow: 51 lt/min
Kokusuz / Odor free



S02

h : 70 mm
Debi: 48 lt/dk - Flow: 48 lt/min
Kokusuz / Odor free



S03

h : 30/80 mm
Karat ø: 120mm -Care Drill Diameter ø: 120mm
Kokusuz / Odor free





PH DESIGN

Premium serisi ile duş alanlarına modern , estetik ve kullanışlı çözümler sunuyor. Hemzemin uygulama karo ile bütünleşerek engelsiz banyolar yaratıyor. Yeni teknolojiyi kullanarak PATENTLİ CONTASIZ sistem ile sızdırmalıkta standartları yeniden belirliyor.

Premium serisi ürünler;

-Yalıtım bitimli kaynaksız yekpare gövde, şap yüksekliğini için yükseklikayar seti, farklı montaj yükseklikleri ve drenaj kapasiteleri ile projelere uygun alternatif mekanik çözümler sunan, 360 derece dönebilen yüksek drenaj kapasiteli koku fermatürlü S sifon, saç tutucu, 20 cm genişliğinde bütül bant, uygulama sonrası oluşabilecek kot farklılıklarını önleyen yükseklik ayar setini uygulama kolaylığı sağlayacak şekilde standardize ederek Tek parça ürün olarak birleştiriyor ve kullanıcılara kolay montaj avantajı sunuyor.

EBAT Size	Inox Satinox	Inox Ayna Mirror	Altın Ayna Gold	Bakır Ayna Bronze
30 cm	DP 030 01 01 S01 122 \$	DP 030 00 01 S01 141 \$	DP 030 20 01 S01 154 \$	DP 030 30 01 S01 185 \$
40 cm	DP 040 01 01 S01 142 \$	DP 040 00 01 S01 153 \$	DP 040 20 01 S01 166 \$	DP 040 30 01 S01 199 \$
50 cm	DP 050 01 01 S01 156 \$	DP 050 00 01 S01 169 \$	DP 050 20 01 S01 183 \$	DP 050 30 01 S01 220 \$
60 cm	DP 060 01 01 S01 183 \$	DP 060 00 01 S01 196 \$	DP 060 20 01 S01 209 \$	DP 060 30 01 S01 251 \$
70 cm	DP 070 01 01 S01 200 \$	DP 070 00 01 S01 223 \$	DP 070 20 01 S01 233 \$	DP 070 30 01 S01 280 \$
80 cm	DP 080 01 01 S01 219 \$	DP 080 00 01 S01 233 \$	DP 080 20 01 S01 249 \$	DP 080 30 01 S01 299 \$
90 cm	DP 090 01 01 S01 249 \$	DP 090 00 01 S01 275 \$	DP 090 20 01 S01 287 \$	DP 090 30 01 S01 344 \$
100 cm	DP 100 01 01 S01 272 \$	DP 100 00 01 S01 297 \$	DP 100 20 01 S01 311 \$	DP 100 30 01 S01 373 \$
120 cm	DP 120 01 01 S01 311 \$	DP 120 00 01 S01 338 \$	DP 120 20 01 S01 351 \$	DP 120 30 01 S01 421 \$



Sifon Tipi : S01

EBAT Size	Inox Satinox	Inox Ayna Mirror	Altın Ayna Gold	Bakır Ayna Bronze
30 cm	DP 030 01 01 S02 122 \$	DP 030 00 01 S02 141 \$	DP 030 20 01 S02 154 \$	DP 030 30 01 S02 185 \$
40 cm	DP 040 01 01 S02 142 \$	DP 040 00 01 S02 153 \$	DP 040 20 01 S02 166 \$	DP 040 30 01 S02 199 \$
50 cm	DP 050 01 01 S02 156 \$	DP 050 00 01 S02 169 \$	DP 050 20 01 S02 183 \$	DP 050 30 01 S02 220 \$
60 cm	DP 060 01 01 S02 183 \$	DP 060 00 01 S02 196 \$	DP 060 20 01 S02 209 \$	DP 060 30 01 S02 251 \$
70 cm	DP 070 01 01 S02 200 \$	DP 070 00 01 S02 223 \$	DP 070 20 01 S02 233 \$	DP 070 30 01 S02 280 \$
80 cm	DP 080 01 01 S02 219 \$	DP 080 00 01 S02 233 \$	DP 080 20 01 S02 249 \$	DP 080 30 01 S02 299 \$
90 cm	DP 090 01 01 S02 249 \$	DP 090 00 01 S02 275 \$	DP 090 20 01 S02 287 \$	DP 090 30 01 S02 344 \$
100 cm	DP 100 01 01 S02 272 \$	DP 100 00 01 S02 297 \$	DP 100 20 01 S02 311 \$	DP 100 30 01 S02 373 \$
120 cm	DP 120 01 01 S02 311 \$	DP 120 00 01 S02 338 \$	DP 120 20 01 S02 351 \$	DP 120 30 01 S02 421 \$



Sifon Tipi : S02

S01

h : 60 mm
Debi: 51 lt/dk - Flow: 51 lt/min
Kokusuz / Odor free



S02

h : 70 mm
Debi: 48 lt/dk - Flow: 48 lt/min
Kokusuz / Odor free

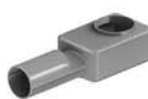

S03

h : 30/80 mm
Karot ø: 120mm -Care Drill Diameter ø: 120mm
Kokusuz / Odor free



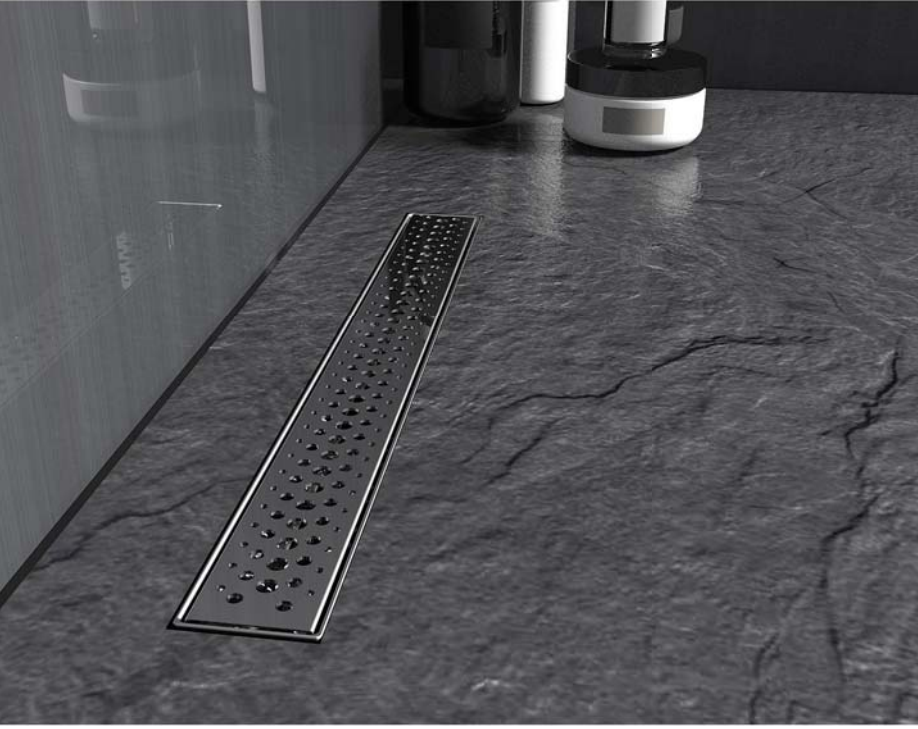

PH DESIGN

Premium serisi ile duş alanlarına modern , estetik ve kullanışlı çözümler sunuyor. Hemzemin uygulama karo ile bütünleşerek engelsiz banyolar yaratıyor. Yeni teknolojiyi kullanarak PATENTLİ CONTASIZ sistem ile sızdırmalıkta standartları yeniden belirliyor.

Premium serisi ürünler;

-Yalıtım bitimli kaynaksız yekpare gövde, şap yüksekliğini için yükseklikayar seti, farklı montaj yükseklikleri ve drenaj kapasiteleri ile projelere uygun alternatif mekanik çözümler sunan, 360 derece dönebilen yüksek drenaj kapasiteli koku fermatürlü S sifon, saç tutucu, 20 cm genişliğinde bütül bant, uygulama sonrası oluşabilecek kot farklılıklarını önleyen yükseklik ayar setini uygulama kolaylığı sağlayacak şekilde standardize ederek Tek parça ürün olarak birleştiriyor ve kullanıcılara kolay montaj avantajı sunuyor.

EBAT Size	Inox Satinox	Inox Ayna Mirror	Altın Ayna Gold	Bakır Ayna Bronze
30 cm	DP 030 01 03 S01	122 \$ DP 030 00 03 S01	141 \$ DP 030 20 03 S01	154 \$ DP 030 30 03 S01
40 cm	DP 040 01 03 S01	142 \$ DP 040 00 03 S01	153 \$ DP 040 20 03 S01	166 \$ DP 040 30 03 S01
50 cm	DP 050 01 03 S01	156 \$ DP 050 00 03 S01	169 \$ DP 050 20 03 S01	183 \$ DP 050 30 03 S01
60 cm	DP 060 01 03 S01	183 \$ DP 060 00 03 S01	196 \$ DP 060 20 03 S01	209 \$ DP 060 30 03 S01
70 cm	DP 070 01 03 S01	200 \$ DP 070 00 03 S01	223 \$ DP 070 20 03 S01	233 \$ DP 070 30 03 S01
80 cm	DP 080 01 03 S01	219 \$ DP 080 00 03 S01	233 \$ DP 080 20 03 S01	249 \$ DP 080 30 03 S01
90 cm	DP 090 01 03 S01	249 \$ DP 090 00 03 S01	275 \$ DP 090 20 03 S01	287 \$ DP 090 30 03 S01
100 cm	DP 100 01 03 S01	272 \$ DP 100 00 03 S01	297 \$ DP 100 20 03 S01	311 \$ DP 100 30 03 S01
120 cm	DP 120 01 03 S01	311 \$ DP 120 00 03 S01	338 \$ DP 120 20 03 S01	351 \$ DP 120 30 03 S01



Sifon Tipi : S01

EBAT Size	Inox Satinox	Inox Ayna Mirror	Altın Ayna Gold	Bakır Ayna Bronze
30 cm	DP 030 01 03 S02	122 \$ DP 030 00 03 S02	141 \$ DP 030 20 03 S02	154 \$ DP 030 30 03 S02
40 cm	DP 040 01 03 S02	142 \$ DP 040 00 03 S02	153 \$ DP 040 20 03 S02	166 \$ DP 040 30 03 S02
50 cm	DP 050 01 03 S02	156 \$ DP 050 00 03 S02	169 \$ DP 050 20 03 S02	183 \$ DP 050 30 03 S02
60 cm	DP 060 01 03 S02	183 \$ DP 060 00 03 S02	196 \$ DP 060 20 03 S02	209 \$ DP 060 30 03 S02
70 cm	DP 070 01 03 S02	200 \$ DP 070 00 03 S02	223 \$ DP 070 20 03 S02	233 \$ DP 070 30 03 S02
80 cm	DP 080 01 03 S02	219 \$ DP 080 00 03 S02	233 \$ DP 080 20 03 S02	249 \$ DP 080 30 03 S02
90 cm	DP 090 01 03 S02	249 \$ DP 090 00 03 S02	275 \$ DP 090 20 03 S02	287 \$ DP 090 30 03 S02
100 cm	DP 100 01 03 S02	272 \$ DP 100 00 03 S02	297 \$ DP 100 20 03 S02	311 \$ DP 100 30 03 S02
120 cm	DP 120 01 03 S02	311 \$ DP 120 00 03 S02	338 \$ DP 120 20 03 S02	351 \$ DP 120 30 03 S02



Sifon Tipi : S02

S01

h : 60 mm
Debi: 51 lt/dk - Flow: 51 lt/min
Kokusuz / Odor free



S02

h : 70 mm
Debi: 48 lt/dk - Flow: 48 lt/min
Kokusuz / Odor free



S03

h : 30/80 mm
Karat ø: 120mm -Care Drill Diameter ø: 120mm
Kokusuz / Odor free



EBAT Size	Inox Satinox	Inox Ayna Mirror	Altın Ayna Gold	Bakır Ayna Bronze
30 cm	DP 030 01 03 S10	DP 030 00 03 S10	DP 030 20 03 S10	DP 030 30 03 S10
40 cm	DP 040 01 03 S10	DP 040 00 03 S10	DP 040 20 03 S10	DP 040 30 03 S10
50 cm	DP 050 01 03 S10	DP 050 00 03 S10	DP 050 20 03 S10	DP 050 30 03 S10
60 cm	DP 060 01 03 S10	DP 060 00 03 S10	DP 060 20 03 S10	DP 060 30 03 S10
70 cm	DP 070 01 03 S10	DP 070 00 03 S10	DP 070 20 03 S10	DP 070 30 03 S10
80 cm	DP 080 01 03 S10	DP 080 00 03 S10	DP 080 20 03 S10	DP 080 30 03 S10
90 cm	DP 090 01 03 S10	DP 090 00 03 S10	DP 090 20 03 S10	DP 090 30 03 S10
100 cm	DP 100 01 03 S10	DP 100 00 03 S10	DP 100 20 03 S10	DP 100 30 03 S10
120 cm	DP 120 01 03 S10	DP 120 00 03 S10	DP 120 20 03 S10	DP 120 30 03 S10

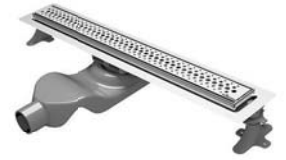

Sifon Tipi : S10

EBAT Size	Inox Satinox	Inox Ayna Mirror	Altın Ayna Gold	Bakır Ayna Bronze
30 cm	DP 030 01 03 S11	DP 030 00 03 S11	DP 030 20 03 S11	DP 030 30 03 S11
40 cm	DP 040 01 03 S11	DP 040 00 03 S11	DP 040 20 03 S11	DP 040 30 03 S11
50 cm	DP 050 01 03 S11	DP 050 00 03 S11	DP 050 20 03 S11	DP 050 30 03 S11
60 cm	DP 060 01 03 S11	DP 060 00 03 S11	DP 060 20 03 S11	DP 060 30 03 S11
70 cm	DP 070 01 03 S11	DP 070 00 03 S11	DP 070 20 03 S11	DP 070 30 03 S11
80 cm	DP 080 01 03 S11	DP 080 00 03 S11	DP 080 20 03 S11	DP 080 30 03 S11
90 cm	DP 090 01 03 S11	DP 090 00 03 S11	DP 090 20 03 S11	DP 090 30 03 S11
100 cm	DP 100 01 03 S11	DP 100 00 03 S11	DP 100 20 03 S11	DP 100 30 03 S11
120 cm	DP 120 01 03 S11	DP 120 00 03 S11	DP 120 20 03 S11	DP 120 30 03 S11



Sifon Tipi : S11

EBAT Size	Inox Satinox	Inox Ayna Mirror	Altın Ayna Gold	Bakır Ayna Bronze
30 cm	DP 030 01 03 S03	DP 030 00 03 S03	DP 030 20 03 S03	DP 030 30 03 S03
40 cm	DP 040 01 03 S03	DP 040 00 03 S03	DP 040 20 03 S03	DP 040 30 03 S03
50 cm	DP 050 01 03 S03	DP 050 00 03 S03	DP 050 20 03 S03	DP 050 30 03 S03
60 cm	DP 060 01 03 S03	DP 060 00 03 S03	DP 060 20 03 S03	DP 060 30 03 S03
70 cm	DP 070 01 03 S03	DP 070 00 03 S03	DP 070 20 03 S03	DP 070 30 03 S03
80 cm	DP 080 01 03 S03	DP 080 00 03 S03	DP 080 20 03 S03	DP 080 30 03 S03
90 cm	DP 090 01 03 S03	DP 090 00 03 S03	DP 090 20 03 S03	DP 090 30 03 S03
100 cm	DP 100 01 03 S03	DP 100 00 03 S03	DP 100 20 03 S03	DP 100 30 03 S03
120 cm	DP 120 01 03 S03	DP 120 00 03 S03	DP 120 20 03 S03	DP 120 30 03 S03



Sifon Tipi : S03

EBAT Size	Inox Satinox	Inox Ayna Mirror	Altın Ayna Gold	Bakır Ayna Bronze
30 cm	DP 030 01 03 S08	DP 030 00 03 S08	DP 030 20 03 S08	DP 030 30 03 S08
40 cm	DP 040 01 03 S08	DP 040 00 03 S08	DP 040 20 03 S08	DP 040 30 03 S08
50 cm	DP 050 01 03 S08	DP 050 00 03 S08	DP 050 20 03 S08	DP 050 30 03 S08
60 cm	DP 060 01 03 S08	DP 060 00 03 S08	DP 060 20 03 S08	DP 060 30 03 S08
70 cm	DP 070 01 03 S08	DP 070 00 03 S08	DP 070 20 03 S08	DP 070 30 03 S08
80 cm	DP 080 01 03 S08	DP 080 00 03 S08	DP 080 20 03 S08	DP 080 30 03 S08
90 cm	DP 090 01 03 S08	DP 090 00 03 S08	DP 090 20 03 S08	DP 090 30 03 S08
100 cm	DP 100 01 03 S08	DP 100 00 03 S08	DP 100 20 03 S08	DP 100 30 03 S08
120 cm	DP 120 01 03 S08	DP 120 00 03 S08	DP 120 20 03 S08	DP 120 30 03 S08



Sifon Tipi : S08

S08

h : 30/80 mm
Karot ø: 110 mm - Care Drill Diameter ø: 110 mm
Kokusuz / Odor free

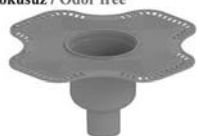

S10

h : 60 mm
Debi: 60 lt/dk - Flow: 60 lt/min
Kokusuz / Odor free



S11

h : 70 mm
Debi: 60 lt/dk - Flow: 60 lt/min
Kokusuz / Odor free



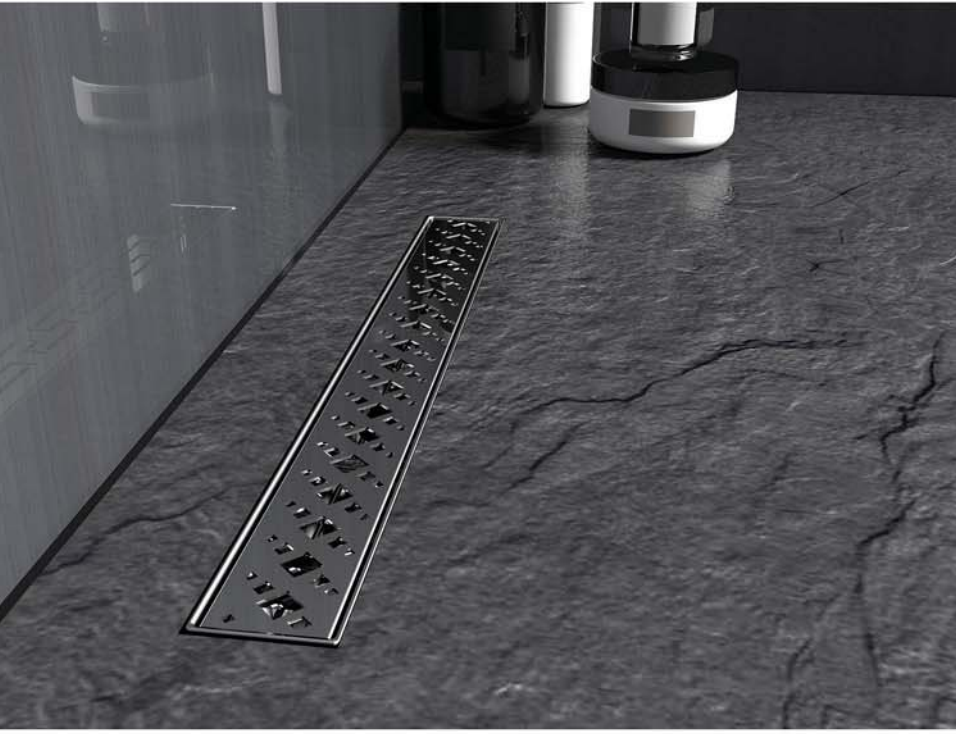

PH DESIGN

Premium serisi ile duş alanlarına modern , estetik ve kullanışlı çözümler sunuyor. Hemzemin uygulama karo ile bütünleşerek engelsiz banyolar yaratıyor. Yeni teknolojiyi kullanarak PATENTLİ CONTASIZ sistem ile sızdırmalıkta standartları yeniden belirliyor.

Premium serisi ürünler;

-Yalıtım bitimli kaynaksız yekpare gövde, şap yüksekliğini için yükseklikayar seti, farklı montaj yükseklikleri ve drenaj kapasiteleri ile projelere uygun alternatif mekanik çözümler sunan, 360 derece dönebilen yüksek drenaj kapasiteli koku fermatürlü S sifon, saç tutucu, 20 cm genişliğinde bütül bant, uygulama sonrası oluşabilecek kot farklılıklarını önleyen yükseklik ayar setini uygulama kolaylığı sağlayacak şekilde standardize ederek Tek parça ürün olarak birleştiriyor ve kullanıcılara kolay montaj avantajı sunuyor.

EBAT Size	Inox Satinox	Inox Ayna Mirror	Altın Ayna Gold	Bakır Ayna Bronze
30 cm	DP 030 01 04 S01 122 \$	DP 030 00 04 S01 141 \$	DP 030 20 04 S01 154 \$	DP 030 30 04 S01 185 \$
40 cm	DP 040 01 04 S01 142 \$	DP 040 00 04 S01 153 \$	DP 040 20 04 S01 166 \$	DP 040 30 04 S01 200 \$
50 cm	DP 050 01 04 S01 156 \$	DP 050 00 04 S01 169 \$	DP 050 20 04 S01 183 \$	DP 050 30 04 S01 220 \$
60 cm	DP 060 01 04 S01 183 \$	DP 060 00 04 S01 196 \$	DP 060 20 04 S01 209 \$	DP 060 30 04 S01 251 \$
70 cm	DP 070 01 04 S01 200 \$	DP 070 00 04 S01 223 \$	DP 070 20 04 S01 233 \$	DP 070 30 04 S01 280 \$
80 cm	DP 080 01 04 S01 219 \$	DP 080 00 04 S01 233 \$	DP 080 20 04 S01 249 \$	DP 080 30 04 S01 299 \$
90 cm	DP 090 01 04 S01 249 \$	DP 090 00 04 S01 275 \$	DP 090 20 04 S01 287 \$	DP 090 30 04 S01 344 \$
100 cm	DP 100 01 04 S01 272 \$	DP 100 00 04 S01 297 \$	DP 100 20 04 S01 311 \$	DP 100 30 04 S01 373 \$
120 cm	DP 120 01 04 S01 311 \$	DP 120 00 04 S01 338 \$	DP 120 20 04 S01 351 \$	DP 120 30 04 S01 421 \$



Sifon Tipi : S01

EBAT Size	Inox Satinox	Inox Ayna Mirror	Altın Ayna Gold	Bakır Ayna Bronze
30 cm	DP 030 01 04 S02 122 \$	DP 030 00 04 S02 141 \$	DP 030 20 04 S02 154 \$	DP 030 30 04 S02 185 \$
40 cm	DP 040 01 04 S02 142 \$	DP 040 00 04 S02 153 \$	DP 040 20 04 S02 166 \$	DP 040 30 04 S02 200 \$
50 cm	DP 050 01 04 S02 156 \$	DP 050 00 04 S02 169 \$	DP 050 20 04 S02 183 \$	DP 050 30 04 S02 220 \$
60 cm	DP 060 01 04 S02 183 \$	DP 060 00 04 S02 196 \$	DP 060 20 04 S02 209 \$	DP 060 30 04 S02 251 \$
70 cm	DP 070 01 04 S02 200 \$	DP 070 00 04 S02 223 \$	DP 070 20 04 S02 233 \$	DP 070 30 04 S02 280 \$
80 cm	DP 080 01 04 S02 219 \$	DP 080 00 04 S02 233 \$	DP 080 20 04 S02 249 \$	DP 080 30 04 S02 299 \$
90 cm	DP 090 01 04 S02 249 \$	DP 090 00 04 S02 275 \$	DP 090 20 04 S02 287 \$	DP 090 30 04 S02 344 \$
100 cm	DP 100 01 04 S02 272 \$	DP 100 00 04 S02 297 \$	DP 100 20 04 S02 311 \$	DP 100 30 04 S02 373 \$
120 cm	DP 120 01 04 S02 311 \$	DP 120 00 04 S02 338 \$	DP 120 20 04 S02 351 \$	DP 120 30 04 S02 421 \$



Sifon Tipi : S02

S01

h : 60 mm
Debi: 51 lt/dk - Flow: 51 lt/min
Kokusuz / Odor free



S02

h : 70 mm
Debi: 48 lt/dk - Flow: 48 lt/min
Kokusuz / Odor free



S03

h : 30/80 mm
Karot ø: 120mm -Care Drill Diameter ø: 120mm
Kokusuz / Odor free



EBAT Size	Inox Satinox	Inox Ayna Mirror	Altın Ayna Gold	Bakır Ayna Bronze
30 cm	DP 030 01 04 S10 137 \$	DP 030 00 04 S10 156 \$	DP 030 20 04 S10 169 \$	DP 030 30 04 S10 203 \$
40 cm	DP 040 01 04 S10 157 \$	DP 040 00 04 S10 168 \$	DP 040 20 04 S10 181 \$	DP 040 30 04 S10 217 \$
50 cm	DP 050 01 04 S10 171 \$	DP 050 00 04 S10 184 \$	DP 050 20 04 S10 198 \$	DP 050 30 04 S10 238 \$
60 cm	DP 060 01 04 S10 198 \$	DP 060 00 04 S10 211 \$	DP 060 20 04 S10 224 \$	DP 060 30 04 S10 269 \$
70 cm	DP 070 01 04 S10 215 \$	DP 070 00 04 S10 238 \$	DP 070 20 04 S10 248 \$	DP 070 30 04 S10 298 \$
80 cm	DP 080 01 04 S10 234 \$	DP 080 00 04 S10 248 \$	DP 080 20 04 S10 264 \$	DP 080 30 04 S10 317 \$
90 cm	DP 090 01 04 S10 264 \$	DP 090 00 04 S10 290 \$	DP 090 20 04 S10 302 \$	DP 090 30 04 S10 362 \$
100 cm	DP 100 01 04 S10 287 \$	DP 100 00 04 S10 312 \$	DP 100 20 04 S10 326 \$	DP 100 30 04 S10 391 \$
120 cm	DP 120 01 04 S10 326 \$	DP 120 00 04 S10 353 \$	DP 120 20 04 S10 366 \$	DP 120 30 04 S10 439 \$



Sifon Tipi : S10

EBAT Size	Inox Satinox	Inox Ayna Mirror	Altın Ayna Gold	Bakır Ayna Bronze
30 cm	DP 030 01 04 S11 137 \$	DP 030 00 04 S11 156 \$	DP 030 20 04 S11 169 \$	DP 030 30 04 S11 203 \$
40 cm	DP 040 01 04 S11 157 \$	DP 040 00 04 S11 168 \$	DP 040 20 04 S11 181 \$	DP 040 30 04 S11 217 \$
50 cm	DP 050 01 04 S11 171 \$	DP 050 00 04 S11 184 \$	DP 050 20 04 S11 198 \$	DP 050 30 04 S11 238 \$
60 cm	DP 060 01 04 S11 198 \$	DP 060 00 04 S11 211 \$	DP 060 20 04 S11 224 \$	DP 060 30 04 S11 269 \$
70 cm	DP 070 01 04 S11 215 \$	DP 070 00 04 S11 238 \$	DP 070 20 04 S11 248 \$	DP 070 30 04 S11 298 \$
80 cm	DP 080 01 04 S11 234 \$	DP 080 00 04 S11 248 \$	DP 080 20 04 S11 264 \$	DP 080 30 04 S11 317 \$
90 cm	DP 090 01 04 S11 264 \$	DP 090 00 04 S11 290 \$	DP 090 20 04 S11 302 \$	DP 090 30 04 S11 362 \$
100 cm	DP 100 01 04 S11 287 \$	DP 100 00 04 S11 312 \$	DP 100 20 04 S11 326 \$	DP 100 30 04 S11 391 \$
120 cm	DP 120 01 04 S11 326 \$	DP 120 00 04 S11 353 \$	DP 120 20 04 S11 366 \$	DP 120 30 04 S11 439 \$



Sifon Tipi : S11

EBAT Size	Inox Satinox	Inox Ayna Mirror	Altın Ayna Gold	Bakır Ayna Bronze
30 cm	DP 030 01 04 S03 122 \$	DP 030 00 04 S03 141 \$	DP 030 20 04 S03 154 \$	DP 030 30 04 S03 185 \$
40 cm	DP 040 01 04 S03 142 \$	DP 040 00 04 S03 153 \$	DP 040 20 04 S03 166 \$	DP 040 30 04 S03 200 \$
50 cm	DP 050 01 04 S03 156 \$	DP 050 00 04 S03 169 \$	DP 050 20 04 S03 183 \$	DP 050 30 04 S03 220 \$
60 cm	DP 060 01 04 S03 183 \$	DP 060 00 04 S03 196 \$	DP 060 20 04 S03 209 \$	DP 060 30 04 S03 251 \$
70 cm	DP 070 01 04 S03 200 \$	DP 070 00 04 S03 223 \$	DP 070 20 04 S03 233 \$	DP 070 30 04 S03 280 \$
80 cm	DP 080 01 04 S03 219 \$	DP 080 00 04 S03 233 \$	DP 080 20 04 S03 249 \$	DP 080 30 04 S03 298 \$
90 cm	DP 090 01 04 S03 249 \$	DP 090 00 04 S03 275 \$	DP 090 20 04 S03 287 \$	DP 090 30 04 S03 344 \$
100 cm	DP 100 01 04 S03 272 \$	DP 100 00 04 S03 297 \$	DP 100 20 04 S03 311 \$	DP 100 30 04 S03 373 \$
120 cm	DP 120 01 04 S03 311 \$	DP 120 00 04 S03 338 \$	DP 120 20 04 S03 351 \$	DP 120 30 04 S03 421 \$



Sifon Tipi : S03

EBAT Size	Inox Satinox	Inox Ayna Mirror	Altın Ayna Gold	Bakır Ayna Bronze
30 cm	DP 030 01 04 S08 157 \$	DP 030 00 04 S08 176 \$	DP 030 20 04 S08 189 \$	DP 030 30 04 S08 227 \$
40 cm	DP 040 01 04 S08 177 \$	DP 040 00 04 S08 188 \$	DP 040 20 04 S08 201 \$	DP 040 30 04 S08 241 \$
50 cm	DP 050 01 04 S08 191 \$	DP 050 00 04 S08 204 \$	DP 050 20 04 S08 218 \$	DP 050 30 04 S08 262 \$
60 cm	DP 060 01 04 S08 218 \$	DP 060 00 04 S08 231 \$	DP 060 20 04 S08 244 \$	DP 060 30 04 S08 293 \$
70 cm	DP 070 01 04 S08 235 \$	DP 070 00 04 S08 258 \$	DP 070 20 04 S08 268 \$	DP 070 30 04 S08 322 \$
80 cm	DP 080 01 04 S08 254 \$	DP 080 00 04 S08 268 \$	DP 080 20 04 S08 284 \$	DP 080 30 04 S08 341 \$
90 cm	DP 090 01 04 S08 284 \$	DP 090 00 04 S08 310 \$	DP 090 20 04 S08 322 \$	DP 090 30 04 S08 386 \$
100 cm	DP 100 01 04 S08 307 \$	DP 100 00 04 S08 332 \$	DP 100 20 04 S08 346 \$	DP 100 30 04 S08 415 \$
120 cm	DP 120 01 04 S08 346 \$	DP 120 00 04 S08 373 \$	DP 120 20 04 S08 386 \$	DP 120 30 04 S08 463 \$



Sifon Tipi : S08

S08

h : 30/80 mm
Karat ø: 110 mm - Care Drill Diameter ø: 110 mm
Kokusuz / Odor free



S10

h : 60 mm
Debi: 60 lt/dk - Flow: 60 lt/min
Kokusuz / Odor free



S11

h : 70 mm
Debi: 60 lt/dk - Flow: 60 lt/min
Kokusuz / Odor free



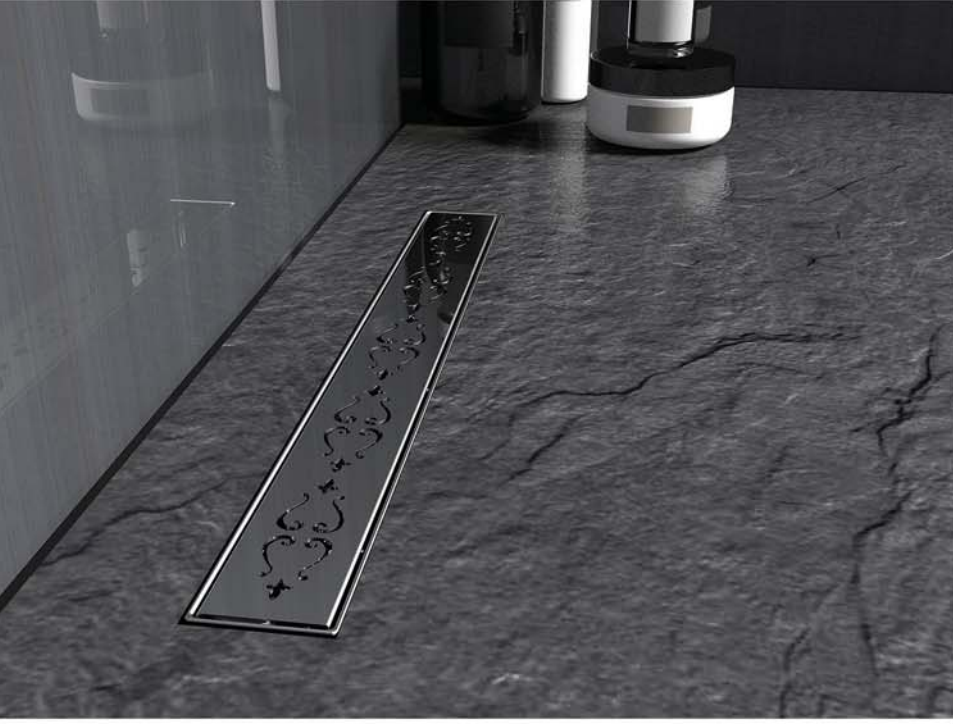

PH DESIGN

Premium serisi ile duş alanlarına modern , estetik ve kullanışlı çözümler sunuyor. Hemzemin uygulama karo ile bütünleşerek engelsiz banyolar yaratıyor. Yeni teknolojiyi kullanarak PATENTLİ CONTASIZ sistem ile sızdırmalıkta standartları yeniden belirliyor.

Premium serisi ürünler;

-Yalıtım bitimli kaynaksız yekpare gövde, şap yüksekliğini için yükseklikayar seti, farklı montaj yükseklikleri ve drenaj kapasiteleri ile projelere uygun alternatif mekanik çözümler sunan, 360 derece dönebilen yüksek drenaj kapasiteli koku fermatürlü S sifon, saç tutucu, 20 cm genişliğinde bütül bant, uygulama sonrası oluşabilecek kot farklılıklarını önleyen yükseklik ayar setini uygulama kolaylığı sağlayacak şekilde standardize ederek Tek parça ürün olarak birleştiriyor ve kullanıcılara kolay montaj avantajı sunuyor.

EBAT Size	Inox Satinox	Inox Ayna Mirror	Altın Ayna Gold	Bakır Ayna Bronze
30 cm	DP 030 01 05 S01 122 \$	DP 030 00 05 S01 141 \$	DP 030 20 05 S01 154 \$	DP 030 30 05 S01 185 \$
40 cm	DP 040 01 05 S01 142 \$	DP 040 00 05 S01 153 \$	DP 040 20 05 S01 166 \$	DP 040 30 05 S01 199 \$
50 cm	DP 050 01 05 S01 156 \$	DP 050 00 05 S01 169 \$	DP 050 20 05 S01 183 \$	DP 050 30 05 S01 220 \$
60 cm	DP 060 01 05 S01 183 \$	DP 060 00 05 S01 196 \$	DP 060 20 05 S01 209 \$	DP 060 30 05 S01 251 \$
70 cm	DP 070 01 05 S01 200 \$	DP 070 00 05 S01 223 \$	DP 070 20 05 S01 233 \$	DP 070 30 05 S01 280 \$
80 cm	DP 080 01 05 S01 219 \$	DP 080 00 05 S01 233 \$	DP 080 20 05 S01 249 \$	DP 080 30 05 S01 299 \$
90 cm	DP 090 01 05 S01 249 \$	DP 090 00 05 S01 275 \$	DP 090 20 05 S01 287 \$	DP 090 30 05 S01 344 \$
100 cm	DP 100 01 05 S01 272 \$	DP 100 00 05 S01 297 \$	DP 100 20 05 S01 311 \$	DP 100 30 05 S01 373 \$
120 cm	DP 120 01 05 S01 311 \$	DP 120 00 05 S01 338 \$	DP 120 20 05 S01 351 \$	DP 120 30 05 S01 421 \$



Sifon Tipi : S01

EBAT Size	Inox Satinox	Inox Ayna Mirror	Altın Ayna Gold	Bakır Ayna Bronze
30 cm	DP 030 01 05 S02 122 \$	DP 030 00 05 S02 141 \$	DP 030 20 05 S02 154 \$	DP 030 30 05 S02 185 \$
40 cm	DP 040 01 05 S02 142 \$	DP 040 00 05 S02 153 \$	DP 040 20 05 S02 166 \$	DP 040 30 05 S02 199 \$
50 cm	DP 050 01 05 S02 156 \$	DP 050 00 05 S02 169 \$	DP 050 20 05 S02 183 \$	DP 050 30 05 S02 220 \$
60 cm	DP 060 01 05 S02 183 \$	DP 060 00 05 S02 196 \$	DP 060 20 05 S02 209 \$	DP 060 30 05 S02 251 \$
70 cm	DP 070 01 05 S02 200 \$	DP 070 00 05 S02 223 \$	DP 070 20 05 S02 233 \$	DP 070 30 05 S02 280 \$
80 cm	DP 080 01 05 S02 219 \$	DP 080 00 05 S02 233 \$	DP 080 20 05 S02 249 \$	DP 080 30 05 S02 299 \$
90 cm	DP 090 01 05 S02 249 \$	DP 090 00 05 S02 275 \$	DP 090 20 05 S02 287 \$	DP 090 30 05 S02 344 \$
100 cm	DP 100 01 05 S02 272 \$	DP 100 00 05 S02 297 \$	DP 100 20 05 S02 311 \$	DP 100 30 05 S02 373 \$
120 cm	DP 120 01 05 S02 311 \$	DP 120 00 05 S02 338 \$	DP 120 20 05 S02 351 \$	DP 120 30 05 S02 421 \$



Sifon Tipi : S02

S01

h : 60 mm
Debi: 51 lt/dk - Flow: 51 lt/min
Kokusuz / Odor free



S02

h : 70 mm
Debi: 48 lt/dk - Flow: 48 lt/min
Kokusuz / Odor free



S03

h : 30/80 mm
Karot ø: 120mm -Care Drill Diameter ø: 120mm
Kokusuz / Odor free



EBAT Size	Inox Satinox	Inox Ayna Mirror	Altın Ayna Gold	Bakır Ayna Bronze
30 cm	DP 030 01 05 S10	DP 030 00 05 S10	DP 030 20 05 S10	DP 030 30 05 S10
40 cm	DP 040 01 05 S10	DP 040 00 05 S10	DP 040 20 05 S10	DP 040 30 05 S10
50 cm	DP 050 01 05 S10	DP 050 00 05 S10	DP 050 20 05 S10	DP 050 30 05 S10
60 cm	DP 060 01 05 S10	DP 060 00 05 S10	DP 060 20 05 S10	DP 060 30 05 S10
70 cm	DP 070 01 05 S10	DP 070 00 05 S10	DP 070 20 05 S10	DP 070 30 05 S10
80 cm	DP 080 01 05 S10	DP 080 00 05 S10	DP 080 20 05 S10	DP 080 30 05 S10
90 cm	DP 090 01 05 S10	DP 090 00 05 S10	DP 090 20 05 S10	DP 090 30 05 S10
100 cm	DP 100 01 05 S10	DP 100 00 05 S10	DP 100 20 05 S10	DP 100 30 05 S10
120 cm	DP 120 01 05 S10	DP 120 00 05 S10	DP 120 20 05 S10	DP 120 30 05 S10



Sifon Tipi : S10

EBAT Size	Inox Satinox	Inox Ayna Mirror	Altın Ayna Gold	Bakır Ayna Bronze
30 cm	DP 030 01 05 S11	DP 030 00 05 S11	DP 030 20 05 S11	DP 030 30 05 S11
40 cm	DP 040 01 05 S11	DP 040 00 05 S11	DP 040 20 05 S11	DP 040 30 05 S11
50 cm	DP 050 01 05 S11	DP 050 00 05 S11	DP 050 20 05 S11	DP 050 30 05 S11
60 cm	DP 060 01 05 S11	DP 060 00 05 S11	DP 060 20 05 S11	DP 060 30 05 S11
70 cm	DP 070 01 05 S11	DP 070 00 05 S11	DP 070 20 05 S11	DP 070 30 05 S11
80 cm	DP 080 01 05 S11	DP 080 00 05 S11	DP 080 20 05 S11	DP 080 30 05 S11
90 cm	DP 090 01 05 S11	DP 090 00 05 S11	DP 090 20 05 S11	DP 090 30 05 S11
100 cm	DP 100 01 05 S11	DP 100 00 05 S11	DP 100 20 05 S11	DP 100 30 05 S11
120 cm	DP 120 01 05 S11	DP 120 00 05 S11	DP 120 20 05 S11	DP 120 30 05 S11



Sifon Tipi : S11

EBAT Size	Inox Satinox	Inox Ayna Mirror	Altın Ayna Gold	Bakır Ayna Bronze
30 cm	DP 030 01 05 S03	DP 030 00 05 S03	DP 030 20 05 S03	DP 030 30 05 S03
40 cm	DP 040 01 05 S03	DP 040 00 05 S03	DP 040 20 05 S03	DP 040 30 05 S03
50 cm	DP 050 01 05 S03	DP 050 00 05 S03	DP 050 20 05 S03	DP 050 30 05 S03
60 cm	DP 060 01 05 S03	DP 060 00 05 S03	DP 060 20 05 S03	DP 060 30 05 S03
70 cm	DP 070 01 05 S03	DP 070 00 05 S03	DP 070 20 05 S03	DP 070 30 05 S03
80 cm	DP 080 01 05 S03	DP 080 00 05 S03	DP 080 20 05 S03	DP 080 30 05 S03
90 cm	DP 090 01 05 S03	DP 090 00 05 S03	DP 090 20 05 S03	DP 090 30 05 S03
100 cm	DP 100 01 05 S03	DP 100 00 05 S03	DP 100 20 05 S03	DP 100 30 05 S03
120 cm	DP 120 01 05 S03	DP 120 00 05 S03	DP 120 20 05 S03	DP 120 30 05 S03



Sifon Tipi : S03

EBAT Size	Inox Satinox	Inox Ayna Mirror	Altın Ayna Gold	Bakır Ayna Bronze
30 cm	DP 030 01 05 S08	DP 030 00 05 S08	DP 030 20 05 S08	DP 030 30 05 S08
40 cm	DP 040 01 05 S08	DP 040 00 05 S08	DP 040 20 05 S08	DP 040 30 05 S08
50 cm	DP 050 01 05 S08	DP 050 00 05 S08	DP 050 20 05 S08	DP 050 30 05 S08
60 cm	DP 060 01 05 S08	DP 060 00 05 S08	DP 060 20 05 S08	DP 060 30 05 S08
70 cm	DP 070 01 05 S08	DP 070 00 05 S08	DP 070 20 05 S08	DP 070 30 05 S08
80 cm	DP 080 01 05 S08	DP 080 00 05 S08	DP 080 20 05 S08	DP 080 30 05 S08
90 cm	DP 090 01 05 S08	DP 090 00 05 S08	DP 090 20 05 S08	DP 090 30 05 S08
100 cm	DP 100 01 05 S08	DP 100 00 05 S08	DP 100 20 05 S08	DP 100 30 05 S08
120 cm	DP 120 01 05 S08	DP 120 00 05 S08	DP 120 20 05 S08	DP 120 30 05 S08



Sifon Tipi : S08

S08

h : 30/80 mm
Karot ø: 110 mm - Care Drill Diameter ø: 110 mm
Kokusuz / Odor free



S10







h : 60 mm
Debi: 60 lt/dk - Flow: 60 lt/min
Kokusuz / Odor free



S11

h : 70 mm
Debi: 60 lt/dk - Flow: 60 lt/min
Kokusuz / Odor free



 odor prevent system			
5l/min 			
304 stainles steel	 + easy to clean		
 360° base rotation	 60 mm	Ø 50 output	 easy assembling

Duř kanallarında PH Prodrain... Ürünün görsel zerafetiyle banyo ayrı bir keyif... PH Prodrain serisi 5.5 cm yüzey genişliđi sunan son teknoloji üretim ile ıslak mekanlara yepyeni tasarım seçenekleri sunuyor. PH Prodrain yüzey genişliđi [5.5cm] slim sifon yüksekliđi [7cm]'ne sahip olan PH Prodrain aynı zamanda 3 farklı dekoratif renklerde üretilen ızgara çerçevesi ve tüm seramik yüzeyler ile mükemmel kombinasyon sağlıyor. Sahip olduđu yalıtım eteđi ile drenaj için mükemmel bir çözüm sunuyor. 360 derece döner sifon ile kolay montaj sağlıyor.En önemli özelliklerinden biri de ızgara çerçevesi, yükseklik ayar seti ve süzgecin aynı parçada tasarım olarak sunulması.



PH PRODRAIN

PH Prodrain design in shower channels... With the visual elegance of product, bathrooms offer a unique pleasure... PH Prodrain shower channel with its state of the art production that provides 5.5 cm surface width, PH Slim Series offer brand new design options for wet surfaces. With its grill frame produced in 3 different decorative colours, PH Prodrain, which has a surface width of [5.5cm] and flusher height of [5cm], stainless steel weldless single piece body, makes perfect combinations with all tile surfaces. It offers easy assembly, thanks to its 360 degree rotating flusher. One of its most important characteristics is the offering of the grill frame, height adjustment kit and the drainer within the same part as part of the design.

Uygulama Kesit :

1. Döşeme Betonunu / Covering Concrete
2. Tesviye Betonunu / Levelling Concrete
3. Ph Dizayn Butil Bant / ph design Butil Bant
4. İzolasyon Katmanı / İnsulation Layer
5. Yapıştırıcı / Adhesive
6. Kaplama Malzemesi / Covering

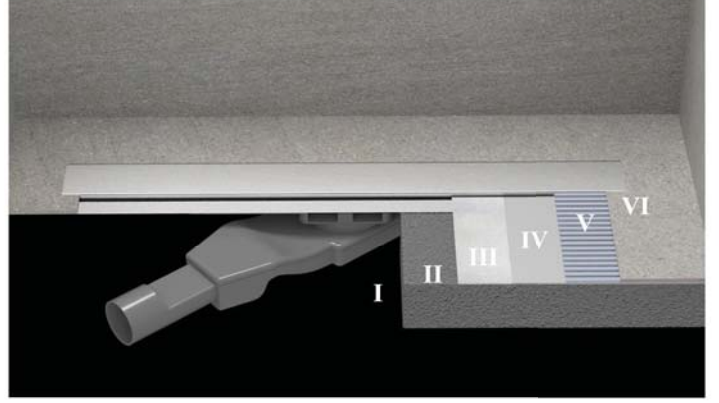

Sifon Tipi : S01

Kapak (1.5 mm kalınlık) / Top cover (1.5 mm)

Yükseklik Ayar Vidası / Height Adjustment Screw

Saç Tutucu Süzgeç / Hair Holder

Yalıtım Etekli Ana Gövde / Insulated Main Body

Patentli Contasız Bağlantı Parçası / Patented Without Gasket Part

360° Döner Sifon S01 / 360° Degree Rotating Flusher

Yükseklik Ayar Parçası / Height Adjustment Kit

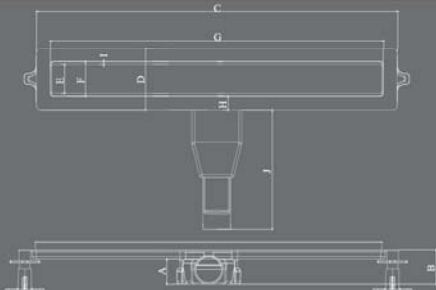

	30	40	50	60	70	80	90
A	4.3	4.3	4.3	4.3	4.3	4.3	4.3
B	6	6	6	6	6	6	6
C	35	45	55	65	75	85	95
D	11.3	11.3	11.3	11.3	11.3	11.3	11.3
E	5.2	5.2	5.2	5.2	5.2	5.2	5.2
F	6.3	6.3	6.3	6.3	6.3	6.3	6.3
G	30	40	50	60	70	80	90
H	2.5	2.5	2.5	2.5	2.5	2.5	2.5
I	5	5	5	5	5	5	5
J	21.3	21.3	21.3	21.3	21.3	21.3	21.3



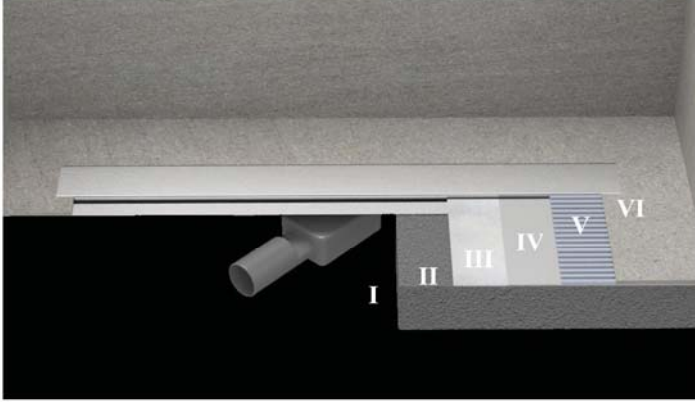

Uygulama Kesit :

1. Döşeme Betonu / Covering Concrete
2. Tesviye Betonu / Levelling Concrete
3. Ph Dizayn Butil Bant / ph design Butil Bant
4. İzolasyon Katmanı / Insulation Layer
5. Yapıştırıcı / Adhesive
6. Kaplama Malzemesi / Covering

Sifon Tipi : S02

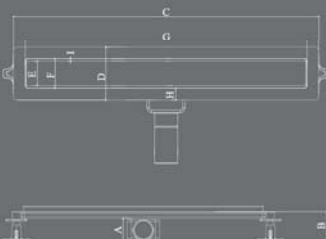
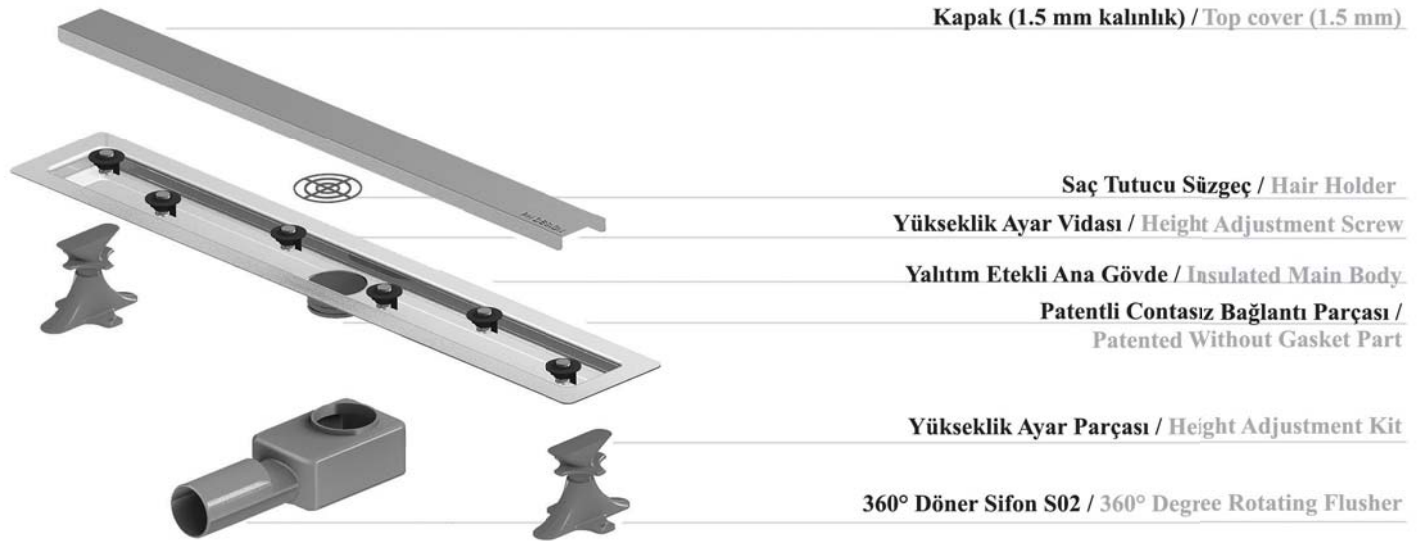

	30	40	50	60	70	80	90
A	5	5	5	5	5	5	5
B	7	7	7	7	7	7	7
C	35	45	55	65	75	85	95
D	11.3	11.3	11.3	11.3	11.3	11.3	11.3
E	5.2	5.2	5.2	5.2	5.2	5.2	5.2
F	6.3	6.3	6.3	6.3	6.3	6.3	6.3
G	30	40	50	60	70	80	90
H	2.5	2.5	2.5	2.5	2.5	2.5	2.5
I	5	5	5	5	5	5	5
J	13.5	13.5	13.5	13.5	13.5	13.5	13.5

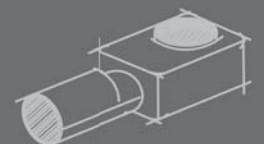

Uygulama Kesit :

1. Döşeme Betonu / Covering Concrete
2. Tesviye Betonu / Levelling Concrete
3. Ph Dizayn Butil Bant / ph design Butil Bant
4. İzolasyon Katmanı / Insulation Layer
5. Yapıştırıcı / Adhesive
6. Kaplama Malzemesi / Covering

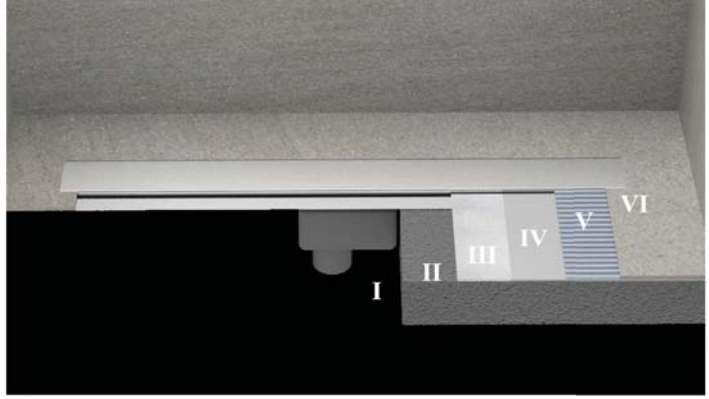

Sifon Tipi : S03

Kapak (1.5 mm kalınlık) / Top cover (1.5 mm)

Yükseklik Ayar Vidası / Height Adjustment Screw

Saç Tutucu Süzgeç / Hair Holder

Yalıtım Etekli Ana Gövde / Insulated Main Body

Patentli Contasız Bağlantı Parçası / Patented Without Gasket Part

360° Döner Sifon S03 / 360° Degree Rotating Flusher

Yükseklik Ayar Parçası / Height Adjustment Kit

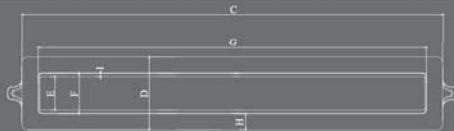
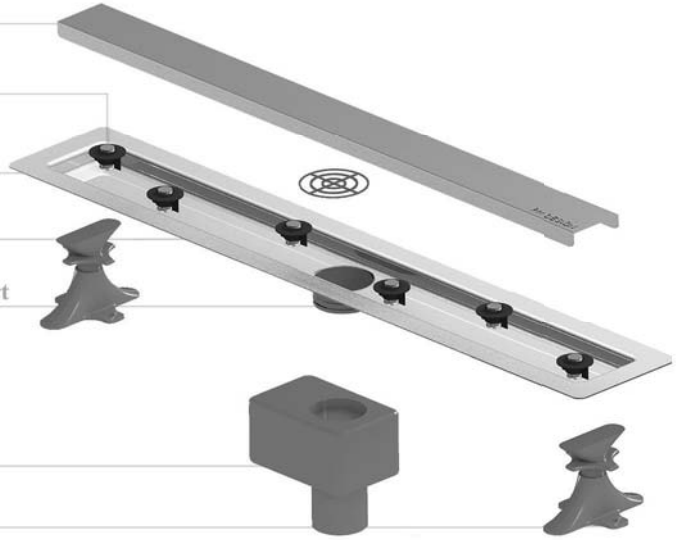

	30	40	50	60	70	80	90
A	11	11	11	11	11	11	11
B	12.6	12.6	12.6	12.6	12.6	12.6	12.6
C	35	45	55	65	75	85	95
D	11.3	11.3	11.3	11.3	11.3	11.3	11.3
E	5.2	5.2	5.2	5.2	5.2	5.2	5.2
F	6.3	6.3	6.3	6.3	6.3	6.3	6.3
G	30	40	50	60	70	80	90
H	2.5	2.5	2.5	2.5	2.5	2.5	2.5
I	5	5	5	5	5	5	5



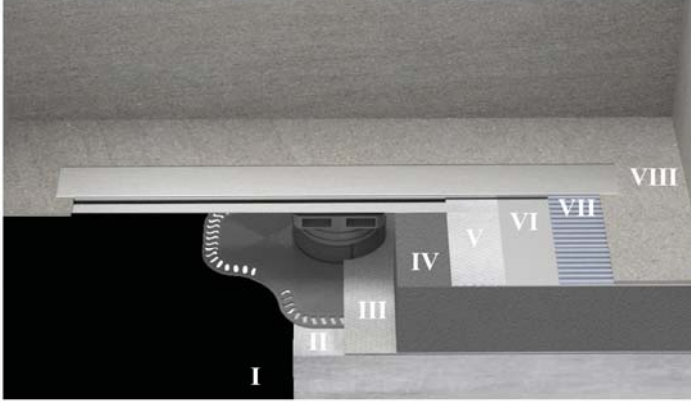

Uygulama Kesit :

1. Beton Katmanı / Concrete Layer
2. İzolasyon Katmanı / Insulation Layer
3. Döşeme Betonu / Covering Concrete
4. Tesviye Betonu / Levelling Concrete
5. Ph Dizayn Butil Bant / ph design Butil Bant
6. İzolasyon Katmanı / Insulation Layer
7. Yapıştırıcı / Adhesive
8. Kaplama Malzemesi / Covering

Sifon Tipi : S08



Kapak (1.5 mm kalınlık) / Top cover (1.5 mm)

Yükseklik Ayar Vidası / Height Adjustment Screw

Saç Tutucu Süzgeç / Hair Holder

Yalıtım Etekli Ana Gövde / Insulated Main Body

Patentli Contasız Bağlantı Parçası /
Patented Without Gasket Part

Tesviye Betonu Yükseklik Ayar Parçası /
Height Adjustment Part For Levelling Concrete

Yükseklik Ayar Parçası / Height Adjustment Kit

360° Döner Sifon S08 / 360° Degree Rotating Flusher

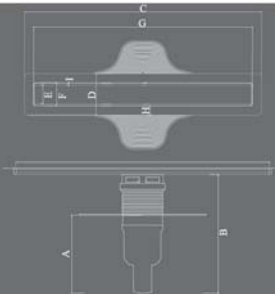

	30	40	50	60	70	80	90
A	16	16	16	16	16	16	16
B	AYARLANABİLİR	AYARLANABİLİR	AYARLANABİLİR	AYARLANABİLİR	AYARLANABİLİR	AYARLANABİLİR	AYARLANABİLİR
C	35	45	55	65	75	85	95
D	11.3	11.3	11.3	11.3	11.3	11.3	11.3
E	4.5	4.5	4.5	4.5	4.5	4.5	4.5
F	5.2	5.2	5.2	5.2	5.2	5.2	5.2
G	30	40	50	60	70	80	90
H	2.5	2.5	2.5	2.5	2.5	2.5	2.5
I	5	5	5	5	5	5	5
J	9.4	9.4	9.4	9.4	9.4	9.4	9.4

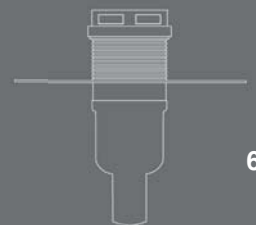

Uygulama Kesit :

1. Döşeme Betonu / Covering Concrete
2. Tesviye Betonu / Levelling Concrete
3. Ph Dizayn Butil Bant / ph design Butil Bant
4. İzolasyon Katmanı / Insulation Layer
5. Yapıştırıcı / Adhesive
6. Kaplama Malzemesi / Covering

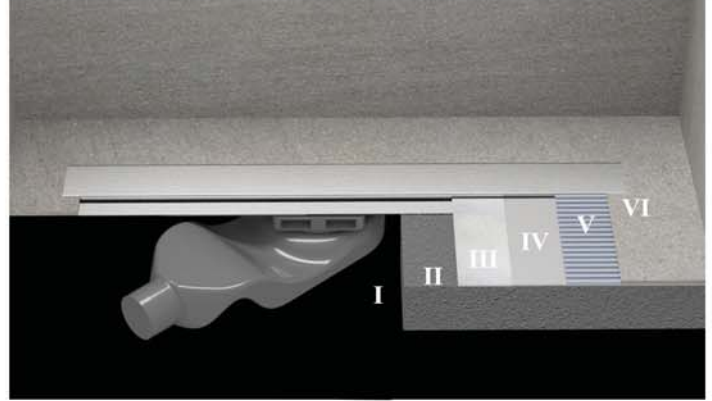

Sifon Tipi : S10

Kapak (1.5 mm kalınlık) / Top cover (1.5 mm)

Yükseklik Ayar Vidası / Height Adjustment Screw

Saç Tutucu Süzgeç / Hair Holder

Yalıtım Etekli Ana Gövde / Insulated Main Body

Patentli Contasız Bağlantı Parçası / Patented Without Gasket Part

360° Döner Sifon S10 / 360° Degree Rotating Flusher

Yükseklik Ayar Parçası / Height Adjustment Kit

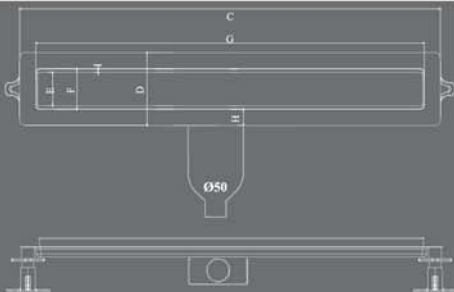

	30	40	50	60	70	80	90
A	4.3	4.3	4.3	4.3	4.3	4.3	4.3
B	6	6	6	6	6	6	6
C	35	45	55	65	75	85	95
D	11.3	11.3	11.3	11.3	11.3	11.3	11.3
E	5.2	5.2	5.2	5.2	5.2	5.2	5.2
F	6.3	6.3	6.3	6.3	6.3	6.3	6.3
G	30	40	50	60	70	80	90
H	2.5	2.5	2.5	2.5	2.5	2.5	2.5
I	5	5	5	5	5	5	5
J	21.3	21.3	21.3	21.3	21.3	21.3	21.3



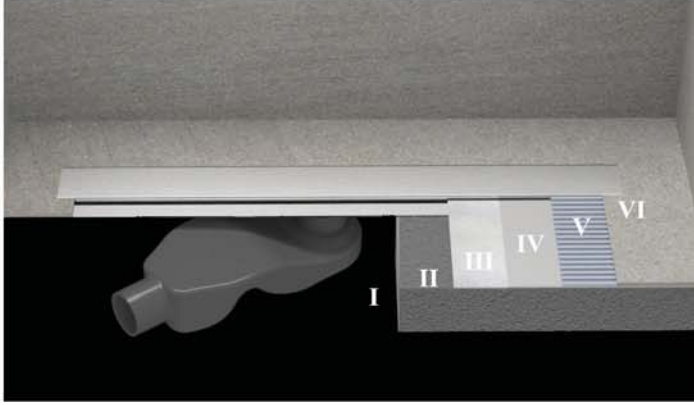

Uygulama Kesit :

1. Döşeme Betonu / Covering Concrete
2. Tesviye Betonu / Levelling Concrete
3. Ph Dizayn Butil Bant / ph design Butil Bant
4. İzolasyon Katmanı / Insulation Layer
5. Yapıştırıcı / Adhesive
6. Kaplama Malzemesi / Covering

Sifon Tipi : S11

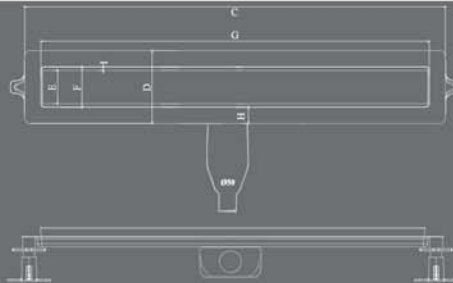
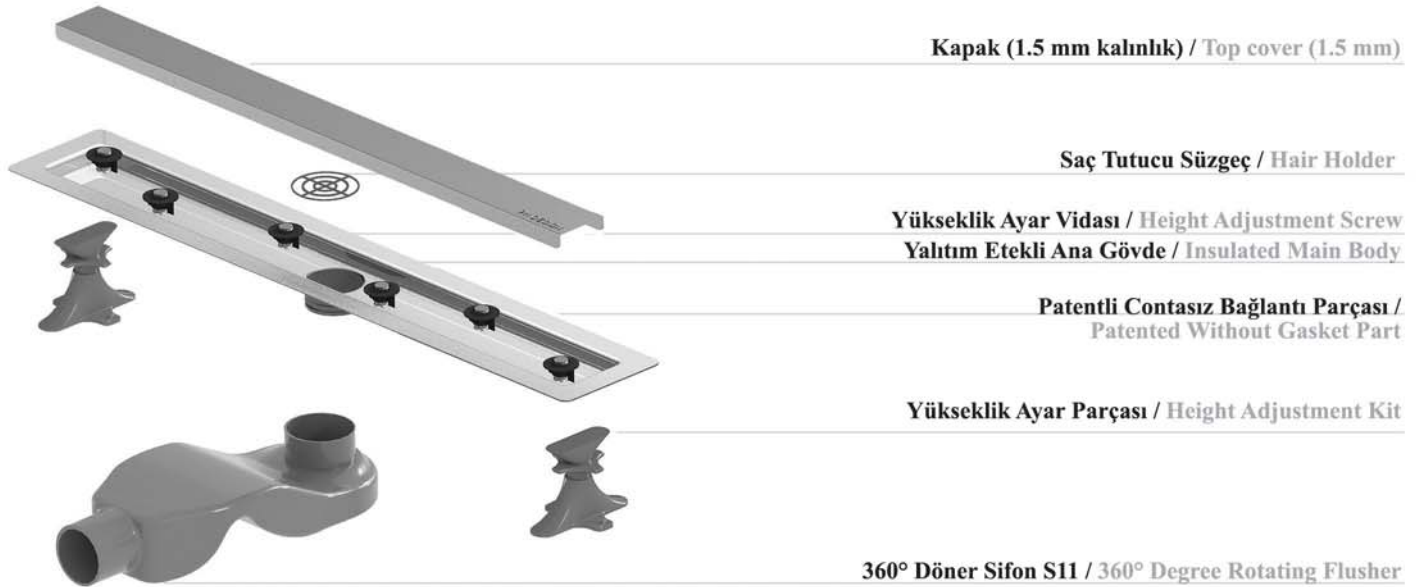

	30	40	50	60	70	80	90
A	5	5	5	5	5	5	5
B	7	7	7	7	7	7	7
C	35	45	55	65	75	85	95
D	11.3	11.3	11.3	11.3	11.3	11.3	11.3
E	5.2	5.2	5.2	5.2	5.2	5.2	5.2
F	6.3	6.3	6.3	6.3	6.3	6.3	6.3
G	30	40	50	60	70	80	90
H	2.5	2.5	2.5	2.5	2.5	2.5	2.5
I	5	5	5	5	5	5	5
J	13.5	13.5	13.5	13.5	13.5	13.5	13.5

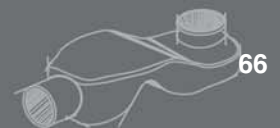



PH DESIGN

Prodrain serisi ile duş alanlarına modern , estetik ve kullanışlı çözümler sunuyor. Hemzemin uygulama karo ile bütünleşerek engelsiz banyolar yaratıyor. Yeni teknolojiyi kullanarak PATENTLİ CONTASIZ sistem ile sızdırmalıkta standartları yeniden belirliyor.

Prodrain serisi ürünler;

-Yalıtım bitimli kaynaksız yekpare gövde, şap yüksekliğini için yükseklikayar seti, farklı montaj yükseklikleri ve drenaj kapasiteleri ile projelere uygun alternatif mekanik çözümler sunan, 360 derece dönebilen yüksek drenaj kapasiteli koku fermatürlü S sifon, saç tutucu, 20 cm genişliğinde bütül bant, uygulama sonrası oluşabilecek kot farklılıklarını önleyen yükseklik ayar setini uygulama kolaylığı sağlayacak şekilde standardize ederek Tek parça ürün olarak birleştiriyor ve kullanıcılara kolay montaj avantajı sunuyor.

EBAT Size	Inox Satinox	Inox Ayna Mirror	Altın Ayna Gold
30 cm	DD 030 01 00 S01 84 \$	DD 030 00 00 S01 95 \$	DD 030 20 00 S01 105 \$
40 cm	DD 040 01 00 S01 95 \$	DD 040 00 00 S01 105 \$	DD 040 20 00 S01 115 \$
50 cm	DD 050 01 00 S01 105 \$	DD 050 00 00 S01 120 \$	DD 050 20 00 S01 135 \$
60 cm	DD 060 01 00 S01 116 \$	DD 060 00 00 S01 140 \$	DD 060 20 00 S01 155 \$
70 cm	DD 070 01 00 S01 127 \$	DD 070 00 00 S01 155 \$	DD 070 20 00 S01 175 \$
80 cm	DD 080 01 00 S01 138 \$	DD 080 00 00 S01 170 \$	DD 080 20 00 S01 185 \$
90 cm	DD 090 01 00 S01 150 \$	DD 090 00 00 S01 205 \$	DD 090 20 00 S01 225 \$



Sifon Tipi : S01

EBAT Size	Inox Satinox	Inox Ayna Mirror	Altın Ayna Gold
30 cm	DD 030 01 00 S02 75 \$	DD 030 00 00 S02 95 \$	DD 030 20 00 S02 105 \$
40 cm	DD 040 01 00 S02 85 \$	DD 040 00 00 S02 105 \$	DD 040 20 00 S02 115 \$
50 cm	DD 050 01 00 S02 95 \$	DD 050 00 00 S02 120 \$	DD 050 20 00 S02 135 \$
60 cm	DD 060 01 00 S02 110 \$	DD 060 00 00 S02 140 \$	DD 060 20 00 S02 155 \$
70 cm	DD 070 01 00 S02 125 \$	DD 070 00 00 S02 155 \$	DD 070 20 00 S02 175 \$
80 cm	DD 080 01 00 S02 135 \$	DD 080 00 00 S02 170 \$	DD 080 20 00 S02 185 \$
90 cm	DD 090 01 00 S02 165 \$	DD 090 00 00 S02 205 \$	DD 090 20 00 S02 225 \$



Sifon Tipi : S02

S01

h : 60 mm
Debi: 51 lt/dk - Flow: 51 lt/min
Kokusuz / Odor free



S02

h : 70 mm
Debi: 48 lt/dk - Flow: 48 lt/min
Kokusuz / Odor free



S03

h : 30/80 mm
Karot ø: 120mm -Core Drill Diameter ø: 120mm
Kokusuz / Odor free



EBAT Size	Inox Satinox		Inox Ayna Mirror		Altın Ayna Gold	
30 cm	DD 030 01 00 S10	90 \$	DD 030 00 00 S10	110 \$	DD 030 20 00 S10	120 \$
40 cm	DD 040 01 00 S10	100 \$	DD 040 00 00 S10	120 \$	DD 040 20 00 S10	130 \$
50 cm	DD 050 01 00 S10	110 \$	DD 050 00 00 S10	135 \$	DD 050 20 00 S10	150 \$
60 cm	DD 060 01 00 S10	125 \$	DD 060 00 00 S10	155 \$	DD 060 20 00 S10	170 \$
70 cm	DD 070 01 00 S10	140 \$	DD 070 00 00 S10	170 \$	DD 070 20 00 S10	190 \$
80 cm	DD 080 01 00 S10	150 \$	DD 080 00 00 S10	185 \$	DD 080 20 00 S10	200 \$
90 cm	DD 090 01 00 S10	185 \$	DD 090 00 00 S10	220 \$	DD 090 20 00 S10	240 \$



Sifon Tipi : S10

EBAT Size	Inox Satinox		Inox Ayna Mirror		Altın Ayna Gold	
30 cm	DD 030 01 00 S11	90 \$	DD 030 00 00 S11	110 \$	DD 030 20 00 S11	120 \$
40 cm	DD 040 01 00 S11	100 \$	DD 040 00 00 S11	120 \$	DD 040 20 00 S11	130 \$
50 cm	DD 050 01 00 S11	110 \$	DD 050 00 00 S11	135 \$	DD 050 20 00 S11	150 \$
60 cm	DD 060 01 00 S11	125 \$	DD 060 00 00 S11	155 \$	DD 060 20 00 S11	170 \$
70 cm	DD 070 01 00 S11	140 \$	DD 070 00 00 S11	170 \$	DD 070 20 00 S11	190 \$
80 cm	DD 080 01 00 S11	150 \$	DD 080 00 00 S11	185 \$	DD 080 20 00 S11	200 \$
90 cm	DD 090 01 00 S11	185 \$	DD 090 00 00 S11	220 \$	DD 090 20 00 S11	240 \$



Sifon Tipi : S11

EBAT Size	Inox Satinox		Inox Ayna Mirror		Altın Ayna Gold	
30 cm	DD 030 01 00 S03	75 \$	DD 030 00 00 S03	95 \$	DD 030 20 00 S03	105 \$
40 cm	DD 040 01 00 S03	85 \$	DD 040 00 00 S03	105 \$	DD 040 20 00 S03	115 \$
50 cm	DD 050 01 00 S03	95 \$	DD 050 00 00 S03	120 \$	DD 050 20 00 S03	135 \$
60 cm	DD 060 01 00 S03	110 \$	DD 060 00 00 S03	140 \$	DD 060 20 00 S03	155 \$
70 cm	DD 070 01 00 S03	125 \$	DD 070 00 00 S03	155 \$	DD 070 20 00 S03	175 \$
80 cm	DD 080 01 00 S03	135 \$	DD 080 00 00 S03	170 \$	DD 080 20 00 S03	185 \$
90 cm	DD 090 01 00 S03	165 \$	DD 090 00 00 S03	205 \$	DD 090 20 00 S03	225 \$



Sifon Tipi : S03

EBAT Size	Inox Satinox		Inox Ayna Mirror		Altın Ayna Gold	
30 cm	DD 030 01 00 S08	110 \$	DD 030 00 00 S08	130 \$	DD 030 20 00 S08	140 \$
40 cm	DD 040 01 00 S08	120 \$	DD 040 00 00 S08	140 \$	DD 040 20 00 S08	150 \$
50 cm	DD 050 01 00 S08	130 \$	DD 050 00 00 S08	155 \$	DD 050 20 00 S08	170 \$
60 cm	DD 060 01 00 S08	145 \$	DD 060 00 00 S08	175 \$	DD 060 20 00 S08	190 \$
70 cm	DD 070 01 00 S08	160 \$	DD 070 00 00 S08	190 \$	DD 070 20 00 S08	210 \$
80 cm	DD 080 01 00 S08	170 \$	DD 080 00 00 S08	205 \$	DD 080 20 00 S08	220 \$
90 cm	DD 090 01 00 S08	200 \$	DD 090 00 00 S08	240 \$	DD 090 20 00 S08	260 \$



Sifon Tipi : S08

S08

h : 30/80 mm
Karot ø: 110 mm - Care Drill Diameter ø: 110 mm
Kokusuz / Odor free



S10

h : 60 mm
Debi: 60 lt/dk - Flow: 60 lt/min
Kokusuz / Odor free



S11

h : 70 mm
Debi: 60 lt/dk - Flow: 60 lt/min
Kokusuz / Odor free





PH DESIGN

Prodrain invisible serisi duş alanlarında giderin gizlendiği sadece saplama malzemesinin ön planda olduğu çerçevesiz bir sistem sunuyor.

Prodrain invisible serisi ürünler;

-Yalıtım bitimli kaynaksız yekpare gövde, şap yüksekliğini için yükseklikayar seti, farklı montaj yükseklikleri ve drenaj kapasiteleri ile projelere uygun alternatif mekanik çözümler sunan, 360 derece dönebilen yüksek drenaj kapasiteli koku fermatürlü S sifon, saç tutucu, 20 cm genişliğinde bütül bant, uygulama sonrası oluşabilecek kot farklılıklarını önleyen yükseklik ayar setini uygulama kolaylığı sağlayacak şekilde standardize ederek Tek parça ürün olarak birleştiriyor ve kullanıcılara kolay montaj avantajı sunuyor.

EBAT Size	Inox Satinox	
30 cm	DD 030 01 06 S01	110 \$
40 cm	DD 040 01 06 S01	125 \$
50 cm	DD 050 01 06 S01	140 \$
60 cm	DD 060 01 06 S01	155 \$
70 cm	DD 070 01 06 S01	175 \$
80 cm	DD 080 01 06 S01	185 \$
90 cm	DD 090 01 06 S01	203 \$

EBAT Size	Inox Satinox	
30 cm	DD 030 01 06 S02	110 \$
40 cm	DD 040 01 06 S02	125 \$
50 cm	DD 050 01 06 S02	140 \$
60 cm	DD 060 01 06 S02	155 \$
70 cm	DD 070 01 06 S02	175 \$
80 cm	DD 080 01 06 S02	185 \$
90 cm	DD 090 01 06 S02	203 \$



Sifon Tipi : S01



Sifon Tipi : S02

S01

h : 60 mm
Debi: 51 lt/dk - Flow: 51 lt/min
Kokusuz / Odor free



S02

h : 70 mm
Debi: 48 lt/dk - Flow: 48 lt/min
Kokusuz / Odor free

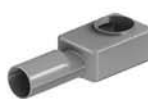

S03

h : 30/80 mm
Karot ø: 120mm -Core Drill Diameter ø: 120mm
Kokusuz / Odor free



EBAT Size	Inox Satinox	
30 cm	DD 030 01 06 S10	125 \$
40 cm	DD 040 01 06 S10	140 \$
50 cm	DD 050 01 06 S10	155 \$
60 cm	DD 060 01 06 S10	170 \$
70 cm	DD 070 01 06 S10	190 \$
80 cm	DD 080 01 06 S10	200 \$
90 cm	DD 090 01 06 S10	218 \$



Sifon Tipi : S10

EBAT Size	Inox Satinox	
30 cm	DD 030 01 06 S11	125 \$
40 cm	DD 040 01 06 S11	140 \$
50 cm	DD 050 01 06 S11	155 \$
60 cm	DD 060 01 06 S11	170 \$
70 cm	DD 070 01 06 S11	190 \$
80 cm	DD 080 01 06 S11	200 \$
90 cm	DD 090 01 06 S11	218 \$



Sifon Tipi : S11

EBAT Size	Inox Satinox	
30 cm	DD 030 01 06 S03	110 \$
40 cm	DD 040 01 06 S03	125 \$
50 cm	DD 050 01 06 S03	140 \$
60 cm	DD 060 01 06 S03	155 \$
70 cm	DD 070 01 06 S03	175 \$
80 cm	DD 080 01 06 S03	185 \$
90 cm	DD 090 01 06 S03	203 \$



Sifon Tipi : S03

EBAT Size	Inox Satinox	
30 cm	DD 030 01 06 S08	145 \$
40 cm	DD 040 01 06 S08	160 \$
50 cm	DD 050 01 06 S08	175 \$
60 cm	DD 060 01 06 S08	190 \$
70 cm	DD 070 01 06 S08	210 \$
80 cm	DD 080 01 06 S08	220 \$
90 cm	DD 090 01 06 S08	238 \$



Sifon Tipi : S08

S08

h : 30/80 mm
Karat ø: 110 mm - Care Drill Diameter ø: 110 mm
Kokusuz / Odor free



S10

h : 60 mm
Debi: 60 lt/dk - Flow: 60 lt/min
Kokusuz / Odor free



S11

h : 70 mm
Debi: 60 lt/dk - Flow: 60 lt/min
Kokusuz / Odor free





PH DESIGN

Prodrain serisi ile duş alanlarına modern , estetik ve kullanışlı çözümler sunuyor. Hemzemin uygulama karo ile bütünleşerek engelsiz banyolar yaratıyor. Yeni teknolojiyi kullanarak PATENTLİ CONTASIZ sistem ile sızdırmalıkta standartları yeniden belirleniyor.

Prodrain serisi ürünler;

-Yalıtım bitimli kaynaksız yekpare gövde, şap yüksekliğini için yükseklikayar seti, farklı montaj yükseklikleri ve drenaj kapasiteleri ile projelere uygun alternatif mekanik çözümler sunan, 360 derece dönebilen yüksek drenaj kapasiteli koku fermatürlü S sifon, saç tutucu, 20 cm genişliğinde bütül bant, uygulama sonrası oluşabilecek kot farklılıklarını önleyen yükseklik ayar setini uygulama kolaylığı sağlayacak şekilde standardize ederek Tek parça ürün olarak birleştiriyor ve kullanıcılara kolay montaj avantajı sunuyor.

EBAT Size	Inox Satinox	Inox Ayna Mirror	Altın Ayna Gold
30 cm	DD 030 01 01 S01 102 \$	DD 030 00 01 S01 129 \$	DD 030 20 01 S01 141 \$
40 cm	DD 040 01 01 S01 114 \$	DD 040 00 01 S01 144 \$	DD 040 20 01 S01 158 \$
50 cm	DD 050 01 01 S01 126 \$	DD 050 00 01 S01 159 \$	DD 050 20 01 S01 175 \$
60 cm	DD 060 01 01 S01 150 \$	DD 060 00 01 S01 189 \$	DD 060 20 01 S01 208 \$
70 cm	DD 070 01 01 S01 168 \$	DD 070 00 01 S01 212 \$	DD 070 20 01 S01 233 \$
80 cm	DD 080 01 01 S01 186 \$	DD 080 00 01 S01 234 \$	DD 080 20 01 S01 258 \$
90 cm	DD 090 01 01 S01 216 \$	DD 090 00 01 S01 272 \$	DD 090 20 01 S01 299 \$



Sifon Tipi : S01

EBAT Size	Inox Satinox	Inox Ayna Mirror	Altın Ayna Gold
30 cm	DD 030 01 01 S02 102 \$	DD 030 00 01 S02 129 \$	DD 030 20 01 S02 141 \$
40 cm	DD 040 01 01 S02 114 \$	DD 040 00 01 S02 144 \$	DD 040 20 01 S02 158 \$
50 cm	DD 050 01 01 S02 126 \$	DD 050 00 01 S02 159 \$	DD 050 20 01 S02 175 \$
60 cm	DD 060 01 01 S02 150 \$	DD 060 00 01 S02 189 \$	DD 060 20 01 S02 208 \$
70 cm	DD 070 01 01 S02 168 \$	DD 070 00 01 S02 212 \$	DD 070 20 01 S02 233 \$
80 cm	DD 080 01 01 S02 186 \$	DD 080 00 01 S02 234 \$	DD 080 20 01 S02 258 \$
90 cm	DD 090 01 01 S02 216 \$	DD 090 00 01 S02 272 \$	DD 090 20 01 S02 299 \$



Sifon Tipi : S02

S01

h : 60 mm
Debi: 51 lt/dk - Flow: 51 lt/min
Kokusuz / Odor free



S02

h : 70 mm
Debi: 48 lt/dk - Flow: 48 lt/min
Kokusuz / Odor free



S03

h : 30/80 mm
Karot ø: 120mm -Care Drill Diameter ø: 120mm
Kokusuz / Odor free



EBAT Size	Inox Satinox	Inox Ayna Mirror	Altın Ayna Gold
30 cm	DD 030 01 01 S10 117 \$	DD 030 00 01 S10 144 \$	DD 030 20 01 S10 156 \$
40 cm	DD 040 01 01 S10 129 \$	DD 040 00 01 S10 159 \$	DD 040 20 01 S10 173 \$
50 cm	DD 050 01 01 S10 141 \$	DD 050 00 01 S10 174 \$	DD 050 20 01 S10 190 \$
60 cm	DD 060 01 01 S10 165 \$	DD 060 00 01 S10 204 \$	DD 060 20 01 S10 223 \$
70 cm	DD 070 01 01 S10 183 \$	DD 070 00 01 S10 227 \$	DD 070 20 01 S10 248 \$
80 cm	DD 080 01 01 S10 201 \$	DD 080 00 01 S10 249 \$	DD 080 20 01 S10 273 \$
90 cm	DD 090 01 01 S10 231 \$	DD 090 00 01 S10 287 \$	DD 090 20 01 S10 314 \$



Sifon Tipi : S10

EBAT Size	Inox Satinox	Inox Ayna Mirror	Altın Ayna Gold
30 cm	DD 030 01 01 S11 117 \$	DD 030 00 01 S11 144 \$	DD 030 20 01 S11 156 \$
40 cm	DD 040 01 01 S11 129 \$	DD 040 00 01 S11 159 \$	DD 040 20 01 S11 173 \$
50 cm	DD 050 01 01 S11 141 \$	DD 050 00 01 S11 174 \$	DD 050 20 01 S11 190 \$
60 cm	DD 060 01 01 S11 165 \$	DD 060 00 01 S11 204 \$	DD 060 20 01 S11 223 \$
70 cm	DD 070 01 01 S11 183 \$	DD 070 00 01 S11 227 \$	DD 070 20 01 S11 248 \$
80 cm	DD 080 01 01 S11 201 \$	DD 080 00 01 S11 249 \$	DD 080 20 01 S11 273 \$
90 cm	DD 090 01 01 S11 231 \$	DD 090 00 01 S11 287 \$	DD 090 20 01 S11 314 \$



Sifon Tipi : S11

EBAT Size	Inox Satinox	Inox Ayna Mirror	Altın Ayna Gold
30 cm	DD 030 01 01 S03 102 \$	DD 030 00 01 S03 129 \$	DD 030 20 01 S03 141 \$
40 cm	DD 040 01 01 S03 114 \$	DD 040 00 01 S03 144 \$	DD 040 20 01 S03 158 \$
50 cm	DD 050 01 01 S03 126 \$	DD 050 00 01 S03 159 \$	DD 050 20 01 S03 175 \$
60 cm	DD 060 01 01 S03 150 \$	DD 060 00 01 S03 189 \$	DD 060 20 01 S03 208 \$
70 cm	DD 070 01 01 S03 168 \$	DD 070 00 01 S03 212 \$	DD 070 20 01 S03 233 \$
80 cm	DD 080 01 01 S03 186 \$	DD 080 00 01 S03 234 \$	DD 080 20 01 S03 258 \$
90 cm	DD 090 01 01 S03 216 \$	DD 090 00 01 S03 272 \$	DD 090 20 01 S03 299 \$



Sifon Tipi : S03

EBAT Size	Inox Satinox	Inox Ayna Mirror	Altın Ayna Gold
30 cm	DD 030 01 01 S08 137 \$	DD 030 00 01 S08 164 \$	DD 030 20 01 S08 176 \$
40 cm	DD 040 01 01 S08 149 \$	DD 040 00 01 S08 179 \$	DD 040 20 01 S08 193 \$
50 cm	DD 050 01 01 S08 161 \$	DD 050 00 01 S08 194 \$	DD 050 20 01 S08 210 \$
60 cm	DD 060 01 01 S08 185 \$	DD 060 00 01 S08 224 \$	DD 060 20 01 S08 243 \$
70 cm	DD 070 01 01 S08 203 \$	DD 070 00 01 S08 247 \$	DD 070 20 01 S08 268 \$
80 cm	DD 080 01 01 S08 221 \$	DD 080 00 01 S08 269 \$	DD 080 20 01 S08 293 \$
90 cm	DD 090 01 01 S08 251 \$	DD 090 00 01 S08 307 \$	DD 090 20 01 S08 334 \$



Sifon Tipi : S08

S08

h : 30/80 mm
Karot ø: 110 mm - Care Drill Diameter ø: 110 mm
Kokusuz / Odor free



S10

h : 60 mm
Debi: 60 lt/dk - Flow: 60 lt/min
Kokusuz / Odor free



S11

h : 70 mm
Debi: 60 lt/dk - Flow: 60 lt/min
Kokusuz / Odor free



Uygulama Kesit :

1. Döşeme Betonunu / Covering Concrete
2. Tesviye Betonunu / Levelling Concrete
3. Ph Dizayn Butil Bant / ph design Butil Bant
4. İzolasyon Katmanı / Insulation Layer
5. Yapıştırıcı / Adhesive
6. Kaplama Malzemesi / Covering

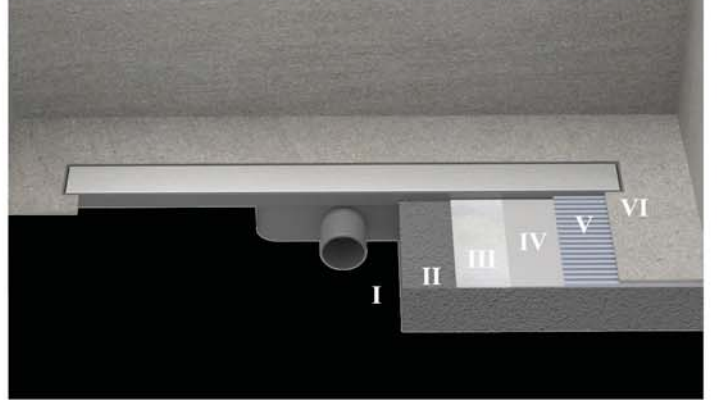

Sifon Tipi : S07

Kapak (1.5 mm kalınlık) / Top cover (1.5 mm)

Saç Tutucu Süzgeç / Hair Holder

ABS Ana Gövde + S Sifon / ABS Main Body + S Siphon

Yükseklik Ayar Parçası / Height Adjustment Kit

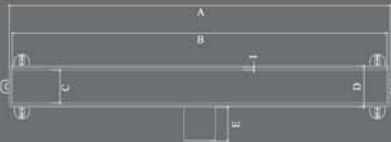
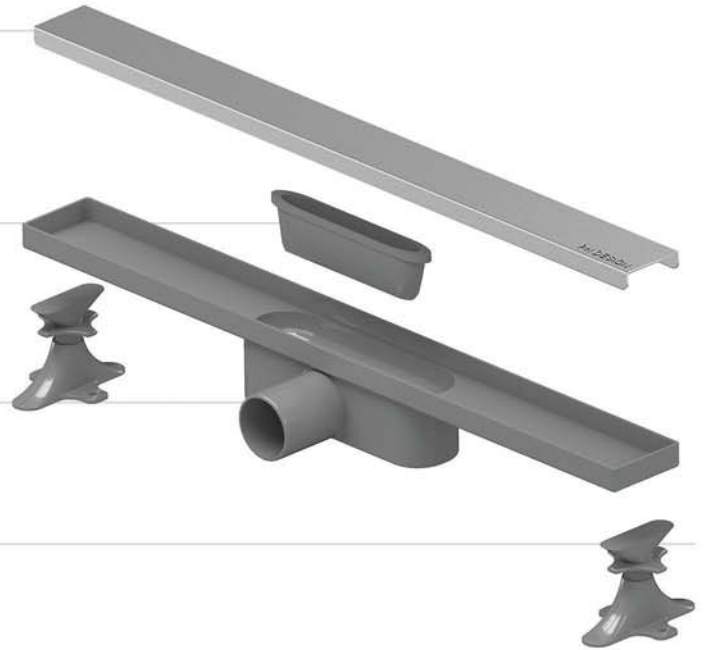

	30	40	50	60	70	80	90
A	30	40	50	60	70	80	90
B	29	39	49	59	69	79	89
C	5.2	5.2	5.2	5.2	5.2	5.2	5.2
D	6.5	6.5	6.5	6.5	6.5	6.5	6.5
E	5.4	5.4	5.4	5.4	5.4	5.4	5.4
F	2	2	2	2	2	2	2
G	5	5	5	5	5	5	5
H	19	19	19	19	19	19	19
I	0.5	0.5	0.5	0.5	0.5	0.5	0.5
J	7.3	7.3	7.3	7.3	7.3	7.3	7.3



EBAT Size	Inox / Linear Satinox	
30 cm	DB 030 01 00 S07	45 \$
40 cm	DB 040 01 00 S07	50 \$
50 cm	DB 050 01 00 S07	55 \$
60 cm	DB 060 01 00 S07	65 \$
70 cm	DB 070 01 00 S07	70 \$
80 cm	DB 080 01 00 S07	75 \$
90 cm	DB 090 01 00 S07	80 \$



Sifon Tipi : S07

EBAT Size	Inox / Greek Satinox	
30 cm	DB 030 01 01 S07	45 \$
40 cm	DB 040 01 01 S07	50 \$
50 cm	DB 050 01 01 S07	55 \$
60 cm	DB 060 01 01 S07	65 \$
70 cm	DB 070 01 01 S07	70 \$
80 cm	DB 080 01 01 S07	75 \$
90 cm	DB 090 01 01 S07	80 \$



Sifon Tipi : S07



Ph Standart yer süzgeçleri özel tasarlanan koku önleyici sistem ile ıslak mekanlara özel çözümler sağlamaktadır.

Ph Standart drains give special solutions for your bathrooms with its design. With its insulation skirt and odor sealing properties meet the technical expectations.

EBAT Size	Inox Satinox	Inox Ayna Mirror	Altın Ayna Gold	Bakır Ayna Bronze				
10 x 10 cm Ø : 32	PD0100118S06	12 \$	PD0100018S06	15 \$	PD0102018S06	18 \$	PD0103018S06	22 \$
10 x 10 cm Ø : 50	PD0100118S12	20 \$	PD0100018S12	25 \$	PD0102018S12	30 \$	PD0103018S12	37 \$

PH SMART

PH Smart yer süzgeçleri yalıtım etekli olarak kare, yuvarlak ve üçgen seçenekleriyle sunulmaktadır. 3 mm masif farklı dizaynlarda ve şekillerde kapak seçenekleri ve özel tasarlanan koku önleyici sistemi ile ıslak mekanlara özel çözümler sağlamaktadır.

PH Smart drains give special solutions for your bathroom with its design. With its insulation skirt and odor sealing properties meet the technical expectations.

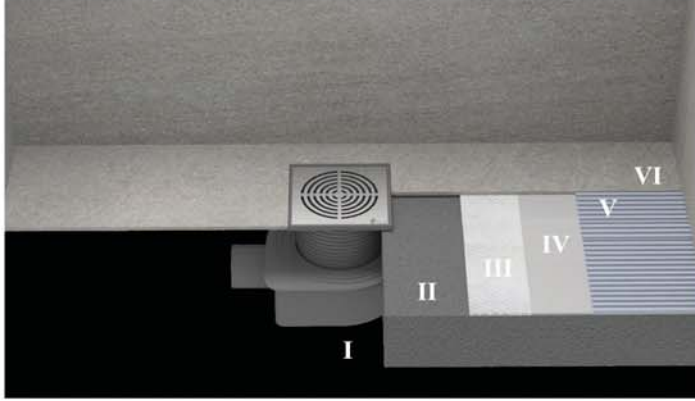

Uygulama Kesit :

1. Döşeme Betonu / Covering Concrete
2. Tesviye Betonu / Levelling Concrete
3. Ph Dizayn Butil Bant / ph design Butil Bant
4. İzolasyon Katmanı / Insulation Layer
5. Yapıştırıcı / Adhesive
6. Kaplama Malzemesi / Covering

Sifon Tipi : S04

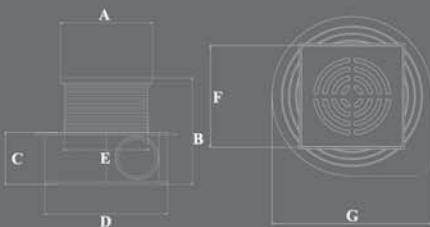

	10	15
A	10	15
B	AYARLANABİLİR YÜKSEKLİK	AYARLANABİLİR YÜKSEKLİK
C	6	6
D	14	14
E	9.6	9.6
F	10	15
G	16	16

Uygulama Kesit :

1. Döşeme Betonu / Covering Concrete
2. Tesviye Betonu / Levelling Concrete
3. Ph Dizayn Butil Bant / ph design Butil Bant
4. İzolasyon Katmanı / Insulation Layer
5. Yapıştırıcı / Adhesive
6. Kaplama Malzemesi / Covering

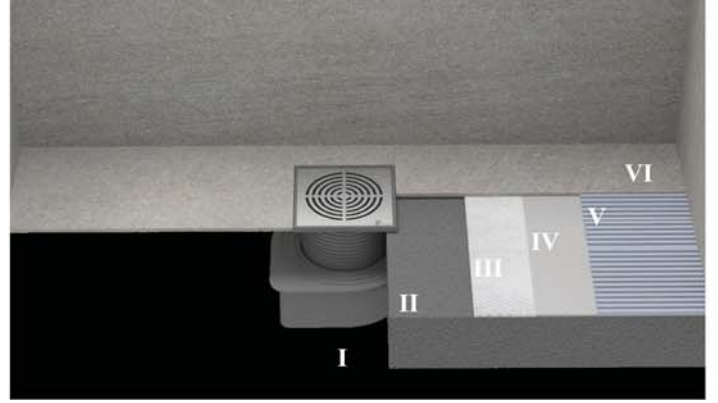

Sifon Tipi : S05

Kapak (1.5 mm kalınlık) / Top cover (1.5 mm)

Saç Tutucu Süzgeç / Hair Holder

Koku Önleyici / Prevent Odor System

Yükseklik Ayar Çerçevesi / Final Height Adjustment Frame

Yalıtım Flanşı / Insulating Flange

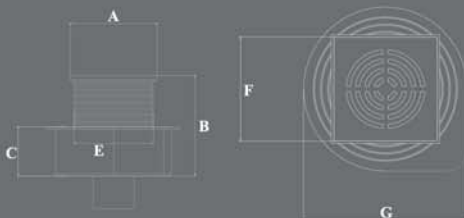

	10	15
A	10	15
B	AYARLANABİLİR YÜKSEKLİK / AYARLANABİLİR YÜKSEKLİK	
C	6	6
D	14	14
E	9.6	9.6
F	10	15
G	16	16

Uygulama Kesit :

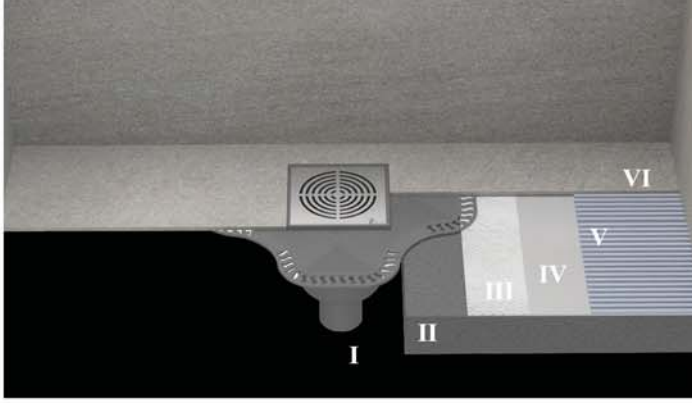

1. Döşeme Betonu / Covering Concrete
2. Tesviye Betonu / Levelling Concrete
3. Ph Dizayn Butil Bant / ph design Butil Bant
4. İzolasyon Katmanı / Insulation Layer
5. Yapıştırıcı / Adhesive
6. Kaplama Malzemesi / Covering

Sifon Tipi : S08



Kapak (1.5 mm kalınlık) / Top cover (1.5 mm)

Saç Tutucu Süzgeç / Hair Holder

Koku Önleyici / Prevent Odor System

Yükseklik Ayar Çerçevesi / Final Height Adjustment Frame

Yalıtım Flanşı / Insulating Flange

S Sifon / S Siphon

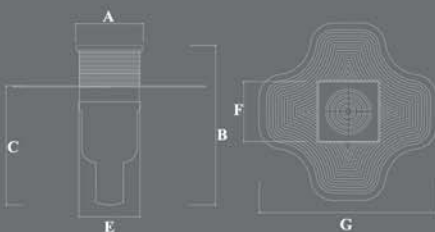

	10	15
A	10	15
B	AYARLANABİLİR YÜKSEKLİK	AYARLANABİLİR YÜKSEKLİK
C	18	18
E	9.6	9.6
F	10	15
G	30	30

Uygulama Kesit :

1. Döşeme Betonu / Covering Concrete
2. Tesviye Betonu / Levelling Concrete
3. Ph Dizayn Butil Bant / ph design Butil Bant
4. İzolasyon Katmanı / Insulation Layer
5. Yapıştırıcı / Adhesive
6. Kaplama Malzemesi / Covering

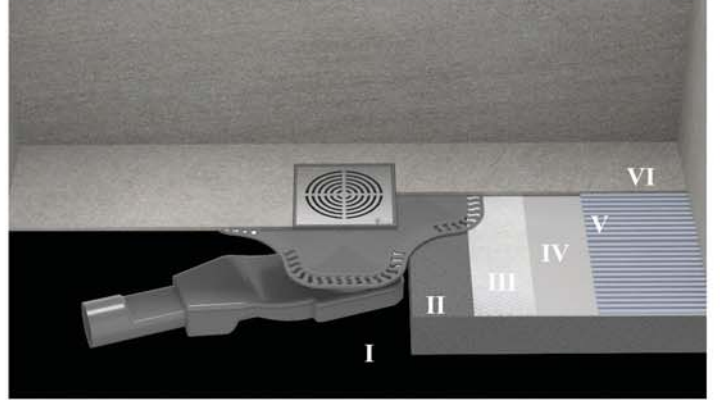

Sifon Tipi : S09

Kapak (1.5 mm kalınlık) / Top cover (1.5 mm)

Saç Tutucu Süzgeç / Hair Holder

Koku Önleyici / Prevent Odor System

Yükseklik Ayar Çerçevesi / Final Height Adjustment Frame

Yalıtım Flanşı / Insulating Flange

S Sifon / S Siphon

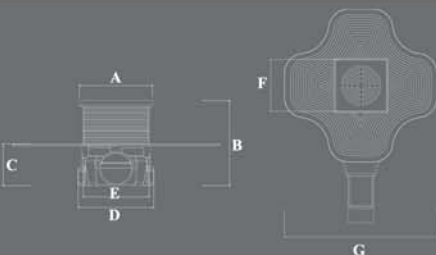

	10	15
A	10	15
B	AYARLANABİLİR YÜKSEKLİK AYARLANABİLİR YÜKSEKLİK	
C	6	6
D	11	11
E	9.6	9.6
F	10	15
G	30	30



DESIGN - 1



DESIGN - 5

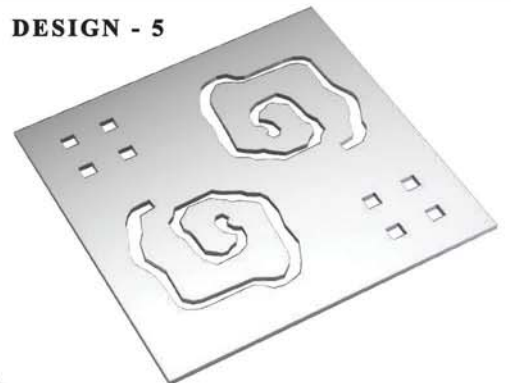

DESIGN - 2



DESIGN - 3



DESIGN - 4

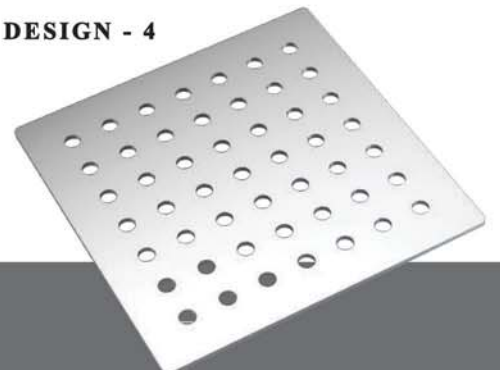

	EBAT size	Inox Satinox		Inox Ayna Mirror		Altın Ayna Gold		Sifon Tipi : S04	Sifon Tipi : S05
DESIGN - 1	10 cm / S04	DS 010 01 13 S04	35 \$	DS 010 00 13 S04	42 \$	DS 010 20 13 S04	50 \$		
	10 cm / S05	DS 010 01 13 S05	35 \$	DS 010 00 13 S05	42 \$	DS 010 20 13 S05	50 \$		
	15 cm / S04	DS 015 01 13 S04	45 \$	DS 015 00 13 S04	55 \$	DS 015 20 13 S04	65 \$		
	15 cm / S05	DS 015 01 13 S05	45 \$	DS 015 00 13 S05	55 \$	DS 015 20 13 S05	65 \$		
DESIGN - 2	10 cm / S04	DS 010 01 14 S04	35 \$	DS 010 00 14 S04	42 \$	DS 010 20 14 S04	50 \$		
	10 cm / S05	DS 010 01 14 S05	35 \$	DS 010 00 14 S05	42 \$	DS 010 20 14 S05	50 \$		
	15 cm / S04	DS 015 01 14 S04	45 \$	DS 015 00 14 S04	55 \$	DS 015 20 14 S04	65 \$		
	15 cm / S05	DS 015 01 14 S05	45 \$	DS 015 00 14 S05	55 \$	DS 015 20 14 S05	65 \$		
DESIGN - 3	10 cm / S04	DS 010 01 15 S04	35 \$	DS 010 00 15 S04	42 \$	DS 010 20 15 S04	50 \$		
	10 cm / S05	DS 010 01 15 S05	35 \$	DS 010 00 15 S05	42 \$	DS 010 20 15 S05	50 \$		
	15 cm / S04	DS 015 01 15 S04	45 \$	DS 015 00 15 S04	55 \$	DS 015 20 15 S04	65 \$		
	15 cm / S05	DS 015 01 15 S05	45 \$	DS 015 00 15 S05	55 \$	DS 015 20 15 S05	65 \$		
DESIGN - 4	10 cm / S04	DS 010 01 16 S04	35 \$	DS 010 00 16 S04	42 \$	DS 010 20 16 S04	50 \$		
	10 cm / S05	DS 010 01 16 S05	35 \$	DS 010 00 16 S05	42 \$	DS 010 20 16 S05	50 \$		
	15 cm / S04	DS 015 01 16 S04	45 \$	DS 015 00 16 S04	55 \$	DS 015 20 16 S04	65 \$		
	15 cm / S05	DS 015 01 16 S05	45 \$	DS 015 00 16 S05	55 \$	DS 015 20 16 S05	65 \$		
DESIGN - 5	10 cm / S04	DS 010 01 17 S04	35 \$	DS 010 00 17 S04	42 \$	DS 010 20 17 S04	50 \$		
	10 cm / S05	DS 010 01 17 S05	35 \$	DS 010 00 17 S05	42 \$	DS 010 20 17 S05	50 \$		
	15 cm / S04	DS 015 01 17 S04	45 \$	DS 015 00 17 S04	55 \$	DS 015 20 17 S04	65 \$		
	15 cm / S05	DS 015 01 17 S05	45 \$	DS 015 00 17 S05	55 \$	DS 015 20 17 S05	65 \$		

	EBAT size	Inox Satinox		Inox Ayna Mirror		Altın Ayna Gold		Sifon Tipi : S08	Sifon Tipi : S09
DESIGN - 1	10 cm / S08	DS 010 01 13 S08	55 \$	DS 010 00 13 S08	65 \$	DS 010 20 13 S08	75 \$		
	10 cm / S09	DS 010 01 13 S09	55 \$	DS 010 00 13 S09	65 \$	DS 010 20 13 S09	75 \$		
	15 cm / S08	DS 015 01 13 S08	70 \$	DS 015 00 13 S08	85 \$	DS 015 20 13 S08	95 \$		
	15 cm / S09	DS 015 01 13 S09	70 \$	DS 015 00 13 S09	85 \$	DS 015 20 13 S09	95 \$		
DESIGN - 2	10 cm / S08	DS 010 01 14 S08	55 \$	DS 010 00 14 S08	65 \$	DS 010 20 14 S08	75 \$		
	10 cm / S09	DS 010 01 14 S09	55 \$	DS 010 00 14 S09	65 \$	DS 010 20 14 S09	75 \$		
	15 cm / S08	DS 015 01 14 S08	70 \$	DS 015 00 14 S08	85 \$	DS 015 20 14 S08	95 \$		
	15 cm / S09	DS 015 01 14 S09	70 \$	DS 015 00 14 S09	85 \$	DS 015 20 14 S09	95 \$		
DESIGN - 3	10 cm / S08	DS 010 01 15 S08	55 \$	DS 010 00 15 S08	65 \$	DS 010 20 15 S08	75 \$		
	10 cm / S09	DS 010 01 15 S09	55 \$	DS 010 00 15 S09	65 \$	DS 010 20 15 S09	75 \$		
	15 cm / S08	DS 015 01 15 S08	70 \$	DS 015 00 15 S08	85 \$	DS 015 20 15 S08	95 \$		
	15 cm / S09	DS 015 01 15 S09	70 \$	DS 015 00 15 S09	85 \$	DS 015 20 15 S09	95 \$		
DESIGN - 4	10 cm / S08	DS 010 01 16 S08	55 \$	DS 010 00 16 S08	65 \$	DS 010 20 16 S08	75 \$		
	10 cm / S09	DS 010 01 16 S09	55 \$	DS 010 00 16 S09	65 \$	DS 010 20 16 S09	75 \$		
	15 cm / S08	DS 015 01 16 S08	70 \$	DS 015 00 16 S08	85 \$	DS 015 20 16 S08	95 \$		
	15 cm / S09	DS 015 01 16 S09	70 \$	DS 015 00 16 S09	85 \$	DS 015 20 16 S09	95 \$		
DESIGN - 5	10 cm / S08	DS 010 01 17 S08	55 \$	DS 010 00 17 S08	65 \$	DS 010 20 17 S08	75 \$		
	10 cm / S09	DS 010 01 17 S09	55 \$	DS 010 00 17 S09	65 \$	DS 010 20 17 S09	75 \$		
	15 cm / S08	DS 015 01 17 S08	70 \$	DS 015 00 17 S08	85 \$	DS 015 20 17 S08	95 \$		
	15 cm / S09	DS 015 01 17 S09	70 \$	DS 015 00 17 S09	85 \$	DS 015 20 17 S09	95 \$		

* Bütül bant ürün fiyatına dahil değildir.

YARDIMCI MEYİL PROFİLLERİ

SLOPE PROFILES

Duş kanalları kullanılan alanlarda bitiş sağlamak amacıyla kullanılan paslanmaz çelik eğim profilidir. Yıkama alanıyla banyo alanının kot farklılığı için temiz bitiş sağlar.

Slope profile that provides clean finishes for application. Can be use at all shower areas two different shape alternatives: left and right alternatives. Three different surface alternatives.

EĞİMLİ PROFİL

SLOPE PROFILE

	SAĞ 100 cm Right		SOL 100 cm Left	
Inox/Satinox	PEP100R01	32,5 \$	PEP100L01	32,5 \$
Inox Ayna/Mirror	PEP100R00	41,6 \$	PEP100L00	41,6 \$
Altın Ayna/Gold	PEP100R20	49,4 \$	PEP100L20	49,4 \$
	SAĞ 150 cm Right		SOL 150 cm Left	
Inox/Satinox	PEP150R01	41,6 \$	PEP150L01	41,6 \$
Inox Ayna/Mirror	PEP150R00	52,0 \$	PEP150L00	52,0 \$
Altın Ayna/Gold	PEP150R20	62,4 \$	PEP150L20	62,4 \$

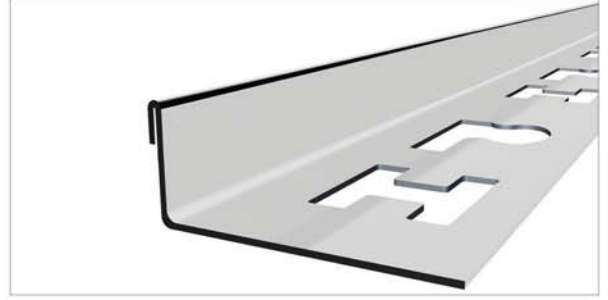

EĞİMSİZ PROFİL

FLAT PROFILE

	250 cm	
Inox/Satinox	EPP25001	75,40 \$
Inox Ayna/Mirror	EPP25000	96,20 \$
Altın Ayna/Gold	EPP25020	111,8 \$

HARİCİ ÇERÇEVE (PRODRAIN SERİSİ İÇİN KULLANILIR !)

EXTERNAL FRAME

EBAT Size	Inox Satinox	
30 cm	PÇ03001	11,7 \$
40 cm	PÇ04001	14,3 \$
50 cm	PÇ05001	15,6 \$
60 cm	PÇ06001	18,2 \$
70 cm	PÇ07001	20,8 \$
80 cm	PÇ08001	23,4 \$
90 cm	PÇ09001	26,3 \$
120 cm	PÇ12001	38,0 \$

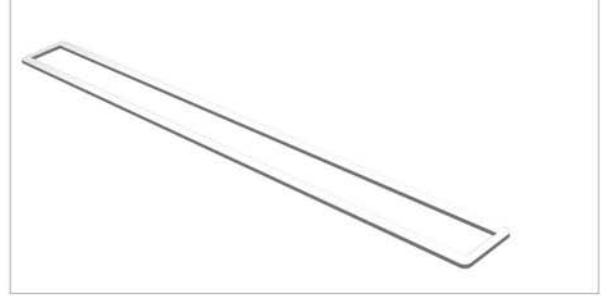

DUŞ KABİNİ CAM PROFİLİ

SHOWER ENCLOSURE GLASS PROFILE

EBAT Size	Inox Satinox		Inox Parlak Shine	
8 mm / 10 mm	PC100825001	43,5 \$	PC100825003	43,5 \$
10 mm / 10 mm	PC101025001	44,0 \$	PC101025003	44,0 \$
12 mm / 10 mm	PC101225001	44,5 \$	PC101225003	44,5 \$
8 mm / 13 mm	PC130825001	43,5 \$	PC130825003	43,5 \$
10 mm / 13 mm	PC131025001	44,0 \$	PC131025003	44,0 \$
12 mm / 13 mm	PC131225001	44,5 \$	PC131225003	44,5 \$

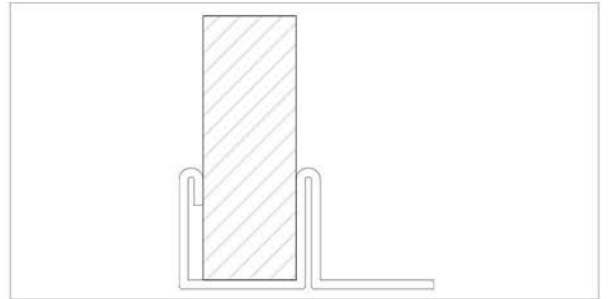

BÜTİL BANT

BUTYL BAND

PBT020011	20 cm linear süzgeç bütül bant (sızdırmaz)	14,3 \$/m
PBT040011	40 x 40 cm bütül bant (sızdırmaz)	20,8 \$/adet

TECHNOLINE

Paslanmaz Çelik Teknik Profil

Technoline serisi teknik profiller yüksek dayanıklılığa sahip 304 kalite paslanmaz çelikten üretilmektedir. Technoline paslanmaz çelik teknik profiller mukavemetinin oldukça yüksek olması, renk alternatiflerinin geniş olması ve renklerin pvd kaplama ile oluşturulması sonucu derz dolgu malzemelerinden etkilenmemesi özelliği ile alternatiflerine (plastik ve alüminyum) oranla tercih sebebi olmaktadır. Technoline ürünler 10 farklı renk seçeneği sunmaktadır.



Stainless Steel Technical Profile

TECHNICAL PROFILES are produced 304 quality 1st stainless steel. Stainless steel profiles create lighting or opaque effects to define and delineate different spaces and through their various heights, from 8mm, 10mm, 12mm, 14mm they can be combined with all types of tiles Technoline creates unusual combinations and contrasts with endless variations of materials, different colour and finishes. Technoline are designed to provide a long-lasting finish and corrosion resistance to ceramic and floor tiles. Technical profiles are covered with a special protection film for easy application. Offered 10 different surface options and length are 244 cm and 250 cm.

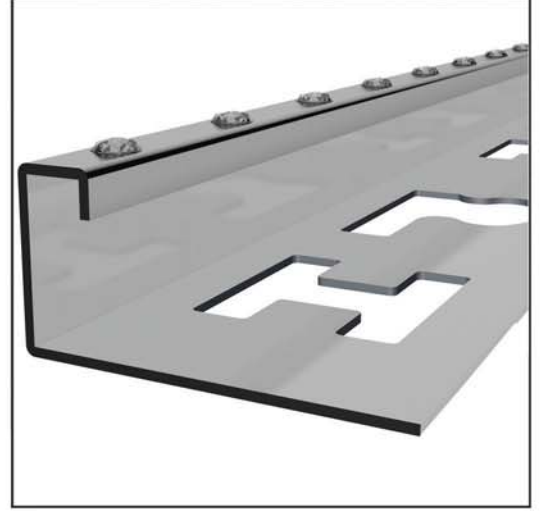

Ebat size	Inox satinox		Dekorlu decor		Altın s gold		Bakır s bronze		Antrasit s. anthracite	
8 mm	PFS0825001	200 \$	PFS0825011	212,5 \$	PFS0824421	218,7 \$	PFS0824431	237,5 \$	PFS0824441	231,2 \$
10 mm	PFS1025001	200 \$	PFS1025011	212,5 \$	PFS1024421	218,7 \$	PFS1024431	237,5 \$	PFS1024441	231,2 \$
12 mm	PFS1225001	200 \$	PFS1225011	212,5 \$	PFS1224421	218,7 \$	PFS1224431	237,5 \$	PFS1224441	231,2 \$
14 mm	PFS1425001	200 \$	PFS1425011	212,5 \$	PFS1424421	218,7 \$	PFS1424431	237,5 \$	PFS1424441	231,2 \$

Ebat size	Inox Ayna mirror		Inox Parlak shine		Altın Ayna gold		Bakır Ayna bronze		Antrasit Ayna anthracite	
8 mm	PFS0824400	212,5 \$	PFS0825003	200 \$	PFS0824420	218,7 \$	PFS0824430	237,5 \$	PFS0824440	231,2 \$
10 mm	PFS1024400	212,5 \$	PFS1025003	200 \$	PFS1024420	218,7 \$	PFS1024430	237,5 \$	PFS1024440	231,2 \$
12 mm	PFS1224400	212,5 \$	PFS1225003	200 \$	PFS1224420	218,7 \$	PFS1224430	237,5 \$	PFS1224440	231,2 \$
14 mm	PFS1424400	212,5 \$	PFS1425003	200 \$	PFS1424420	218,7 \$	PFS1424430	237,5 \$	PFS1424440	231,2 \$

Diamond Shine seramik yüzeylerin dış köşelerini korumak amacıyla kullanılan dekoratif görünümlü paslanmaz çelikten üretilen dik açılı bitiş profilidir.

Seramik yüzeylerin dış köşelerini korumak için 304 kalite paslanmaz çelikten üretilen dik açılı bitiş profilidir. 10 farklı renk alternatifi ile üretilmektedir.

Renkli ürünler PVD teknolojisi ile paslanmaz yüzeye yüksek dayanıma sahip titanyum iyon kaplama yöntemi ile üretilmektedir.

Diamond Shine is internal outer edge protection profile produced from 4301 grade stainless steel with offered 10 different surface colour options. All colour options produced by PVD technologies with high resistance titanium covered.

Inox (Satinox), Dekorlu (Decor), Inox Parlak (Shine) yüzeyler 250 cm boyda üretilmektedir. / Surfaces 250 cm length. Ayna (Mirror), Altın (Satine Gold), Altın ayna (Gold), Bakır (Satine bronze), Bakır Ayna (Bronze mirror), Antrasit (Satine Anthracite), Antrasit ayna (Anthracite mirror) yüzeyler 244 cm boyda üretilmektedir. / surfaces 244 cm length. Maximum boy 300 cm üretilmektedir. / Profile can be produced up to 300 cm. Paket içi adedi: 1 ADET / Products per box. Belirtilen hammadde kalınlıkları 0,80 mm dir, 0,60 mm için fiyat talep edilmelidir. Thickness is 0,80 mm. Should be request price for 0,60 mm alternatives.

TEKNİK ÖLÇÜ TABLOSU

	8 mm	10 mm	12 mm	14 mm
W	5,5	5,5	5,5	5,5
H	10	12	14	16

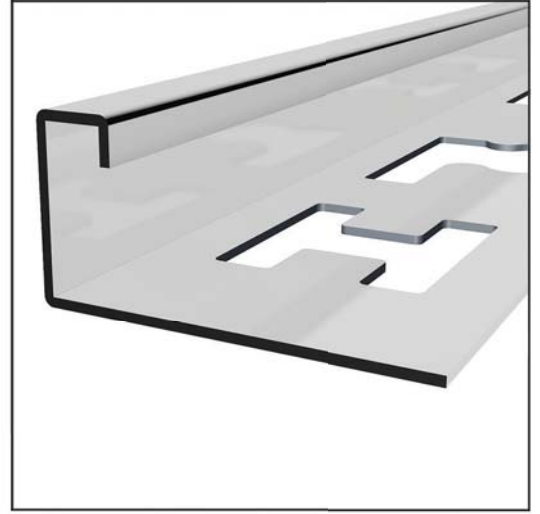

Ebat size	Inox satinox	Dekorlu decor	Altın s gold	Bakır s bronze	Antrasit s. anthracite
8 mm	PF0825001	22,5 \$ PF0825011	31,0 \$ PF0824421	30,5 \$ PF0824431	42,0 \$ PF0824441
10 mm	PF1025001	23,0 \$ PF1025011	31,5 \$ PF1024421	31,0 \$ PF1024431	42,5 \$ PF1024441
12 mm	PF1225001	23,5 \$ PF1225011	32,0 \$ PF1224421	31,5 \$ PF1224431	43,0 \$ PF1224441
14 mm	PF1425001	24,0 \$ PF1425011	32,5 \$ PF1424421	32,0 \$ PF1424431	43,5 \$ PF1424441
Ebat size	Inox Ayna mirror	Inox Parlak shine	Altın Ayna gold	Bakır Ayna bronze	Antrasit Ayna anthracite
8 mm	PF0824400	26,5 \$ PF0825003	22,5 \$ PF0824420	30,5 \$ PF0824430	42,0 \$ PF0824440
10 mm	PF1024400	27,0 \$ PF1025003	23,0 \$ PF1024420	31,0 \$ PF1024430	42,5 \$ PF1024440
12 mm	PF1224400	27,5 \$ PF1225003	23,5 \$ PF1224420	31,5 \$ PF1224430	43,0 \$ PF1224440
14 mm	PF1424400	28,0 \$ PF1425003	24,0 \$ PF1424420	32,0 \$ PF1424430	43,5 \$ PF1424440

Profix F Seramik yüzeylerin dış köşelerini korumak amacıyla kullanılan dekoratif görünümlü paslanmaz çelikten üretilen dik açılı bitiş profilidir. Seramik yüzeylerin dış köşelerini korumak için 304 kalite paslanmaz çelikten üretilen dik açılı bitiş profilidir. 10 farklı renk alternatif ile üretilmektedir. Renkli ürünler PVD teknolojisi ile paslanmaz yüzeye yüksek dayanıma sahip titanyum iyon kaplama yöntemi ile üretilmektedir. Profix F is internal outer edge protection profile produced from 4301 grade stainless steel with offered 10 different surface colour options. All colour options produced by PVD technologies with high resistance titanium covered.

Inox (Satinox), Dekorlu (Decor), Inox Parlak (Shine) yüzeyler 250 cm boyda üretilmektedir. / Surfaces 250 cm length. Ayna (Mirror), Altın (Satine Gold), Altın ayna (Gold), Bakır (Satine bronze), Bakır Ayna (Bronze mirror), Antrasit (Satine Anthracite), Antrasit ayna (Anthracite mirror) yüzeyler 244 cm boyda üretilmektedir. / surfaces 244 cm length. Maximum boy 300 cm üretilmektedir. / Profile can be produced up to 300 cm. Paket içi adeti: 6 ADET / Products per box. Belirtilen hammadde kalınlıkları 0,80 mm dir, 0,60 mm için fiyat talep edilmelidir. Thickness is 0,80 mm. Should be request price for 0,60 mm alternatives.

		TEKNİK ÖLÇÜ TABLOSU			
		8 mm	10 mm	12 mm	14 mm
	W	5,5	5,5	5,5	5,5
	H	10	12	14	16



Ebat size	Inox satinox	Dekorlu decor	Altın s gold	Bakır s bronze	Antrasit s. anthracite
8 mm	PQ0825001 22,5 \$	PQ0825011 31,0 \$	PQ0824421 30,5 \$	PQ0824431 42,0 \$	PQ0824441 42,0 \$
10 mm	PQ1025001 23,0 \$	PQ1025011 31,5 \$	PQ1024421 31,0 \$	PQ1024431 42,5 \$	PQ1024441 42,5 \$
12 mm	PQ1225001 23,5 \$	PQ1225011 32,0 \$	PQ1224421 31,5 \$	PQ1224431 43,0 \$	PQ1224441 43,0 \$
14 mm	PQ1425001 24,0 \$	PQ1425011 32,5 \$	PQ1424421 32,0 \$	PQ1424431 43,5 \$	PQ1424441 43,5 \$

Ebat size	Inox Ayna mirror	Inox Parlak shine	Altın Ayna gold	Bakır Ayna bronze	Antrasit Ayna anthracite
8 mm	PQ0824400 26,5 \$	PQ0825003 22,5 \$	PQ0824420 30,5 \$	PQ0824430 42,0 \$	PQ0824440 42,0 \$
10 mm	PQ1024400 27,0 \$	PQ1025003 23,0 \$	PQ1024420 31,0 \$	PQ1024430 42,5 \$	PQ1024440 42,5 \$
12 mm	PQ1224400 27,5 \$	PQ1225003 23,5 \$	PQ1224420 31,5 \$	PQ1224430 43,0 \$	PQ1224440 43,0 \$
14 mm	PQ1424400 28,0 \$	PQ1425003 24,0 \$	PQ1424420 32,0 \$	PQ1424430 43,5 \$	PQ1424440 43,5 \$

Profix Q seramik yüzeylerin dış köşelerini korumak amacıyla kullanılan dekoratif görünümlü paslanmaz çelikten üretilen kare köşe koruma profilidir. Seramik yüzeylerin dış köşelerini korumak için 304 kalite paslanmaz çelikten üretilen kare bitiş profilidir. 10 farklı renk alternatifi ile üretilmektedir. Renkli ürünler PVD teknolojisi ile paslanmaz yüzeye yüksek dayanıma sahip titanyum iyon kaplama yöntemi ile üretilmektedir. Profix Q is square corner edge protection profile produced from 4301 grade stainless steel with offered 10 different surface colour options. All color options produced by PVD technologies with high resistance titanium ion covered .

Inox (Satinox), Dekorlu (Decor), Inox Parlak (Shine) yüzeyler 250 cm boyda üretilmektedir. / Surfaces 250 cm lenght. Ayna (Mirror), Altın (Satine Gold), Altın ayna (Gold), Bakır (Satine bronze), Bakır Ayna (Bronze mirror), Antrasit (Satine Anthracite), Antrasit ayna (Anthracite mirror) yüzeyler 244 cm boyda üretilmektedir. / surfaces 244 cm lenght. Maximum boy 300 cm üretilmektedir. / Profile can be produced up to 300 cm. Paket içi adeti: 10 ADET / Products per box. Belirtilen hammadde kalınlıkları 0,80 mm dir, 0,60 mm için fiyat talep edilmelidir. Thickness is 0,80 mm. Should be request price for 0,60 mm alternatives.

TEKNİK ÖLÇÜ TABLOSU

	8 mm	10 mm	12 mm	14 mm
W	8,5	8,5	8,5	8,5
H	10	12	14	16

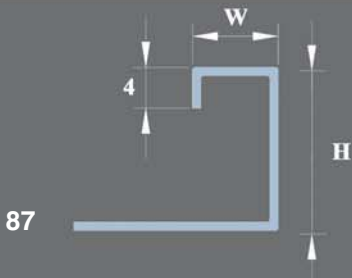



Ebat size	Inox satinox	Dekorlu decor	Altın s gold	Bakır s bronz	Antrasit s. anthracite
8 mm	TQ0825001 18,0 \$	TQ0825011 24,8 \$	TQ0824421 24,4 \$	TQ0824431 33,6 \$	TQ0824441 33,6 \$
10 mm	TQ1025001 18,4 \$	TQ1025011 25,2 \$	TQ1024421 24,8 \$	TQ1024431 34,0 \$	TQ1024441 34,0 \$
12 mm	TQ1225001 18,8 \$	TQ1225011 25,6 \$	TQ1224421 25,2 \$	TQ1224431 34,4 \$	TQ1224441 34,4 \$
14 mm	TQ1425001 19,2 \$	TQ1425011 26,0 \$	TQ1424421 25,6 \$	TQ1424431 34,8 \$	TQ1424441 34,8 \$

Ebat size	Inox Ayna mirror	Inox Parlak shine	Altın Ayna gold	Bakır Ayna bronz	Antrasit Ayna anthracite
8 mm	TQ0824400 21,2 \$	TQ0825003 18,0 \$	TQ0824420 24,4 \$	TQ0824430 33,6 \$	TQ0824440 33,6 \$
10 mm	TQ1024400 21,6 \$	TQ1025003 18,4 \$	TQ1024420 24,8 \$	TQ1024430 34,0 \$	TQ1024440 34,0 \$
12 mm	TQ1224400 22,0 \$	TQ1225003 18,8 \$	TQ1224420 25,2 \$	TQ1224430 34,4 \$	TQ1224440 34,4 \$
14 mm	TQ1424400 22,4 \$	TQ1425003 19,2 \$	TQ1424420 25,6 \$	TQ1424430 34,8 \$	TQ1424440 34,8 \$

Profix QE seramik yüzeylerin dış köşelerini korumak amacıyla kullanılan dekoratif görünümlü paslanmaz çelikten üretilen kare köşe koruma profilidir. Seramik yüzeylerin dış köşelerini korumak için 304 kalite paslanmaz çelikten üretilen kare bitiş profilidir. 10 farklı renk alternatifi ile üretilmektedir. Renkli ürünler PVD teknolojisi ile paslanmaz yüzeye yüksek dayanıma sahip titanyum iyon kaplama yöntemi ile üretilmektedir. Profix Q is square corner edge protection profile produced from 4301 grade stainless steel with offered 10 different surface colour options. All color options produced by PVD technologies with high resistance titanium ion covered .

Inox (Satinox), Dekorlu (Decor), Inox Parlak (Shine) yüzeyler 250 cm boyda üretilmektedir. / Surfaces 250 cm lenght. Ayna (Mirror), Altın (Satine Gold), Altın ayna (Gold), Bakır (Satine bronz), Bakır Ayna (Bronze mirror), Antrasit (Satine Anthracite), Antrasit ayna (Anthracite mirror) yüzeyler 244 cm boyda üretilmektedir. / surfaces 244 cm lenght. Maximum boy 300 cm üretilmektedir. / Profile can be produced up to 300 cm. Paket içi adeti: 50 ADET / Products per box. Belirtilen hammadde kalınlıkları 0,60 mm dir. Thickness is 0,60 mm.

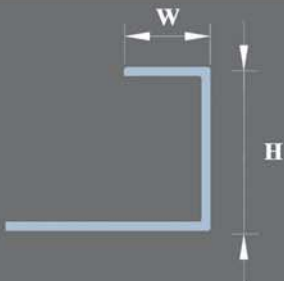

TEKNİK ÖLÇÜ TABLOSU

	8 mm	10 mm	12 mm	14 mm
W	8,5	8,5	8,5	8,5
H	10	12	14	16



Ebat size	Inox satinox	Dekorlu decor	Altın s gold	Bakır s bronze	Antrasit s. anthracite
8 mm	PD0825001 22,5 \$	PD0825011 31,0 \$	PD0824421 30,5 \$	PD0824431 42,0 \$	PD0824441 42,0 \$
10 mm	PD1025001 23,0 \$	PD1025011 31,5 \$	PD1024421 31,0 \$	PD1024431 42,5 \$	PD1024441 42,5 \$
12 mm	PD1225001 23,5 \$	PD1225011 32,0 \$	PD1224421 31,5 \$	PD1224431 43,0 \$	PD1224441 43,0 \$
14 mm	PD1425001 24,0 \$	PD1425011 32,5 \$	PD1424421 32,0 \$	PD1424431 43,5 \$	PD1424441 43,5 \$

Ebat size	Inox Ayna mirror	Inox Parlak shine	Altın Ayna gold	Bakır Ayna bronze	Antrasit Ayna anthracite
8 mm	PD0824400 26,5 \$	PD0825003 22,5 \$	PD0824420 30,5 \$	PD0824430 42,0 \$	PD0824440 42,0 \$
10 mm	PD1024400 27,0 \$	PD1025003 23,0 \$	PD1024420 31,0 \$	PD1024430 42,5 \$	PD1024440 42,5 \$
12 mm	PD1224400 27,5 \$	PD1225003 23,5 \$	PD1224420 31,5 \$	PD1224430 43,0 \$	PD1224440 43,0 \$
14 mm	PD1424400 28,0 \$	PD1425003 24,0 \$	PD1424420 32,0 \$	PD1424430 43,5 \$	PD1424440 43,5 \$

Profix D seramik , duvar kağıdı arasında kademeli geçiş sağlayan dekoratif görünümlü paslanmaz çelikten üretilen duvar kağıdı, kot farklılık profilidir.

Seramik ve duvar kağıdı geçişi için kullanılan 304 kalite paslanmaz çelikten üretilen duvar kağıdı kot farklılık profilidir. 10 farklı renk alternatifini ile üretilmektedir. Renkli ürünler PVD teknolojisi ile paslanmaz yüzeye yüksek dayanıma sahip titanyum iyon kaplama yöntemi ile üretilmektedir.

Profix D is transition and wall covering profile produced from 304 grade stainless steel with offered 10 different surface colour options . All colour options produced by PVD Technologies with high resistance titanium covered.

Inox (Satinox), Dekorlu (Decor), Inox Parlak (Shine) yüzeyler 250 cm boyda üretilmektedir. / Surfaces 250 cm length. Ayna (Mirror), Altın (Satine Gold), Altın ayna (Gold), Bakır (Satine bronze), Bakır Ayna (Bronze mirror), Antrasit (Satine Anthracite), Antrasit ayna (Anthracite mirror) yüzeyler 244 cm boyda üretilmektedir. / surfaces 244 cm length. Maximum boy 300 cm üretilmektedir. / Profile can be produced up to 300 cm. Paket içi adedi: 10 ADET / Products per box. Belirtilen hammadde kalınlıkları 0,80 mm dir, 0,60 mm için fiyat talep edilmelidir. Thickness is 0,80 mm. Should be request price for 0,60 mm alternatives.

TEKNİK ÖLÇÜ TABLOSU

	8 mm	10 mm	12 mm	14 mm
H	9,33	11,2	13,01	14,93

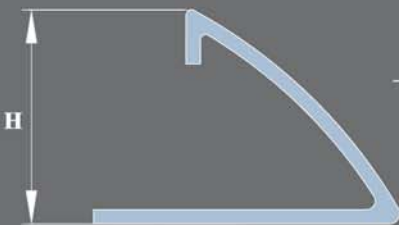



Ebat size	Inox satinox		Dekorlu decor		Altın s gold		Bakır s bronze		Antrasit s. anthracite	
8 mm	TD0825001	18,0 \$	TD0825011	24,8 \$	TD0824421	24,4 \$	TD0824431	33,6 \$	TD0824441	33,6 \$
10 mm	TD1025001	18,4 \$	TD1025011	25,2 \$	TD1024421	24,8 \$	TD1024431	34,0 \$	TD1024441	34,0 \$
12 mm	TD1225001	18,8 \$	TD1225011	25,6 \$	TD1224421	25,2 \$	TD1224431	34,4 \$	TD1224441	34,4 \$
14 mm	TD1425001	19,2 \$	TD1425011	26,0 \$	TD1424421	25,6 \$	TD1424431	34,8 \$	TD1424441	34,8 \$
Ebat size	Inox Ayna mirror		Inox Parlak shine		Altın Ayna gold		Bakır Ayna bronze		Antrasit Ayna anthracite	
8 mm	TD0824400	21,2 \$	TD0825003	18,0 \$	TD0824420	24,4 \$	TD0824430	33,6 \$	TD0824440	33,6 \$
10 mm	TD1024400	21,6 \$	TD1025003	18,4 \$	TD1024420	24,8 \$	TD1024430	34,0 \$	TD1024440	34,0 \$
12 mm	TD1224400	22,0 \$	TD1225003	18,8 \$	TD1224420	25,2 \$	TD1224430	34,4 \$	TD1224440	34,4 \$
14 mm	TD1424400	22,4 \$	TD1425003	19,2 \$	TD1424420	25,6 \$	TD1424430	34,8 \$	TD1424440	34,8 \$

Profix DE, seramik , duvar kağıdı arasında kademesiz geçiş sağlayan dekoratif görünümlü paslanmaz çelikten üretilen duvar kağıdı, kot farklılık profilidir.

Seramik ve duvar kağıdı geçişi için kullanılan 304 kalite paslanmaz çelikten üretilen duvar kağıdı kot farklılık profilidir. 10 farklı renk alternatifi ile üretilmektedir. Renkli ürünler PVD teknolojisi ile paslanmaz yüzeye yüksek dayanıma sahip titanyum iyon kaplama yöntemi ile üretilmektedir.

Profix DE is transition and wall covering profile produced from 4301 grade stainless steel with offered 10 different surface colour options . All colour options produced by PVD Technologies with high resistance titanium covered.

Inox (Satinox), Dekorlu (Decor), Inox Parlak (Shine) yüzeyler 250 cm boyda üretilmektedir. / Surfaces 250 cm length. Ayna (Mirror), Altın (Satine Gold), Altın ayna (Gold), Bakır (Satine bronze), Bakır Ayna (Bronze mirror), Antrasit (Satine Anthracite), Antrasit ayna (Anthracite mirror) yüzeyler 244 cm boyda üretilmektedir. / surfaces 244 cm length. Maximum boy 300 cm üretilmektedir. / Profile can be produced up to 300 cm. Paket içi adeti: 50 ADET / Products per box. Belirtilen hammadde kalınlıkları 0,60 mm dir. Thickness is 0,60 mm.

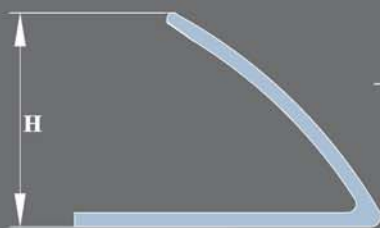

TEKNİK ÖLÇÜ TABLOSU

	8 mm	10 mm	12 mm	14 mm
H	9,33	11,2	13,01	14,93

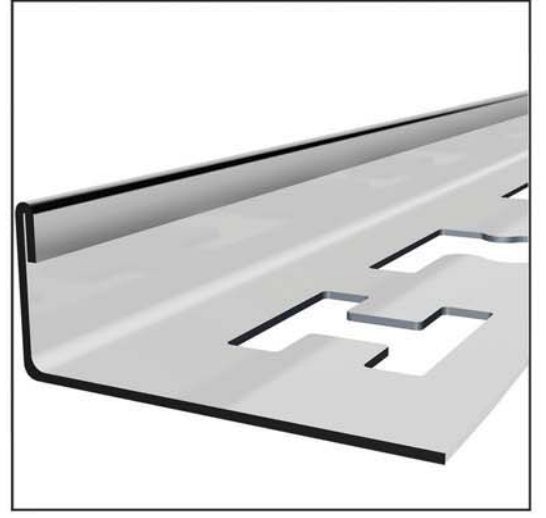

Ebat size	Inox satinox	Dekorlu decor	Altın s gold	Bakır s bronze	Antrasit s. anthracite
8 mm	PL0825001 19,5 \$	PL0825011 31,0 \$	PL0824421 27,0 \$	PL0824431 38,5 \$	PL0824441 38,5 \$
10 mm	PL1025001 20,0 \$	PL1025011 31,5 \$	PL1024421 27,5 \$	PL1024431 39,0 \$	PL1024441 39,0 \$
12 mm	PL1225001 20,5 \$	PL1225011 32,0 \$	PL1224421 28,0 \$	PL1224431 39,5 \$	PL1224441 39,5 \$
14 mm	PL1425001 21,0 \$	PL1425011 32,5 \$	PL1424421 28,5 \$	PL1424431 40,0 \$	PL1424441 40,0 \$
Ebat size	Inox Ayna mirror	Inox Parlak shine	Altın Ayna gold	Bakır Ayna bronze	Antrasit Ayna anthracite
8 mm	PL0824400 23,0 \$	PL0825003 19,5 \$	PL0824420 27,0 \$	PL0824430 38,5 \$	PL0824440 38,5 \$
10 mm	PL1024400 23,5 \$	PL1025003 20,0 \$	PL1024420 27,5 \$	PL1024430 39,0 \$	PL1024440 39,0 \$
12 mm	PL1224400 24,0 \$	PL1225003 20,5 \$	PL1224420 28,0 \$	PL1224430 39,5 \$	PL1224440 39,5 \$
14 mm	PL1424400 24,5 \$	PL1425003 21,0 \$	PL1424420 28,5 \$	PL1424430 40,0 \$	PL1424440 40,0 \$

Profix L seramik yüzeylerin dış köşelerini korumak amacıyla kullanılan dekoratif görünümlü paslanmaz çelikten üretilen L dış kenar bitiş profilidir. Seramik yüzeylerin dış köşelerini korumak için 304 kalite paslanmaz çelikten üretilen L dış kenar bitiş profilidir. 10 farklı renk alternatifi ile üretilmektedir. Renkli ürünler PVD teknolojisi ile paslanmaz yüzeye yüksek dayanıma sahip titanyum iyon kaplama yöntemi ile üretilmektedir. Profix L is shape outer edge profile produced from 4301 grade stainless steel with offered 10 different surface colour options. All colour options produced by PVD technologies with high resistance titanium covered.

Inox (Satinox), Dekorlu (Decor), Inox Parlak (Shine) yüzeyler 250 cm boyda üretilmektedir. / Surfaces 250 cm length. Ayna (Mirror), Altın (Satine Gold), Altın ayna (Gold), Bakır (Satine bronze), Bakır Ayna (Bronze mirror), Antrasit (Satine Anthracite), Antrasit ayna (Anthracite mirror) yüzeyler 244 cm boyda üretilmektedir. / surfaces 244 cm length. Maximum boy 300 cm üretilmektedir. / Profile can be produced up to 300 cm. Paket içi adedi: 25 ADET / Products per box. Belirtilen hammadde kalınlıkları 0,80 mm dir, 0,60 mm için fiyat talep edilmelidir. Thickness is 0,80 mm. Should be request price for 0,60 mm alternatives.

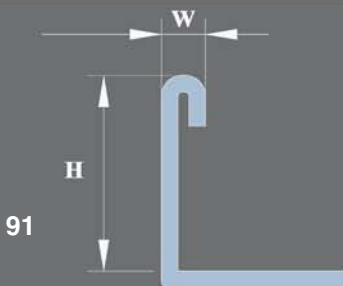

TEKNİK ÖLÇÜ TABLOSU

	8 mm	10 mm	12 mm	14 mm
W	2,13	2,58	3,03	3,48
H	9,5	11,5	13,5	15,5

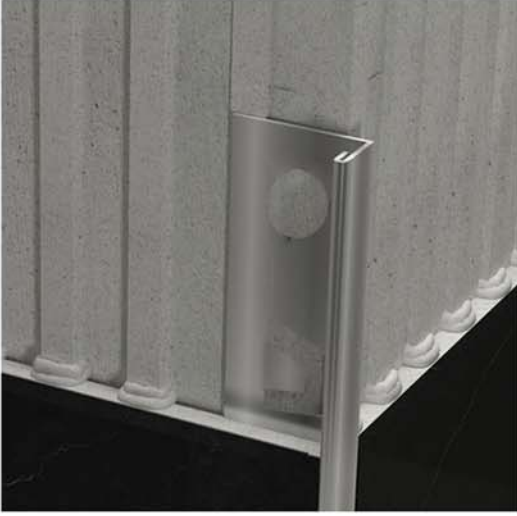

Ebat size	Inox satinox	Dekorlu decor	Altın s gold	Bakır s bronze	Antrasit s. anthracite
8 mm	TL0825001 15,6 \$	TL0825011 24,8 \$	TL0824421 21,6 \$	TL0824431 30,8 \$	TL0824441 30,8 \$
10 mm	TL1025001 16,0 \$	TL1025011 25,2 \$	TL1024421 22,0 \$	TL1024431 31,2 \$	TL1024441 31,2 \$
12 mm	TL1225001 16,4 \$	TL1225011 25,6 \$	TL1224421 22,4 \$	TL1224431 31,6 \$	TL1224441 31,6 \$
14 mm	TL1425001 16,8 \$	TL1425011 26,0 \$	TL1424421 22,8 \$	TL1424431 32,0 \$	TL1424441 32,0 \$

Ebat size	Inox Ayna mirror	Inox Parlak shine	Altın Ayna gold	Bakır Ayna bronze	Antrasit Ayna anthracite
8 mm	TL0824400 18,4 \$	TL0825003 15,6 \$	TL0824420 21,6 \$	TL0824430 30,8 \$	TL0824440 30,8 \$
10 mm	TL1024400 18,8 \$	TL1025003 16,0 \$	TL1024420 22,0 \$	TL1024430 31,2 \$	TL1024440 31,2 \$
12 mm	TL1224400 19,2 \$	TL1225003 16,4 \$	TL1224420 22,4 \$	TL1224430 31,6 \$	TL1224440 31,6 \$
14 mm	TL1424400 19,6 \$	TL1425003 16,8 \$	TL1424420 22,8 \$	TL1424430 32,0 \$	TL1424440 32,0 \$

Profix LE seramik yüzeylerin dış köşelerini korumak amacıyla kullanılan dekoratif görünümlü paslanmaz çelikten üretilen L dış kenar bitiş profilidir. Seramik yüzeylerin dış köşelerini korumak için 304 kalite paslanmaz çelikten üretilen L dış kenar bitiş profilidir. 10 farklı renk alternatifi ile üretilmektedir. Renkli ürünler PVD teknolojisi ile paslanmaz yüzeye yüksek dayanıma sahip titanyum iyon kaplama yöntemi ile üretilmektedir. Profix LE is shape outer edge profile produced from 4301 grade stainless steel with offered 10 different surface colour options. All colour options produced by PVD technologies with high resistance titanium covered.

Inox (Satinox), Dekorlu (Decor), Inox Parlak (Shine) yüzeyler 250 cm boyda üretilmektedir. / Surfaces 250 cm length. Ayna (Mirror), Altın (Satine Gold), Altın ayna (Gold), Bakır (Satine bronze), Bakır Ayna (Bronze mirror), Antrasit (Satine Anthracite), Antrasit ayna (Anthracite mirror) yüzeyler 244 cm boyda üretilmektedir. / surfaces 244 cm length. Maximum boy 300 cm üretilmektedir. / Profile can be produced up to 300 cm. Paket içi adeti: 50 ADET / Products per box. Belirtilen hammadde kalınlıkları 0,60 mm dir. Thickness is 0,60 mm.

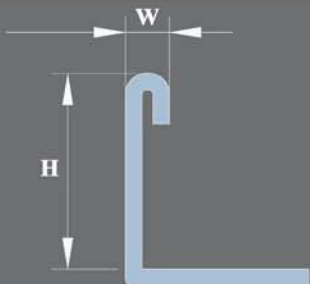

TEKNİK ÖLÇÜ TABLOSU

	8 mm	10 mm	12 mm	14 mm
W	2,13	2,58	3,03	3,48
H	9,5	11,5	13,5	15,5

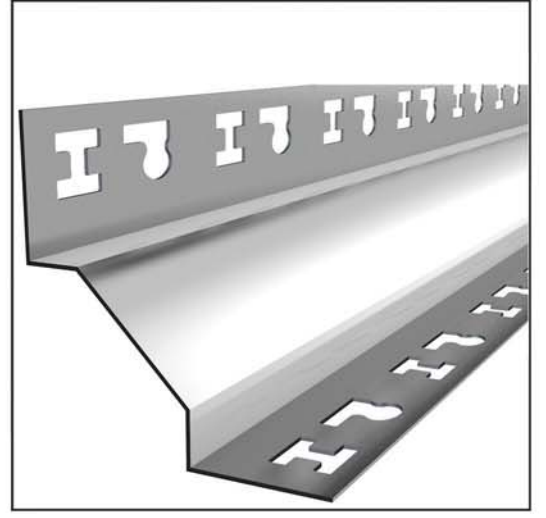

Ebat size	Inox satinox	Dekorlu decor	Altın s gold	Bakır s bronzze	Antrasit s. anthracite
9 mm	PU0925001 36,0 \$	PU0925011 55,0 \$	PU0924421 55,0 \$	PU0924431 70,0 \$	PU0924441 70,0 \$
11 mm	PU1125001 36,5 \$	PU1125011 55,5 \$	PU1124421 55,5 \$	PU1224431 70,5 \$	PU1224441 70,5 \$
16 mm	PU1625001 40,0 \$	PU1625011 70,0 \$	PU1624421 70,0 \$	PU1624431 85,0 \$	PU1624441 85,0 \$

Ebat size	Inox Ayna mirror	Inox Parlak shine	Altın Ayna gold	Bakır Ayna bronzze	Antrasit Ayna anthracite
9 mm	PU0924400 43,0 \$	PU0925003 36,0 \$	PU0924420 55,0 \$	PU0924430 70,0 \$	PU0924440 70,0 \$
11 mm	PU1124400 43,5 \$	PU1125003 36,5 \$	PU1124420 55,5 \$	PU1124430 70,5 \$	PU1124440 70,5 \$
16 mm	PU1624400 50,0 \$	PU1625003 40,0 \$	PU1624420 70,0 \$	PU1624430 85,0 \$	PU1624440 85,0 \$

Profix U seramik kaplamaların iç köşelerinde dekoratif ve temiz bir birleşim detayı oluşturan paslanmaz çelikten üretilen dahili iç köşe profilidir. Seramik yüzeylerin iç köşeleri için 304 kalite paslanmaz çelikten üretilen iç köşe profilidir. 10 farklı renk alternatifi ile üretilmektedir. Renkli ürünler PVD teknolojisi ile paslanmaz yüzeye yüksek dayanıma sahip titanyum iyon kaplama yöntemi ile üretilmektedir. Profix U is inner corner edge profile produced from 4301 grade stainless steel with offered 10 different surface colour options. All colour options produced by PVD technologies with high resistance titanium covered.

Inox (Satinox), Dekorlu (Decor), Inox Parlak (Shine) yüzeyler 250 cm boyda üretilmektedir. / Surfaces 250 cm length. Ayna (Mirror), Altın (Satine Gold), Altın ayna (Gold), Bakır (Satine bronze), Bakır Ayna (Bronze mirror), Antrasit (Satine Anthracite), Antrasit ayna (Anthracite mirror) yüzeyler 244 cm boyda üretilmektedir. / surfaces 244 cm length. Maximum boy 300 cm üretilmektedir. / Profile can be produced up to 300 cm. Paket içi adedi: 6 ADET / Products per box. Belirtilen hammadde kalınlıkları 0,80 mm dir, 0,60 mm için fiyat talep edilmelidir. Thickness is 0,80 mm. Should be request price for 0,60 mm alternatives.

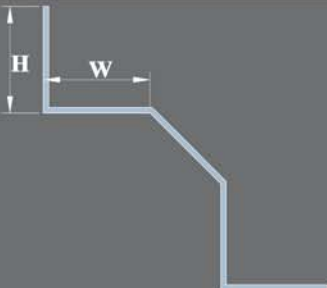

TEKNİK ÖLÇÜ TABLOSU

	9 mm	11 mm	16 mm
W	9	11	16
H	23	21	16

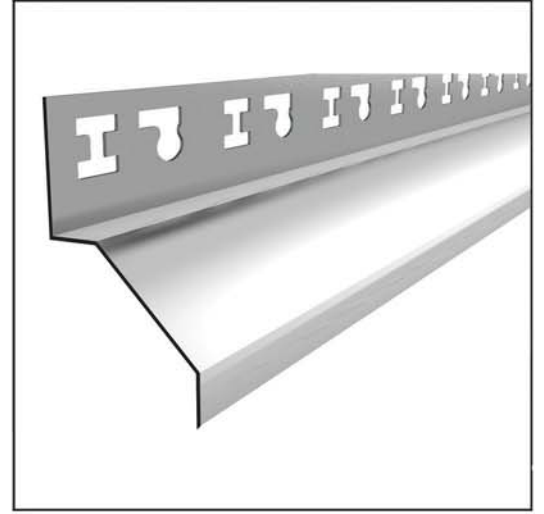
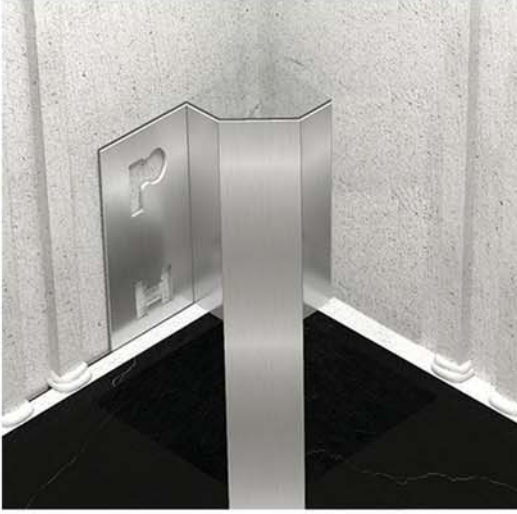

Ebat size	Inox satinox	Dekorlu decor	Altın s. gold	Bakır s. bronze	Antrasit s. anthracite
9 mm	PUT0925001 23,0 \$	PUT0924411 36,0 \$	PUT0924421 36,0 \$	PUT0924431 46,0 \$	PUT0924441 46,0 \$
11 mm	PUT1125001 23,5 \$	PUT1124411 36,5 \$	PUT1124421 36,5 \$	PUT1124431 46,5 \$	PUT1124441 46,5 \$
16 mm	PUT1625001 28,0 \$	PUT1624411 42,0 \$	PUT1624421 42,0 \$	PUT1624431 52,0 \$	PUT1624441 52,0 \$

Ebat size	Inox Ayna mirror	Inox Parlak shine	Altın Ayna gold	Bakır Ayna bronze	Antrasit Ayna anthracite
9 mm	PUT0924400 28,5 \$	PUT0925003 23,0 \$	PUT0924420 36,0 \$	PUT0924430 46,0 \$	PUT0924440 46,0 \$
11 mm	PUT1124400 29,0 \$	PUT1125003 23,5 \$	PUT1124420 36,5 \$	PUT1124430 46,5 \$	PUT1124440 46,5 \$
16 mm	PUT1624400 35,0 \$	PUT1625003 28,0 \$	PUT1624420 42,0 \$	PUT1624430 52,0 \$	PUT1624440 52,0 \$

Profix UT seramik kaplamaların iç köşelerinde dekoratif ve temiz bir birleşim detayı oluşturan paslanmaz çelikten üretilen dahili iç köşe profilidir. Seramik yüzeylerin iç köşeleri için 304 kalite paslanmaz çelikten üretilen iç köşe profilidir. 10 farklı renk alternatifi ile üretilmektedir. Renkli ürünler PVD teknolojisi ile paslanmaz yüzeye yüksek dayanıma sahip titanyum iyon kaplama yöntemi ile üretilmektedir. Profix UT is inner corner edge profile produced from 4301 grade stainless steel with offered 10 different surface colour options. All colour options produced by PVD technologies with high resistance titanium covered.

Inox (Satinox), Dekorlu (Decor), Inox Parlak (Shine) yüzeyler 250 cm boyda üretilmektedir. / Surfaces 250 cm length. Ayna (Mirror), Altın (Satine Gold), Altın ayna (Gold), Bakır (Satine bronze), Bakır Ayna (Bronze mirror), Antrasit (Satine Anthracite), Antrasit ayna (Anthracite mirror) yüzeyler 244 cm boyda üretilmektedir. / surfaces 244 cm length. Maximum boy 300 cm üretilmektedir. / Profile can be produced up to 300 cm. Paket içi adeti: 6 ADET / Products per box. Belirtilen hammadde kalınlıkları 0,80 mm dir, 0,60 mm için fiyat talep edilmelidir. Thickness is 0,80 mm. Should be request price for 0,60 mm alternatives.



TEKNİK ÖLÇÜ TABLOSU

	9 mm	11 mm	16 mm
W	9	11	16
H	23	21	16

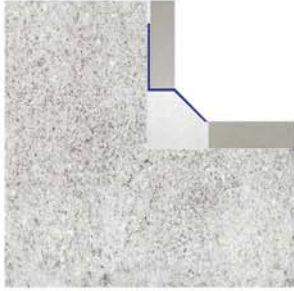
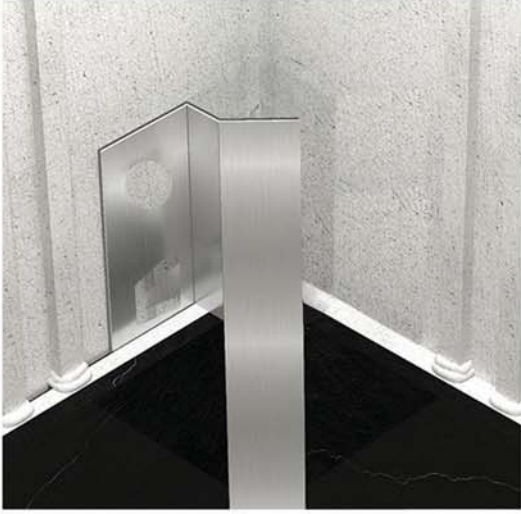

Ebat size	Inox satinox	Dekorlu decor	Altın s gold	Bakır s bronze	Antrasit s. anthracite
8 mm	TU0825001 18,0 \$	TU0825011 24,8 \$	TU0824421 24,4 \$	TU0824431 33,6 \$	TU0824441 33,6 \$
10 mm	TU1025001 18,4 \$	TU1025011 25,2 \$	TU1024421 24,8 \$	TU1024431 34,0 \$	TU1024441 34,0 \$
12 mm	TU1225001 18,8 \$	TU1225011 25,6 \$	TU1224421 25,2 \$	TU1224431 34,4 \$	TU1224441 34,4 \$
14 mm	TU1425001 19,2 \$	TU1425011 26,0 \$	TU1424421 25,6 \$	TU1424431 34,8 \$	TU1424441 34,8 \$
Ebat size	Inox Ayna mirror	Inox Parlak shine	Altın Ayna gold	Bakır Ayna bronze	Antrasit Ayna anthracite
8 mm	TU0824400 21,2 \$	TU0825003 18,0 \$	TU0824420 24,4 \$	TU0824430 33,6 \$	TU0824440 33,6 \$
10 mm	TU1024400 21,6 \$	TU1025003 18,4 \$	TU1024420 24,8 \$	TU1024430 34,0 \$	TU1024440 34,0 \$
12 mm	TU1224400 22,0 \$	TU1225003 18,8 \$	TU1224420 25,2 \$	TU1224430 34,4 \$	TU1224440 34,4 \$
14 mm	TU1424400 22,4 \$	TU1425003 19,2 \$	TU1424420 25,6 \$	TU1424430 34,8 \$	TU1424440 34,8 \$

Profix UE seramik kaplamaların iç köşelerinde dekoratif ve temiz bir birleşim detayı oluşturan paslanmaz çelikten üretilen dahili iç köşe profilidir. Seramik yüzeylerin iç köşeleri için 304 kalite paslanmaz çelikten üretilen iç köşe profilidir. 10 farklı renk alternatifi ile üretilmektedir. Renkli ürünler PVD teknolojisi ile paslanmaz yüzeye yüksek dayanıma sahip titanyum iyon kaplama yöntemi ile üretilmektedir. Profix UE is inner corner edge profile produced from 4301 grade stainless steel with offered 10 different surface colour options. All colour options produced by PVD technologies with high resistance titanium covered.

Inox (Satinox), Dekorlu (Decor), Inox Parlak (Shine) yüzeyler 250 cm boyda üretilmektedir. / Surfaces 250 cm length. Ayna (Mirror), Altın (Satine Gold), Altın ayna (Gold), Bakır (Satine bronze), Bakır Ayna (Bronze mirror), Antrasit (Satine Anthracite), Antrasit ayna (Anthracite mirror) yüzeyler 244 cm boyda üretilmektedir. / surfaces 244 cm length. Maximum boy 300 cm üretilmektedir. / Profile can be produced up to 300 cm. Paket içi adeti: 50 ADET / Products per box. Belirtilen hammadde kalınlıkları 0,60 mm dir. Thickness is 0,60 mm.

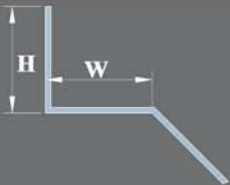

TEKNİK ÖLÇÜ TABLOSU

	8 mm	10 mm	12 mm	14 mm
W	15	15	15	10
H	8	10	12	14



Ebat size	Inox satinox	Dekorlu decor	Altın s gold	Bakır s bronze	Antrasit s. anthracite
20/10 mm	PC201025001 42 \$	PC201025011 73 \$	PC201024421 73 \$	PC201024431 93 \$	PC201024441 93 \$
20/12 mm	PC201225001 43 \$	PC201225011 74 \$	PC201224421 74 \$	PC201224431 94 \$	PC201224441 94 \$

Ebat size	Inox Ayna mirror	Inox Parlak shine	Altın Ayna gold	Bakır Ayna bronze	Antrasit Ayna anthracite
20/10 mm	PC201024400 60 \$	PC201025003 42 \$	PC201024420 73 \$	PC201024430 93 \$	PC201024440 93 \$
20/12 mm	PC201224400 61 \$	PC201225003 43 \$	PC201224420 74 \$	PC201224430 94 \$	PC201224440 94 \$

Profix C Seramik , mermer vb . kaplamaların dış köşelerinde dekoratif görünlü paslanmaz çelikten üretilen dahili dış köşe koruma profilidir. Mekanik darbelerin fazla olacağı düşünülen alanlarda (Endüstriyel mutfak,hastaneler ,kamu alanları ,fabrikalar vb...) dekoratif görünüm sağlayan dış köşe koruma profilidir.

Profix C is internal outer edge protection profile produced from 4301 grade stainless steel with offered 10 different surface color options . All colour options produced by PVD Technologies with high resistance titanium covered.

Inox (Satinox), Dekorlu (Decor), Inox Parlak (Shine) yüzeyler 250 cm boyda üretilmektedir. / Surfaces 250 cm lenght. Ayna (Mirror), Altın (Satine Gold), Altın ayna (Gold), Bakır (Satine bronze), Bakır Ayna (Bronze mirror),Antrasit (Satine Anthracite), Antrasit ayna (Anthracite mirror) yüzeyler 244 cm boyda üretilmektedir. / surfaces 244 cm lenght. Maximum boy 300 cm üretilmektedir. / Profile can be produced up to 300 cm. Paket içi adeti: 6 ADET / Products per box. Belirtilen hammadde kalınlıkları 0,80 mm dir, 0,60 mm için fiyat talep edilmelidir. Thickness is 0,80 mm. Should be request price for 0,60 mm alternatives.

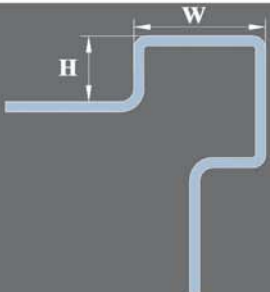

TEKNİK ÖLÇÜ TABLOSU

	10 mm	12 mm
W	20	20
H	10	12



Ebat size	Inox satinox	Dekorlu decor	Altın s gold	Bakır s bronze	Antrasit s. anthracite
8 mm	PB450825001 29,0 \$	PB450824411 38,5 \$	PB450824421 48,0 \$	PB450824431 57,0 \$	PB450824441 57,5 \$
10 mm	PB451025001 29,5 \$	PB451024411 39,0 \$	PB451024421 48,5 \$	PB451024431 58,0 \$	PB451024441 58,0 \$
12 mm	PB451225001 30,0 \$	PB451224411 39,5 \$	PB451224421 49,0 \$	PB451224431 58,5 \$	PB451224441 58,5 \$
14 mm	PB451425001 30,5 \$	PB451424411 40,0 \$	PB451424421 49,5 \$	PB451424431 59,0 \$	PB451424441 59,0 \$

Ebat size	Inox Ayna mirror	Inox Parlak shine	Altın Ayna gold	Bakır Ayna bronze	Antrasit Ayna anthracite
8 mm	PB450824400 38,5 \$	PB450825003 29,0 \$	PB450824420 48,0 \$	PB450824430 57,5 \$	PB450824440 57,5 \$
10 mm	PB451024400 39,0 \$	PB451025003 29,5 \$	PB451024420 48,5 \$	PB451024430 58,0 \$	PB451024440 58,0 \$
12 mm	PB451224400 39,5 \$	PB451225003 30,0 \$	PB451224420 49,0 \$	PB451224430 58,5 \$	PB451224440 58,5 \$
14 mm	PB451424400 40,0 \$	PB451425003 30,5 \$	PB451424420 49,5 \$	PB451424430 59,0 \$	PB451424440 59,0 \$

Profix 45 seramik kaplamalarda 45 derece dış köşelerinde kullanılan paslanmaz çelikten üretilen açılı köşe koruma profilidir.

Seramik kaplamalarda 45 derece dış köşelerinde kullanılan paslanmaz çelikten üretilen açılı köşe koruma profilidir. 10 farklı renk alternatifi ile üretilmektedir. Renkli ürünler PVD teknolojisi ile paslanmaz yüzeye yüksek dayanıma sahip titanyum iyon kaplama yöntemi ile üretilmektedir.

Profix 45 is corner edge protection profile produced from 4301 grade stainless steel with offered 10 different surface colour options. All colour options produced by PVD technologies with high resistance titanium covered.

Inox (Satinox), Dekorlu (Decor), Inox Parlak (Shine) yüzeyler 250 cm boyda üretilmektedir. / Surfaces 250 cm length. Ayna (Mirror), Altın (Satine Gold), Altın ayna (Gold), Bakır (Satine bronze), Bakır Ayna (Bronze mirror), Antrasit (Satine Anthracite), Antrasit ayna (Anthracite mirror) yüzeyler 244 cm boyda üretilmektedir. / surfaces 244 cm length. Maximum boy 300 cm üretilmektedir. / Profile can be produced up to 300 cm. Paket içi adeti: 10 ADET / Products per box. Belirtilen hammadde kalınlıkları 0,80 mm dir, 0,60 mm için fiyat talep edilmelidir. Thickness is 0,80 mm. Should be request price for 0,60 mm alternatives.

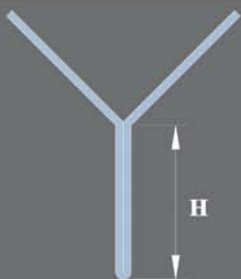

TEKNİK ÖLÇÜ TABLOSU

	8 mm	10 mm	12 mm	14 mm
H	10	12	14	16

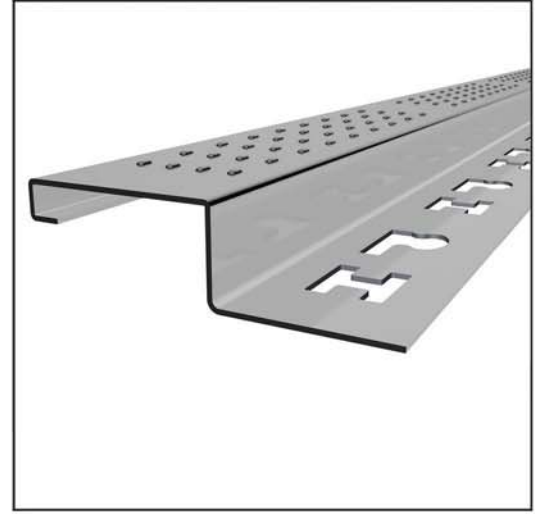

Ebat size	Inox satinox		Dekorlu decor	
11 mm	PS1125001	46 \$	PS1125011	55 \$
13 mm	PS1325001	46 \$	PS1325011	55 \$
25 mm	PS2525001	46 \$	PS2525011	55 \$

Ebat size	Inox Parlak Shine	
11 mm	PS1125003	46 \$
13 mm	PS1325003	46 \$
25 mm	PS2525003	46 \$

Profix S merdiven basamaklarının kenarları için kullanılan emniyetli ve kaymayı engelleyici özel yüzeyi ile paslanmaz çelikten üretilen dahili merdiven köşe koruma profilidir. Kaymayı önleyen özel yüzeyi ile 304 kalite paslanmaz çelikten üretilen merdiven profilidir. 10 farklı renk alternatifini ile üretilmektedir. Renkli ürünler PVD teknolojisi ile paslanmaz yüzeye yüksek dayanıma sahip titanyum iyon kaplama yöntemi ile üretilmektedir. Profix S is internal stairs edge protection profile produced from 4301 grade stainless steel with offered 10 different surface colour options. All colour options produced by PVD technologies with high resistance titanium ion covered.

Inox (Satinox), Dekorlu (Decor), Inox Parlak (Shine) yüzeyler 250 cm boyda üretilmektedir. / Surfaces 250 cm length. Ayna (Mirror), Altın (Satine Gold), Altın ayna (Gold), Bakır (Satine bronze), Bakır Ayna (Bronze mirror), Antrasit (Satine Antracite), Antrasit ayna (Antracite mirror) yüzeyler 244 cm boyda üretilmektedir. / surfaces 244 cm length. Maximum boy 300 cm üretilmektedir. / Profile can be produced up to 300 cm. Paket içi adeti: 6 ADET / Products per box. Belirtilen hammadde kalınlıkları 0,80 mm dir, 0,60 mm için fiyat talep edilmelidir. Thickness is 0,80 mm. Should be request price for 0,60 mm alternatives.

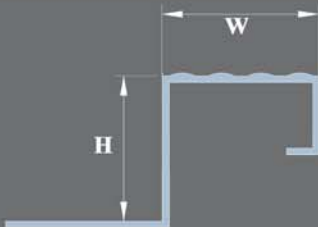

TEKNİK ÖLÇÜ TABLOSU

	10 mm	12 mm	14 mm
W	30	30	30
H	11,5	13,5	15,5

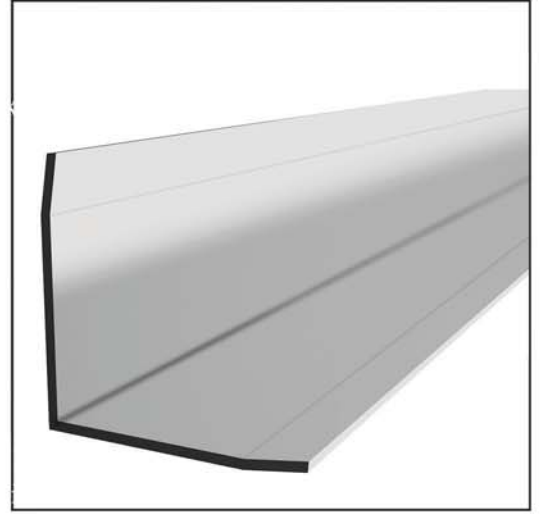

Ebat size	Inox satinox	Dekorlu decor	Altın s gold	Bakır s bronze	Antrasit s. anthracite
15 mm	PR1525001 16,5 \$	PR1525011 30 \$	PR1524421 30 \$	PR1524431 40 \$	PR1524441 40 \$
32 mm	PR3225001 24,5 \$	PR3225011 42 \$	PR3224421 42 \$	PR3224431 47 \$	PR3224441 47 \$

Ebat size	Inox Ayna mirror	Inox Parlak shine	Altın Ayna gold	Bakır Ayna bronze	Antrasit Ayna anthracite
15 mm	PR1524400 22 \$	PR1525003 16,5 \$	PR1524420 30 \$	PR1524430 40 \$	PR1524440 40 \$
32 mm	PR3224400 30 \$	PR3225003 24,5 \$	PR3224420 42 \$	PR3224430 47 \$	PR3224440 47 \$

Profix R seramik ve farklı kaplama malzemelerinin dış köşelerine uygulama sonrası yapıştırarak uygulanabilen hem dekoratif hem de mekanik dayanım sağlayan paslanmaz çelikten üretilen harici dış köşe koruma profilidir.

Seramik ve farklı kaplama malzemelerinin dış köşeleri için 304 kalite paslanmaz çelikten üretilen dekoratif görümlü harici dış köşe koruma profilidir. 10 farklı renk alternatifi ile üretilmektedir. Renkli ürünler PVD teknolojisi ile paslanmaz yüzeye yüksek dayanıma sahip titanyum iyon kaplama yöntemi ile üretilmektedir.

Profix R is internal outer corner edge protection profile produced from 4301 grade stainless steel with offered 10 different surface color options. All color options produced by PVD Technologies with high resistance titanium ion covered .

Inox (Satinox), Dekorlu (Decor), Inox Parlak (Shine) yüzeyler 250 cm boyda üretilmektedir. / Surfaces 250 cm length. Ayna (Mirror), Altın (Satine Gold), Altın ayna (Gold), Bakır (Satine bronze), Bakır Ayna (Bronze mirror), Antrasit (Satine Anthracite), Antrasit ayna (Anthracite mirror) yüzeyler 244 cm boyda üretilmektedir. / surfaces 244 cm length. Maximum boy 300 cm üretilmektedir. / Profile can be produced up to 300 cm. Paket içi adedi: 10 ADET / Products per box. Belirtilen hammadde kalınlıkları 0,80 mm dir, 0,60 mm için fiyat talep edilmelidir. Thickness is 0,80 mm. Should be request price for 0,60 mm alternatives.

TEKNİK ÖLÇÜ TABLOSU



	15 mm	32 mm
H	15	32



Ebat size	Inox satinox	Dekorlu decor	Altın s gold	Bakır s bronze	Antrasit s. anthracite
15 mm	PV1525001	16,5 \$	30 \$	30 \$	40 \$
32 mm	PV3225001	24,5 \$	42 \$	42 \$	47 \$

Ebat size	Inox Ayna mirror	Inox Parlak shine	Altın Ayna gold	Bakır Ayna bronze	Antrasit Ayna anthracite
15 mm	PV1524400	22 \$	16,5 \$	30 \$	40 \$
32 mm	PV3224400	30 \$	24,5 \$	42 \$	47 \$

Profix V seramik ve farklı kaplama malzemelerinin iç köşelerinde dekoratif ve temiz birleşim detayı oluşturmak amacıyla kullanılan paslanmaz çelikten üretilen harici iç köşe koruma profilidir.

Seramik ve farklı kaplama malzemelerinin iç köşeleri için 304 kalite paslanmaz çelikten üretilen dekoratif görünümlü harici iç köşe koruma profilidir. 10 farklı renk alternatifini ile üretilmektedir. Renkli ürünler PVD teknolojisi ile paslanmaz yüzeye yüksek dayanıma sahip titanyum iyon kaplama yöntemi ile üretilmektedir.

Profix V is internal outer corner edge protection profile produced from 4301 grade stainless steel with offered 10 different surface colour options. All colour options produced by PVD technologies with high resistance titanium ion covered.

Inox (Satinox), Dekorlu (Decor), Inox Parlak (Shine) yüzeyler 250 cm boyda üretilmektedir. / Surfaces 250 cm length. Ayna (Mirror), Altın (Satine Gold), Altın ayna (Gold), Bakır (Satine bronze), Bakır Ayna (Bronze mirror), Antrasit (Satine Anthracite), Antrasit ayna (Anthracite mirror) yüzeyler 244 cm boyda üretilmektedir. / surfaces 244 cm length. Maximum boy 300 cm üretilmektedir. / Profile can be produced up to 300 cm. Paket içi adeti: 6 ADET / Products per box. Belirtilen hammadde kalınlıkları 0,80 mm dir, 0,60 mm için fiyat talep edilmelidir. Thickness is 0,80 mm. Should be request price for 0,60 mm alternatives.

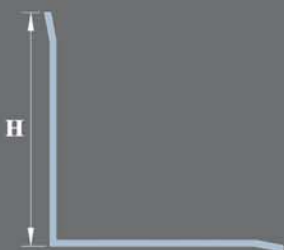

TEKNİK ÖLÇÜ TABLOSU

	15 mm	32 mm
H	15	32

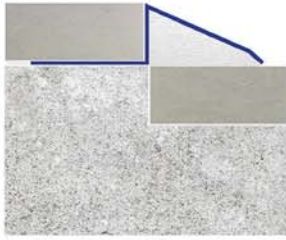

Ebat size	Inox satinox	Dekorlu decor	Altın s gold	Bakır s bronze	Antrasit s. anthracite
8 mm	PK0825001 30 \$	PK0825011 35 \$	PK0824421 55 \$	PK0824431 75 \$	PK0824441 67,0 \$
10 mm	PK1025001 30 \$	PK1025011 35 \$	PK1024421 55 \$	PK1024431 75 \$	PK1024441 67,0 \$
12 mm	PK1225001 30 \$	PK1225011 35 \$	PK1224421 55 \$	PK1224431 75 \$	PK1224441 67,0 \$
14 mm	PK1425001 42 \$	PK1425011 49 \$	PK1424421 77 \$	PK1424431 105 \$	PK1424441 93,8 \$
20 mm	PK2025001 42 \$	PK2025011 49 \$	PK2024421 77 \$	PK2024431 105 \$	PK2024441 93,8 \$

Ebat size	Inox Ayna mirror	Inox Parlak shine	Altın Ayna gold	Bakır Ayna bronze	Antrasit Ayna anthracite
8 mm	PK0824400 45 \$	PK0825003 30 \$	PK0824420 55 \$	PK0824430 75 \$	PK0824440 67,0 \$
10 mm	PK1024400 45 \$	PK1025003 30 \$	PK1024420 55 \$	PK1024430 75 \$	PK1024440 67,0 \$
12 mm	PK1224400 45 \$	PK1225003 30 \$	PK1224420 55 \$	PK1224430 75 \$	PK1224440 67,0 \$
14 mm	PK1424400 63 \$	PK1425003 42 \$	PK1424420 77 \$	PK1424430 105 \$	PK1424440 93,8 \$
20 mm	PK2024400 63 \$	PK2025003 42 \$	PK2024420 77 \$	PK2024430 105 \$	PK2024440 93,8 \$

Profix Kot K seramik, mermer ve tüm kaplamalarda kademesiz geçişi sağlayan dekoratif görünümlü paslanmaz çelikten üretilen kot farklılık profilidir. Seramik ,mermer ve tüm kaplamalarda kademesiz geçişi sağlayan 304 kalite paslanmaz çelikten üretilen kot farklılık profilidir. 10 farklı renk alternatifini ile üretilmektedir. Renkli ürünler PVD teknolojisi ile paslanmaz yüzeye yüksek dayanıma sahip titanyum iyon kaplama yöntemi ile üretilmektedir. Profix KOT K is stepless transition profile produced from 4301 grade stainless steel with offered 10 different surface color options. All colour options produced by PVD Technologies with high resistance titanium covered .

Inox (Satinox), Dekorlu (Decor), Inox Parlak (Shine) yüzeyler 250 cm boyda üretilmektedir. / Surfaces 250 cm length. Ayna (Mirror), Altın (Satine Gold), Altın ayna (Gold), Bakır (Satine bronze), Bakır Ayna (Bronze mirror), Antrasit (Satine Anthracite), Antrasit ayna (Anthracite mirror) yüzeyler 244 cm boyda üretilmektedir. / surfaces 244 cm length. Maximum boy 300 cm üretilmektedir. / Profile can be produced up to 300 cm. Paket içi adeti: 8 ADET / Products per box. Belirtilen hammadde kalınlıkları 0,80 mm dir, 0,60 mm için fiyat talep edilmelidir. Thickness is 0,80 mm. Should be request price for 0,60 mm alternatives.

TEKNİK ÖLÇÜ TABLOSU

	08 mm	10 mm	12 mm	14 mm	20 mm
W	30	30	30	30	30
H	9,5	11,5	13,5	15,5	21,5



Ebat size	Inox satinox	Dekorlu decor	Altın s gold	Bakır s bronze	Antrasit s. anthracite
8 mm	PZ0825001 30 \$	PZ0825011 35 \$	PZ0824421 55 \$	PZ0824431 75 \$	PZ0824441 67,0 \$
10 mm	PZ1025001 30 \$	PZ1025011 35 \$	PZ1024421 55 \$	PZ1024431 75 \$	PZ1024441 67,0 \$
12 mm	PZ1225001 30 \$	PZ1225011 35 \$	PZ1224421 55 \$	PZ1224431 75 \$	PZ1224441 67,0 \$
14 mm	PZ1425001 42 \$	PZ1425011 49 \$	PZ1424421 77 \$	PZ1424431 105 \$	PZ1424441 93,8 \$
20 mm	PZ2025001 42 \$	PZ2025011 49 \$	PZ2024421 77 \$	PZ2024431 105 \$	PZ2024441 93,8 \$



Ebat size	Inox Ayna mirror	Inox Parlak shine	Altın Ayna gold	Bakır Ayna bronze	Antrasit Ayna anthracite
8 mm	PZ0824400 45 \$	PZ0825003 30 \$	PZ0824420 55 \$	PZ0824430 75 \$	PZ0824440 67,0 \$
10 mm	PZ1024400 45 \$	PZ1025003 30 \$	PZ1024420 55 \$	PZ1024430 75 \$	PZ1024440 67,0 \$
12 mm	PZ1224400 45 \$	PZ1225003 30 \$	PZ1224420 55 \$	PZ1224430 75 \$	PZ1224440 67,0 \$
14 mm	PZ1424400 63 \$	PZ1425003 42 \$	PZ1424420 77 \$	PZ1424430 105 \$	PZ1424440 93,8 \$
20 mm	PZ2024400 63 \$	PZ2025003 42 \$	PZ2024420 77 \$	PZ2024430 105 \$	PZ2024440 93,8 \$

Profix Kot Z seramik, mermer ve tüm kaplamalarda kademesiz geçişi sağlayan dekoratif görünümlü paslanmaz çelikten üretilen kot farklılık profildir. Seramik, mermer ve tüm kaplamalarda kademesiz geçişi sağlayan 304 kalite paslanmaz çelikten üretilen kot farklılık profildir. 10 farklı renk alternatifini ile üretilmektedir. Renkli ürünler PVD teknolojisi ile paslanmaz yüzeye yüksek dayanıma sahip titanyum iyon kaplama yöntemi ile üretilmektedir.

Profix KOT Z is stepless transition profile produced from 4301 grade stainless steel with offered 10 different surface color options. All colour options produced by PVD Technologies with high resistance titanium covered.

Inox (Satinox), Dekorlu (Decor), Inox Parlak (Shine) yüzeyler 250 cm boyda üretilmektedir. / Surfaces 250 cm length. Ayna (Mirror), Altın (Satine Gold), Altın ayna (Gold), Bakır (Satine bronze), Bakır Ayna (Bronze mirror), Antrasit (Satine Anthracite), Antrasit ayna (Anthracite mirror) yüzeyler 244 cm boyda üretilmektedir. / surfaces 244 cm length. Maximum boy 300 cm üretilmektedir. / Profile can be produced up to 300 cm. Paket içi adeti: 6 ADET / Products per box. Belirtilen hammadde kalınlıkları 0,80 mm dir, 0,60 mm için fiyat talep edilmelidir. Thickness is 0,80 mm. Should be request price for 0,60 mm alternatives.

TEKNİK ÖLÇÜ TABLOSU

	08 mm	10 mm	12 mm	14 mm	20 mm
W	30	30	30	30	30
H	9,5	11,5	13,5	15,5	21,5



Ebat size	Inox satinox	Dekorlu decor	Altın s gold	Bakır s bronze	Antrasit s. anthracite
8 mm	PN0825001 30 \$	PN0825011 35 \$	PN0824421 55 \$	PN0824431 75 \$	PN0824441 67 \$
10 mm	PN1025001 30 \$	PN1025011 35 \$	PN1024421 55 \$	PN1024431 75 \$	PN1024441 67 \$
12 mm	PN1225001 30 \$	PN1225011 35 \$	PN1224421 55 \$	PN1224431 75 \$	PN1224441 67 \$
14 mm	PN1425001 42 \$	PN1425011 49 \$	PN1424421 77 \$	PN1424431 105 \$	PN1424441 94 \$
20 mm	PN2025001 42 \$	PN2025011 49 \$	PN2024421 77 \$	PN2024431 105 \$	PN2024441 94 \$

Ebat size	Inox Ayna mirror	Inox Parlak shine	Altın Ayna gold	Bakır Ayna bronze	Antrasit Ayna anthracite
8 mm	PN0824400 45 \$	PN0825003 30 \$	PN0824420 55 \$	PN0824430 75 \$	PN0824440 67 \$
10 mm	PN1024400 45 \$	PN1025003 30 \$	PN1024420 55 \$	PN1024430 75 \$	PN1024440 67 \$
12 mm	PN1224400 45 \$	PN1225003 30 \$	PN1224420 55 \$	PN1224430 75 \$	PN1224440 67 \$
14 mm	PN1424400 63 \$	PN1425003 42 \$	PN1424420 77 \$	PN1424430 105 \$	PN1424440 94 \$
20 mm	PN2024400 63 \$	PN2025003 42 \$	PN2024420 77 \$	PN2024430 105 \$	PN2024440 94 \$

Profix Kot N seramik, mermer ve tüm kaplamalarda farklı yüksekliklerdeki zemin yüzeyleri arasında geçişi sağlayan dekoratif görünümlü paslanmaz çelikten üretilen kot farklılık profilidir.

Seramik, mermer ve tüm kaplamalarda farklı kotlardaki geçişi sağlayan 304 kalite paslanmaz çelikten üretilen kot farklılık profilidir. 10 farklı renk alternatifi ile üretilmektedir. Renkli ürünler PVD teknolojisi ile paslanmaz yüzeye yüksek dayanıma sahip titanyum iyon kaplama yöntemi ile üretilmektedir.

Profix KOT N is stepless transition profile produced from 430l grade stainless steel with offered 10 different surface colour options. All color options produced by PVD Technologies with high resistance titanium covered.

Inox (Satinox), Dekorlu (Decor), Inox Parlak (Shine) yüzeyler 250 cm boyda üretilmektedir. / Surfaces 250 cm length. Ayna (Mirror), Altın (Satine Gold), Altın ayna (Gold), Bakır (Satine bronze), Bakır Ayna (Bronze mirror), Antrasit (Satine Anthracite), Antrasit ayna (Anthracite mirror) yüzeyler 244 cm boyda üretilmektedir. / surfaces 244 cm length. Maximum boy 300 cm üretilmektedir. / Profile can be produced up to 300 cm. Paket içi adedi: 8 ADET / Products per box. Belirtilen hammadde kalınlıkları 0,80 mm dir, 0,60 mm için fiyat talep edilmelidir. Thickness is 0,80 mm. Should be request price for 0,60 mm alternatives.

TEKNİK ÖLÇÜ TABLOSU

	08 mm	10 mm	12 mm	14 mm	20 mm
W	30	30	30	30	30
H	9,5	11,5	13,5	15,5	21,5

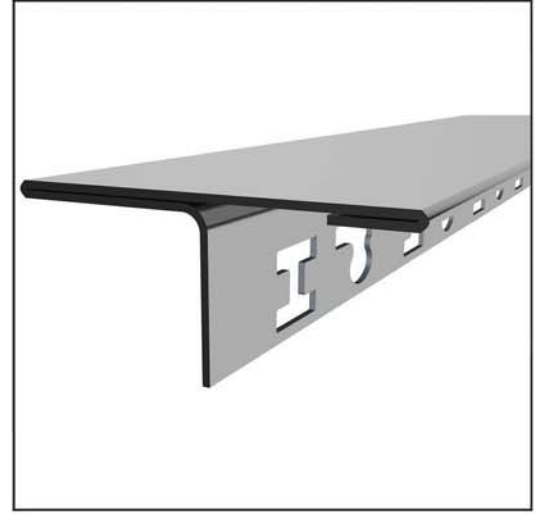

Ebat size	Inox satinox	Altın s gold	Bakır Bronze	Antrasit s. anthracite
15 mm	PT1525001	26 \$ PT1524421	43 \$ PT1524431	57 \$ PT1524441
25 mm	PT2525001	34 \$ PT2524421	52 \$ PT2524431	65 \$ PT2524441

Ebat size	Inox Ayna mirror	Inox Parlak shine	Altın Ayna gold	Bakır Ayna bronze	Antrasit Ayna anthracite
15 mm	PT1524400	39 \$ PT1525003	26 \$ PT1524420	43 \$ PT1524430	57 \$ PT1524440
25 mm	PT2524400	46 \$ PT2525003	34 \$ PT2524420	52 \$ PT2524430	65 \$ PT2524440



Ebat size	Inox satinox	Altın s gold	Bakır Bronze	Antrasit s. anthracite
10 mm	PT1025001	39 \$ PT1024421	58 \$ PT1024431	75 \$ PT1024441
12 mm	PT1225001	39 \$ PT1224421	58 \$ PT1224431	75 \$ PT1224441
14 mm	PT1425001	39 \$ PT1424421	58 \$ PT1424431	75 \$ PT1424441

Ebat size	Inox Ayna mirror	Inox Parlak shine	Altın Ayna gold	Bakır Ayna bronze	Antrasit Ayna anthracite
10 mm	PT1024400	53 \$ PT1025003	39 \$ PT1024420	58 \$ PT1024430	75 \$ PT1024440
12 mm	PT1224400	53 \$ PT1225003	39 \$ PT1224420	58 \$ PT1224430	75 \$ PT1224440
14 mm	PT1424400	53 \$ PT1425003	39 \$ PT1424420	58 \$ PT1424430	75 \$ PT1424440

Inox (Satinox), Dekorlu (Decor), Inox Parlak (Shine) yüzeyler 250 cm boyda üretilmektedir. / Surfaces 250 cm lenght. Ayna (Mirror), Altın (Satine Gold), Altın ayna (Gold), Bakır (Satine bronze), Bakır Ayna (Bronze mirror), Antrasit (Satine Anthracite), Antrasit ayna (Anthracite mirror) yüzeyler 244 cm boyda üretilmektedir. / surfaces 244 cm lenght. Maximum boy 300 cm üretilmektedir. / Profile can be produced up to 300 cm. Paket içi adeti: 6 ADET / Products per box. Belirtilen hammadde kalınlıkları 0,80 mm dir, 0,60 mm için fiyat talep edilmelidir. Thickness is 0,80 mm. Should be request price for 0,60 mm alternatives.

TEKNİK ÖLÇÜ TABLOSU

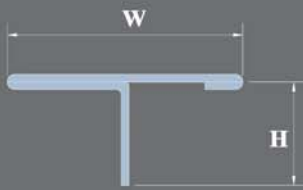

	15 mm	25 mm
W	15	25
H	13	11



Ebat size	Inox satinox	
8 mm	PG0825001	62,5 \$
10 mm	PG1025001	65,0 \$
12 mm	PG1225001	67,5 \$
14 mm	PG1425001	70,0 \$

Profix G seramik kaplamalarda kullanılan her türlü hareket derzlerine uygun paslanmaz çelikten üretilen dilatasyon profilidir.

Seramik ,mermer ve tüm kaplamalarda farklı kotlardaki geçişi sağlayan 304 kalite paslanmaz çelikten üretilen kot farklılık profilidir.10 farklı renk alternatifi ile üretilmektedir. Renkli ürünler PVD teknolojisi ile paslanmaz yüzeye yüksek dayanıma sahip titanyum iyon kaplama yöntemi ile üretilmektedir.

Profix G is dilatation profile produced from 4301 grade stainless steel with offered 10 different surface colour options . All color options produced by PVD Technologies with high resistance titanium covered .

Inox (Satinox), Dekorlu (Decor), Inox Parlak (Shine) yüzeyler 250 cm boyda üretilmektedir. / Surfaces 250 cm length. Ayna (Mirror), Altın (Satine Gold), Altın ayna (Gold), Bakır (Satine bronze), Bakır Ayna (Bronze mirror),Antrasit (Satine Antracite), Antrasit ayna (Antracite mirror) yüzeyler 244 cm boyda üretilmektedir. / surfaces 244 cm length. Maximum boy 300 cm üretilmektedir. / Profile can be produced up to 300 cm. Paket içi adeti: 10 ADET / Products per box. Belirtilen hammadde kalınlıkları 0,80 mm dir, 0,60 mm için fiyat talep edilmelidir. Thickness is 0,80 mm. Should be request price for 0,60 mm alternatives.

TEKNİK ÖLÇÜ TABLOSU

	8 mm	10 mm	12 mm	14 mm
W	24,5	23,5	19,5	14,93
H	12	14	22	14,93

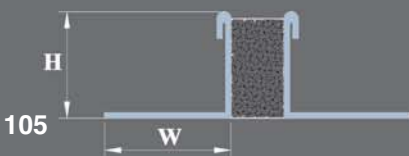

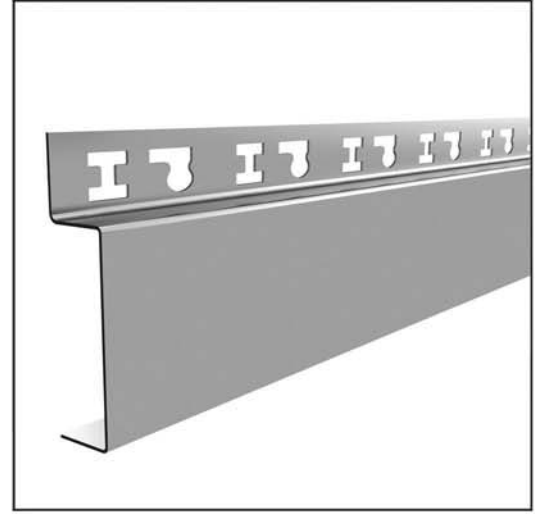

Ebat size	Inox satinox	Dekorlu decor	Altın s gold	Bakır s bronz	Antrasit s. anthracite
40/ 08 mm	PE1400825001	45 \$ PE1400825011	51 \$ PE1400824421	82 \$ PE1400824431	110 \$ PE1400824441
40/ 10 mm	PE1401025001	45 \$ PE1401025011	51 \$ PE1401024421	82 \$ PE1401024431	110 \$ PE1401024441
40/ 12 mm	PE1401225001	45 \$ PE1401225011	51 \$ PE1401224421	82 \$ PE1401224431	110 \$ PE1401224441
40/ 14 mm	PE1401425001	45 \$ PE1401425011	51 \$ PE1401424421	82 \$ PE1401424431	110 \$ PE1401424441

Ebat size	Inox Ayna mirror	Inox Parlak shine	Altın Ayna gold	Bakır Ayna bronz	Antrasit Ayna anthracite
40/ 08 mm	PE1400824403	58 \$ PE1400825003	45 \$ PE1400824420	82 \$ PE1400824430	110 \$ PE1400824440
40/ 10 mm	PE1401024403	58 \$ PE1401025003	45 \$ PE1401024420	82 \$ PE1401024430	110 \$ PE1401024440
40/ 12 mm	PE1401224403	58 \$ PE1401224403	45 \$ PE1401224420	82 \$ PE1401224430	110 \$ PE1401224440
40/ 14 mm	PE1401424403	58 \$ PE1401424403	45 \$ PE1401424420	82 \$ PE1401424430	110 \$ PE1401424440

Ebat size	Inox satinox	Dekorlu decor	Altın s gold	Bakır s bronz	Antrasit s. anthracite
70/ 08 mm	PE1700825001	55 \$ PE1700825011	70 \$ PE1700824421	101 \$ PE1700824431	120 \$ PE1700824441
70/ 10 mm	PE1701025001	55 \$ PE1701025011	70 \$ PE1701024421	101 \$ PE1701024431	120 \$ PE1701024441
70/ 12 mm	PE1701225001	55 \$ PE1701225011	70 \$ PE1701224421	101 \$ PE1701224431	120 \$ PE1701224441
70/ 14 mm	PE1701425001	55 \$ PE1701425011	70 \$ PE1701424421	101 \$ PE1701424431	120 \$ PE1701424441

Ebat size	Inox Ayna mirror	Inox Parlak shine	Altın Ayna gold	Bakır Ayna bronz	Antrasit Ayna anthracite
70/ 08 mm	PE1700824400	70 \$ PE1700825003	55 \$ PE1700824420	101 \$ PE1700824430	120 \$ PE1700824440
70/ 10 mm	PE1701024400	70 \$ PE1701025003	55 \$ PE1701024420	101 \$ PE1701024430	120 \$ PE1701024440
70/ 12 mm	PE1701224400	70 \$ PE1701225003	55 \$ PE1701224420	101 \$ PE1701224430	120 \$ PE1701224440
70/ 14 mm	PE1701424400	70 \$ PE1701425003	55 \$ PE1701424420	101 \$ PE1701424430	120 \$ PE1701424440

Profix E1 seramik,mermer ve tüm kaplamalarda paslanmaz çelikten üretilen dekoratif görünümlü dahili süpürgelik profildir. Seramik,mermer ve tüm kaplamalarda süpürgelik olarak kullanılan 304 kalite paslanmaz çelikten üretilen profildir.10 farklı renk alternatifi ile üretilmektedir. Renkli ürünler PVD teknolojisi ile paslanmaz yüzeye yüksek dayanıma sahip titanyum iyon kaplama yöntemi ile üretilmektedir.

Profix E1 is baseboard profile produced from 4301 grade stainless steel with offered 10 different surface color options. All colour options produced by PVD Technologies with high resistance titanium covered .

Inox (Satinox), Dekorlu (Decor), Inox Parlak (Shine) yüzeyler 250 cm boyda üretilmektedir. / Surfaces 250 cm lenght. Ayna (Mirror), Altın (Satine Gold), Altın ayna (Gold), Bakır (Satine bronz), Bakır Ayna (Bronze mirror),Antrasit (Satine Anthracite), Antrasit ayna (Anthracite mirror) yüzeyler 244 cm boyda üretilmektedir. / surfaces 244 cm lenght. Maximum boy 300 cm üretilmektedir. / Profile can be produced up to 300 cm. Paket içi adeti: 6 ADET / Products per box. Belirtilen hammadde kalınlıkları 0,80 mm dir, 0,60 mm için fiyat talep edilmelidir. Thickness is 0,80 mm. Should be request price for 0,60 mm alternatives.



TEKNİK ÖLÇÜ TABLOSU

	40/8 mm	40/10 mm	40/12 mm	40/14 mm	70/8 mm	70/10 mm	70/12 mm	70/14 mm
W	8	10	12	14	8	10	12	14
H	40	40	40	40	70	70	70	70

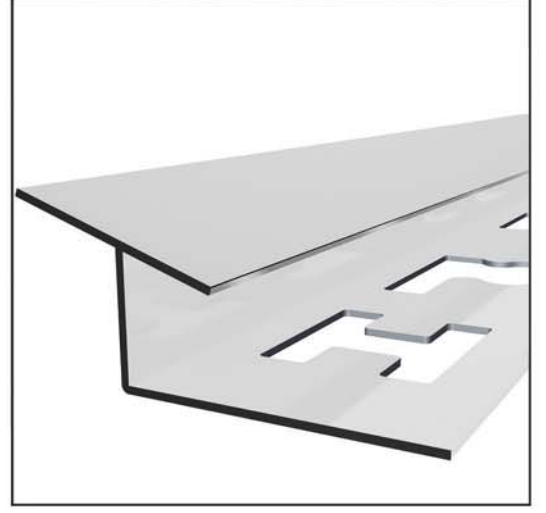

Ebat size	Inox satinox	Dekorlu decor	Altın s gold	Bakır s bronze	Antrasit s anthracite
8 mm	PY0825001 39 \$	PY0825011 53 \$	PY0824421 58 \$	PY0824431 75 \$	PY0824441 75 \$
10 mm	PY1025001 39 \$	PY1025011 53 \$	PY1024421 58 \$	PY1024431 75 \$	PY1024441 75 \$
12 mm	PY1225001 39 \$	PY1225011 53 \$	PY1224421 58 \$	PY1224431 75 \$	PY1224441 75 \$
14 mm	PY1425001 39 \$	PY1425011 53 \$	PY1424421 58 \$	PY1424431 75 \$	PY1424441 75 \$

Ebat size	Inox Ayna mirror	Inox Parlak shine	Altın Ayna gold	Bakır Ayna bronze	Antrasit Ayna anthracite
8 mm	PY0824400 53 \$	PY0825003 39 \$	PY0824420 58 \$	PY0824430 75 \$	PY0824440 75 \$
10 mm	PY1024400 53 \$	PY1025003 39 \$	PY1024420 58 \$	PY1024430 75 \$	PY1024440 75 \$
12 mm	PY1224400 53 \$	PY1225003 39 \$	PY1224420 58 \$	PY1224430 75 \$	PY1224440 75 \$
14 mm	PY1424400 53 \$	PY1425003 39 \$	PY1424420 58 \$	PY1424430 75 \$	PY1424440 75 \$

Profix Y seramik yüzeylerin iç köşe ve birleşim noktaları için kullanılan dahili paslanmaz çelikten üretilen dekoratif görünümlü dahili iç köşe koruma profilidir.

Profix G is dilatation profile produced from 4301 grade stainless steel with offered 10 different surface colour options . All color options produced by PVD Technologies with high resistance titanium covered .

Profix Y is inner corner edge profile produced from 4301 grade stainless steel with offered 10 different surface colour options.All colour options produced by PVD technologies with high resistance titanium covered.

Inox (Satinox), Dekorlu (Decor), Inox Parlak (Shine) yüzeyler 250 cm boyda üretilmektedir. / Surfaces 250 cm lenght. Ayna (Mirror), Altın (Satine Gold), Altın ayna (Gold), Bakır (Satine bronze), Bakır Ayna (Bronze mirror),Antrasit (Satine Anthracite), Antrasit ayna (Anthracite mirror) yüzeyler 244 cm boyda üretilmektedir. / surfaces 244 cm lenght. Maximum boy 300 cm üretilmektedir. / Profile can be produced up to 300 cm. Paket içi adeti: 10 ADET / Products per box. Belirtilen hammadde kalınlıkları 0,80 mm dir, 0,60 mm için fiyat talep edilmelidir. Thickness is 0,80 mm. Should be request price for 0,60 mm alternatives.

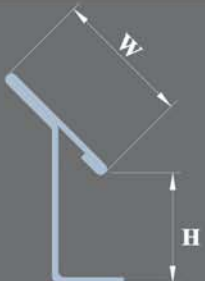

TEKNİK ÖLÇÜ TABLOSU

	8 mm	10 mm	12 mm	14 mm
W	20	20	20	20
H	10	12	14	16

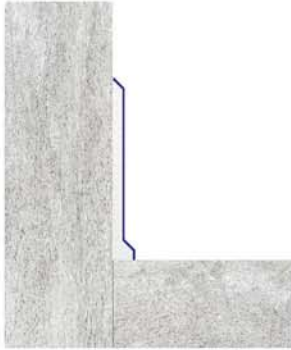
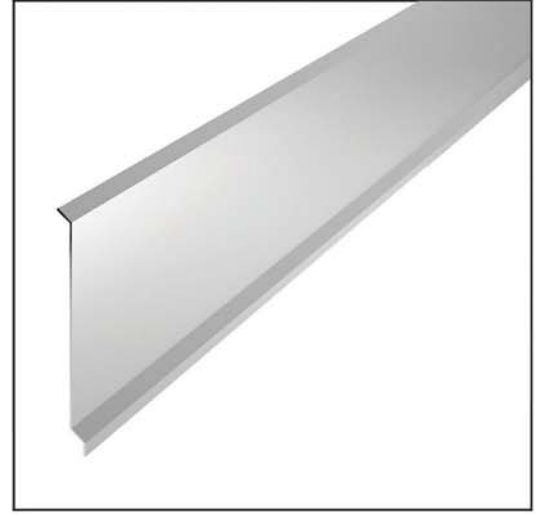

Ebat size	Inox satinox	
70 mm	PE27025001	45 \$

Ebat size	Inox Parlak shine	
70 mm	PE27025003	45 \$

Profix E2 seramik , mermer ve tüm kaplamalarda paslanmaz çelikten üretilen dekoratif görünümlü harici süpürelilik profildir.Seramik ,mermer ve tüm kaplamalarda süpürelilik olarak kullanılan 304 kalite paslanmaz çelikten üretilen profildir.10 farklı renk alternatifini ile üretilmektedir. Renkli ürünler PVD teknolojisi ile paslanmaz yüzeye yüksek dayanıma sahip titanyum iyon kaplama yöntemi ile üretilmektedir. Profix E2 is baseboard profile produced from 4301 grade stainless steel with offered 10 different surface colour options. All colour options produced by PVD technologies with high resistance titanium covered .

Inox (Satinox), Dekorlu (Decor), Inox Parlak (Shine) yüzeyler 250 cm boyda üretilmektedir. / Surfaces 250 cm lenght. Ayna (Mirror), Altın (Satine Gold), Altın ayna (Gold), Bakır (Satine bronze), Bakır Ayna (Bronze mirror),Antrasit (Satine Antracite), Antrasit ayna (Antracite mirror) yüzeyler 244 cm boyda üretilmektedir. / surfaces 244 cm lenght. Maximum boy 300 cm üretilmektedir. / Profile can be produced up to 300 cm. Paket içi adedi: 6 ADET / Products per box. Belirtilen hammadde kalınlıkları 0,80 mm dir, 0,60 mm için fiyat talep edilmelidir. Thickness is 0,80 mm. Should be request price for 0,60 mm alternatives.



TEKNİK ÖLÇÜ TABLOSU

70 mm	
H	70



Ebat size	Inox satinox	Dekorlu decor	Altın s gold	Bakır s bronze	Antrasit s. anthracite
40/ 08 mm	PE3400824401	45 \$ PE3400825011	51 \$ PE3400824421	82 \$ PE3400824431	110 \$ PE3400824441
40/ 10 mm	PE3401024401	45 \$ PE3401025011	51 \$ PE3401024421	82 \$ PE3401024431	110 \$ PE3401024441
40/ 12 mm	PE3401224401	45 \$ PE3401225011	51 \$ PE3401224421	82 \$ PE3401224431	110 \$ PE3401224441
40/ 14 mm	PE3401424401	45 \$ PE3401425011	51 \$ PE3401424421	82 \$ PE3401424431	110 \$ PE3401424441

Ebat size	Inox Ayna mirror	Inox Parlak shine	Altın Ayna gold	Bakır Ayna bronze	Antrasit Ayna anthracite
40/ 08 mm	PE3400824400	58 \$ PE3400825003	45 \$ PE3400824420	82 \$ PE3400824430	110 \$ PE3400824440
40/ 10 mm	PE3401024400	58 \$ PE3401025003	45 \$ PE3401024420	82 \$ PE3401024430	110 \$ PE3401024440
40/ 12 mm	PE3401224400	58 \$ PE3401224403	45 \$ PE3401224420	82 \$ PE3401224430	110 \$ PE3401224440
40/ 14 mm	PE3401424400	58 \$ PE3401424403	45 \$ PE3401424420	82 \$ PE3401424430	110 \$ PE3401424440

Ebat size	Inox satinox	Dekorlu decor	Altın s gold	Bakır s bronze	Antrasit s. anthracite
70/ 08 mm	PE3700825001	55 \$ PE3700825011	70 \$ PE3700824421	101 \$ PE3700824431	120 \$ PE3700824441
70/ 10 mm	PE3701025001	55 \$ PE3701025011	70 \$ PE3701024421	101 \$ PE3701024431	120 \$ PE3701024441
70/ 12 mm	PE3701225001	55 \$ PE3701225011	70 \$ PE3701224421	101 \$ PE3701224431	120 \$ PE3701224441
70/ 14 mm	PE3701425001	55 \$ PE3701425011	70 \$ PE3701424421	101 \$ PE3701424431	120 \$ PE3701424441

Ebat size	Inox Ayna mirror	Inox Parlak shine	Altın Ayna gold	Bakır Ayna bronze	Antrasit Ayna anthracite
70/ 08 mm	PE3700824400	70 \$ PE3700825003	55 \$ PE3700824420	101 \$ PE3700824430	120 \$ PE3700824440
70/ 10 mm	PE3701024400	70 \$ PE3701025003	55 \$ PE3701024420	101 \$ PE3701024430	120 \$ PE3701024440
70/ 12 mm	PE3701224400	70 \$ PE3701225003	55 \$ PE3701224420	101 \$ PE3701224430	120 \$ PE3701224440
70/ 14 mm	PE3701424400	70 \$ PE3701425003	55 \$ PE3701424420	101 \$ PE3701424430	120 \$ PE3701424440

Profix E3 seramik, mermer ve tüm kaplamalarda paslanmaz çelikten üretilen dekoratif görümlü süpürgelik profilidir. Seramik ,mermer ve tüm kaplamalarda süpürgelik olarak kullanılan 304 kalite paslanmaz çelikten üretilen profildir.10 farklı renk alternatifi ile üretilmektedir. Renkli ürünler PVD teknolojisi ile paslanmaz yüzeye yüksek dayanıma sahip titanyum iyon kaplama yöntemi ile üretilmektedir.

Profix E3 is baseboard profile produced from 4301 grade stainless steel with offered 10 different surface colour options. All colour options produced by PVD technologies with high resistance titanium covered .



TEKNİK ÖLÇÜ TABLOSU

	40/8 mm	40/10 mm	40/12 mm	40/14 mm	70/8 mm	70/10 mm	70/12 mm	70/14 mm
W	8	10	12	14	8	10	12	14
H	40	40	40	40	70	70	70	70



Ebat size	Inox satinox	
10 mm	PE41025001	55 \$
12 mm	PE41225001	56 \$
20 mm	PE42025001	57 \$

Ebat size	Inox Parlak shine	
10 mm	PE41025003	55 \$
12 mm	PE41225003	56 \$
20 mm	PE42025003	57 \$

Profix E4 seramik, mermer ve tüm kaplamalarda damlalık olarak kullanılan dekoratif görünümlü paslanmaz çelikten üretilen dahili damlalık profilidir. Seramik, mermer ve tüm kaplamalarda damlalık kullanılan 304 kalite paslanmaz çelikten üretilen damlalık profilidir. 10 farklı renk alternatifi ile üretilmektedir. Renkli ürünler PVD teknolojisi ile paslanmaz yüzeye yüksek dayanıma sahip titanyum iyon kaplama yöntemi ile üretilmektedir. Profix E4 is internal drip profile produced from 4301 grade stainless steel with offered 10 different surface colour options. All colour options produced by PVD technologies with high resistance titanium covered.

Inox (Satinox), Dekorlu (Decor), Inox Parlak (Shine) yüzeyler 250 cm boyda üretilmektedir. / Surfaces 250 cm length. Ayna (Mirror), Altın (Satin Gold), Altın ayna (Gold), Bakır (Satin bronze), Bakır Ayna (Bronze mirror), Antrasit (Satin Antracite), Antrasit ayna (Antracite mirror) yüzeyler 244 cm boyda üretilmektedir. / surfaces 244 cm length. Maximum boy 300 cm üretilmektedir. / Profile can be produced up to 300 cm. Paket içi adeti: 6 ADET / Products per box. Belirtilen hammadde kalınlıkları 0,80 mm dir, 0,60 mm için fiyat talep edilmelidir. Thickness is 0,80 mm. Should be request price for 0,60 mm alternatives.

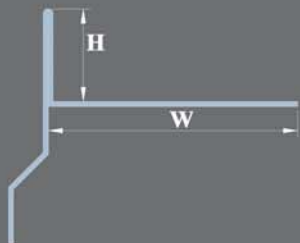

TEKNİK ÖLÇÜ TABLOSU

	10 mm	12 mm	14 mm
W	47	45	43
H	12	14	16

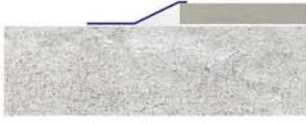

Ebat size	Inox satinox	
8 mm	PKA0825001	23,0 \$
10 mm	PKA1025001	23,5 \$
12 mm	PKA1225001	24,0 \$
14 mm	PKA1425001	24,5 \$
20 mm	PKA2025001	27,0 \$

Ebat size	Inox Parlak shine	
8 mm	PKA0825003	23,0 \$
10 mm	PKA1025003	23,5 \$
12 mm	PKA1225003	24,0 \$
14 mm	PKA1425003	24,5 \$
20 mm	PKA2025003	27,0 \$

Profix Kot A seramik, mermer ve tüm kaplamalarda farklı yüksekliklerdeki zemin yüzeyleri arasında geçişi sağlayan dekoratif görünümlü paslanmaz çelikten üretilen kot farklılık profilidir.

Seramik, mermer ve tüm kaplamalarda farklı kotlardaki geçişi sağlayan 304 kalite paslanmaz çelikten üretilen kot farklılık profilidir. 10 farklı renk alternatifi ile üretilmektedir. Renkli ürünler PVD teknolojisi ile paslanmaz yüzeye yüksek dayanıma sahip titanyum iyon kaplama yöntemi ile üretilmektedir.

Profix KOT A is stepless transition profile produced from 4301 grade stainless steel with offered 10 different surface colour options. All colour options produced by PVD technologies with high resistance titanium covered.

Inox (Satinox), Dekorlu (Decor), Inox Parlak (Shine) yüzeyler 250 cm boyda üretilmektedir. / Surfaces 250 cm length. Ayna (Mirror), Altın (Satine Gold), Altın ayna (Gold), Bakır (Satine bronze), Bakır Ayna (Bronze mirror), Antrasit (Satine Antracite), Antrasit ayna (Antracite mirror) yüzeyler 244 cm boyda üretilmektedir. / surfaces 244 cm length. Maximum boy 300 cm üretilmektedir. / Profile can be produced up to 300 cm. Paket içi adeti: 8 ADET / Products per box. Belirtilen hammadde kalınlıkları 0,80 mm dir, 0,60 mm için fiyat talep edilmelidir. Thickness is 0,80 mm. Should be request price for 0,60 mm alternatives.

TEKNİK ÖLÇÜ TABLOSU

		8 mm	10 mm	12 mm	14 mm
111	W	6	6	6	6
	H	10	12	14	16

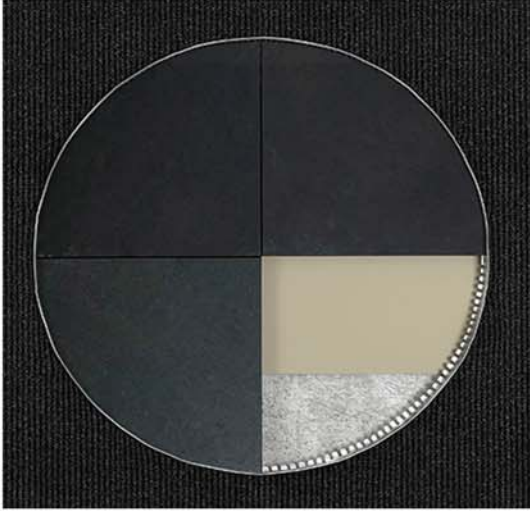

Ebat size	Inox satinox	Altın s gold	Bakır s bronze	Antrasit s. anthracite
8 mm	PLR0825001 26,0 \$	PLR0824421 44,5 \$	PLR0824431 54,5 \$	PLR0824441 54,5 \$
10 mm	PLR1025001 26,5 \$	PLR1024421 45,0 \$	PLR1024431 55,0 \$	PLR1024441 55,0 \$
12 mm	PLR1225001 27,0 \$	PLR1224421 45,5 \$	PLR1224431 55,5 \$	PLR1224441 55,5 \$
14 mm	PLR1425001 27,5 \$	PLR1424421 46,0 \$	PLR1424431 56,0 \$	PLR1424441 56,0 \$



Ebat size	Inox Ayna mirror	Inox Parlak shine	Altın Ayna gold	Bakır Ayna bronze	Antrasit Ayna anthracite
8 mm	PLR0824400 35,0 \$	PLR0825003 26,0 \$	PLR0824420 44,5 \$	PLR0824430 54,5 \$	PLR0824440 54,5 \$
10 mm	PLR1024400 35,5 \$	PLR1025003 26,5 \$	PLR1024420 45,0 \$	PLR1024430 55,0 \$	PLR1024440 55,0 \$
12 mm	PLR1224400 36,0 \$	PLR1225003 27,0 \$	PLR1224420 45,5 \$	PLR1224430 55,5 \$	PLR1224440 55,5 \$
14 mm	PLR1424400 36,5 \$	PLR1425003 27,5 \$	PLR1424420 46,0 \$	PLR1424430 56,0 \$	PLR1424440 56,0 \$

Profix LR seramik yüzeylerin dış köşelerini korumak amacıyla kullanılan dekoratif görünümlü paslanmaz çelikten üretilen LR dış kenar bitiş profilidir. Seramik yüzeylerin dış köşelerini korumak için 304 kalite paslanmaz çelikten üretilen LR dış kenar bitiş profilidir. 10 farklı renk alternatifi ile üretilmektedir. Renkli ürünler PVD teknolojisi ile paslanmaz yüzeye yüksek dayanıma sahip titanyum iyon kaplama yöntemi ile üretilmektedir. Profix LR is shape outer edge profile produced from 4301 grade stainless steel with offered 10 different surface colour options. All colour options produced by PVD technologies with high resistance titanium covered.

Inox (Satinox), Dekorlu (Decor), Inox Parlak (Shine) yüzeyler 250 cm boyda üretilmektedir. / Surfaces 250 cm lenght. Ayna (Mirror), Altın (Satine Gold), Altın ayna (Gold), Bakır (Satine bronze), Bakır Ayna (Bronze mirror), Antrasit (Satine Anthracite), Antrasit ayna (Anthracite mirror) yüzeyler 244 cm boyda üretilmektedir. / surfaces 244 cm lenght. Maximum boy 300 cm üretilmektedir. / Profile can be produced up to 300 cm. Paket içi adedi: 6 ADET / Products per box. Belirtilen hammadde kalınlıkları 0,80 mm dir, 0,60 mm için fiyat talep edilmelidir. Thickness is 0,80 mm. Should be request price for 0,60 mm alternatives.

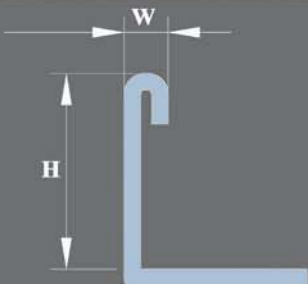

TEKNİK ÖLÇÜ TABLOSU

	8 mm	10 mm	12 mm	14 mm
W	2,13	2,58	3,03	3,48
H	9,5	11,5	13,5	15,5

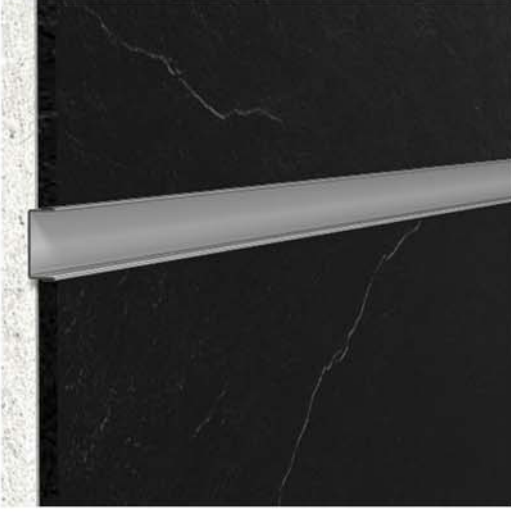

Ebat size	Inox satinox	Dekorlu decor	Altın s gold	Bakır s bronze	Antrasit s. anthracite
15 mm	PB1525001 23 \$	PB1525011 29 \$	PB1524421 35 \$	PB1524431 40 \$	PB1524441 40 \$
23 mm	PB2325001 26 \$	PB2325011 32 \$	PB2324421 38 \$	PB2324431 43 \$	PB2322441 43 \$
30 mm	PB3025001 28 \$	PB3025011 34 \$	PB3024421 40 \$	PB3024431 46 \$	PB3024441 46 \$

Ebat size	Inox Ayna mirror	Inox Parlak shine	Altın Ayna gold	Bakır Ayna bronze	Antrasit Ayna anthracite
15 mm	PB1524400 29 \$	PB1525003 23 \$	PB1524420 35 \$	PB1524430 40 \$	PB1524440 40 \$
23 mm	PB2324400 32 \$	PB2325003 26 \$	PB2324420 38 \$	PB2324430 43 \$	PB2324440 43 \$
30 mm	PB3024400 34 \$	PB3025003 28 \$	PB3024420 40 \$	PB3024430 46 \$	PB3024440 46 \$

Profix B seramik,mermer ve tüm kaplamalarda bordür olarak kullanılan dekoratif görünümlü paslanmaz çelikten üretilen fuga profilidir. Seramik ,mermer ve tüm kaplamalarda bordür amaçlı kullanılan 304 kalite paslanmaz çelikten üretilen fuga profilidir.10 farklı renk alternatif ile üretilmektedir. Renkli ürünler PVD teknolojisi ile paslanmaz yüzeye yüksek dayanıma sahip titanyum iyon kaplama yöntemi ile üretilmektedir. Profix B is fuga profile produced from 4301 grade stainless stell with offered 10 differnt surface colour options.All colour options produced by PVD technologies with high residance titanium covered .

Inox (Satinox), Dekorlu (Decor), Inox Parlak (Shine) yüzeyler 250 cm boyda üretilmektedir. / Surfaces 250 cm lenght. Ayna (Mirror), Altın (Satine Gold), Altın ayna (Gold), Bakır (Satine bronze), Bakır Ayna (Bronze mirror),Antrasit (Satine Anthracite), Antrasit ayna (Anthracite mirror) yüzeyler 244 cm boyda üretilmektedir. / surfaces 244 cm lenght. Maximum boy 300 cm üretilmektedir. / Profile can be produced up to 300 cm. Paket içi adeti: 10 ADET / Products per box. Belirtilen hammadde kalınlıkları 0,80 mm dir, 0,60 mm için fiyat talep edilmelidir. Thickness is 0,80 mm. Should be request price for 0,60 mm alternatives.

TEKNİK ÖLÇÜ TABLOSU

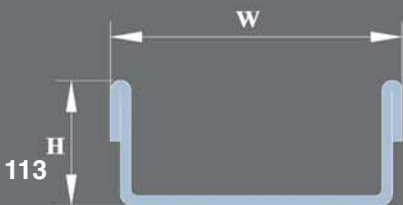

	15 mm	23 mm	30 mm
W	15	23	30
H	10	10	10



Ebat size	Inox satinox	Dekorlu decor	Altın s gold	Bakır s bronze	Antrasit s. anthracite
8 mm	PBB0825001 22,5 \$	PBB0825011 31,0 \$	PBB0824421 30,5 \$	PBB0824431 42,0 \$	PBB0824441 42,0 \$
10 mm	PBB1025001 23,0 \$	PBB1025011 31,5 \$	PBB1024421 31,0 \$	PBB1024431 42,5 \$	PBB1024441 42,5 \$
12 mm	PBB1225001 23,5 \$	PBB1225011 32,0 \$	PBB1224421 31,5 \$	PBB1224431 43,0 \$	PBB1224441 43,0 \$
14 mm	PBB1425001 24,0 \$	PBB1425011 32,5 \$	PBB1424421 32,0 \$	PBB1424431 43,5 \$	PBB1424441 43,5 \$

Ebat size	Inox Ayna mirror	Inox Parlak shine	Altın Ayna gold	Bakır Ayna bronze	Antrasit Ayna anthracite
8 mm	PBB0824400 26,5 \$	PBB0825003 22,5 \$	PBB0824420 30,5 \$	PBB0824430 42,0 \$	PBB0824440 42,0 \$
10 mm	PBB1024400 27,0 \$	PBB1025003 23,0 \$	PBB1024420 31,0 \$	PBB1024430 42,5 \$	PBB1024440 42,5 \$
12 mm	PBB1224400 27,5 \$	PBB1225003 23,5 \$	PBB1224420 31,5 \$	PBB1224430 43,0 \$	PBB1224440 43,0 \$
14 mm	PBB1424400 28,0 \$	PBB1425003 24,0 \$	PBB1424420 32,0 \$	PBB1424430 43,5 \$	PBB1424440 43,5 \$

Profix BB seramik, mermer ve tüm kaplamalarda bordür olarak kullanılan dekoratif görünümlü paslanmaz çelikten üretilen fuga profilidir. Seramik, mermer ve tüm kaplamalarda bordür amaçlı kullanılan 304 kalite paslanmaz çelikten üretilen fuga profilidir. 10 farklı renk alternatifi ile üretilmektedir. Renkli ürünler PVD teknolojisi ile paslanmaz yüzeye yüksek dayanıma sahip titanyum iyon kaplama yöntemi ile üretilmektedir. Profix BB is Fuga profile produced from 4301 grade stainless steel with offered 10 different surface colour options. All colour options produced by PVD technologies with high resistance titanium covered.

Inox (Satinox), Dekorlu (Decor), Inox Parlak (Shine) yüzeyler 250 cm boyda üretilmektedir. / Surfaces 250 cm lenght. Ayna (Mirror), Altın (Satine Gold), Altın ayna (Gold), Bakır (Satine bronze), Bakır Ayna (Bronze mirror), Antrasit (Satine Anthracite), Antrasit ayna (Anthracite mirror) yüzeyler 244 cm boyda üretilmektedir. / surfaces 244 cm lenght. Maximum boy 300 cm üretilmektedir. / Profile can be produced up to 300 cm. Paket içi adeti: 6 ADET / Products per box. Belirtilen hammadde kalınlıkları 0,80 mm dir, 0,60 mm için fiyat talep edilmelidir. Thickness is 0,80 mm. Should be request price for 0,60 mm alternatives.

		TEKNİK ÖLÇÜ TABLOSU			
		8 mm	10 mm	12 mm	14 mm
H	W	5,5	5,5	5,5	5,5
	H	10	12	14	16

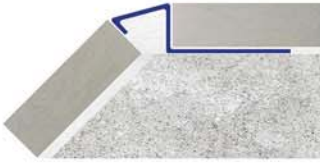

Ebat size	Inox satinox	Dekorlu decor	Altın s gold	Bakır s bronze	Antrasit s. anthracite
10 mm	PQA1025001 26,5 \$	PQA1025011 35,5 \$	PQA1024421 45,5 \$	PQA1024431 55,0 \$	PQA1024441 55,0 \$
12 mm	PQA1225001 27,0 \$	PQA1225011 36,0 \$	PQA1224421 46,0 \$	PQA1224431 55,5 \$	PQA1224441 55,5 \$
14 mm	PQA1425001 27,5 \$	PQA1425011 36,5 \$	PQA1424421 46,5 \$	PQA1424431 56,0 \$	PQA1424441 56,0 \$

Ebat size	Inox Ayna mirror	Inox Parlak shine	Altın Ayna gold	Bakır Ayna bronze	Antrasit Ayna anthracite
10 mm	PQA1024400 35,5 \$	PQA1025003 26,5 \$	PQA1024420 45,5 \$	PQA1024430 55,0 \$	PQA1024440 55,0 \$
12 mm	PQA1224400 36,0 \$	PQA1225003 27,0 \$	PQA1224420 46,0 \$	PQA1224430 55,5 \$	PQA1224440 55,5 \$
14 mm	PQA1424400 36,5 \$	PQA1425003 27,5 \$	PQA1424420 46,5 \$	PQA1424430 56,0 \$	PQA1424440 56,0 \$

Profix QA seramik, mermer ve tüm kaplamalarda açılı köşe birleşimi olarak kullanılan dekoratif görünümlü paslanmaz çelikten üretilen açılı köşe profilidir.

Seramik, mermer ve tüm kaplamalarda 304 kalite paslanmaz çelikten üretilen açılı köşe profilidir. 10 farklı renk alternatifi ile üretilmektedir. Renkli ürünler PVD teknolojisi ile paslanmaz yüzeye yüksek dayanıma sahip titanyum iyon kaplama yöntemi ile üretilmektedir.

Profix QA is angle corner profile produced from 4301 grade stainless steel with offered 10 different surface colour options. All colour options produced by PVD technologies with high resistance titanium covered.

Inox (Satinox), Dekorlu (Decor), Inox Parlak (Shine) yüzeyler 250 cm boyda üretilmektedir. / Surfaces 250 cm length. Ayna (Mirror), Altın (Satine Gold), Altın ayna (Gold), Bakır (Satine bronze), Bakır Ayna (Bronze mirror), Antrasit (Satine Anthracite), Antrasit ayna (Anthracite mirror) yüzeyler 244 cm boyda üretilmektedir. / surfaces 244 cm length. Maximum boy 300 cm üretilmektedir. / Profile can be produced up to 300 cm. Paket içi adeti: 10 ADET / Products per box. Belirtilen hammadde kalınlıkları 0,80 mm dir, 0,60 mm için fiyat talep edilmelidir. Thickness is 0,80 mm. Should be request price for 0,60 mm alternatives.

TEKNİK ÖLÇÜ TABLOSU

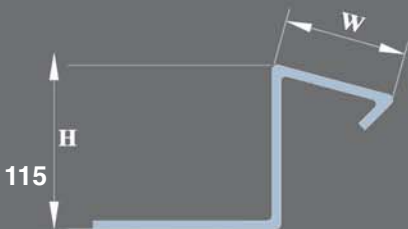

	10 mm	12 mm	14 mm
W	12	12	12
H	12	14	16



Ebat size	Inox satinox	Dekorlu decor	Altın s gold	Bakır s bronz	Antrasit s. anthracite
8 mm	PDK0825001 22,5 \$	PDK0825011 30,0 \$	PDK0824421 35,0 \$	PDK0824431 44,5 \$	PDK0824441 44,5 \$
10 mm	PDK1025001 23,0 \$	PDK1025011 30,5 \$	PDK1024421 35,5 \$	PDK1024431 45,0 \$	PDK1024441 45,0 \$
12 mm	PDK1225001 23,5 \$	PDK1225011 31,0 \$	PDK1224421 36,0 \$	PDK1224431 45,5 \$	PDK1224441 45,5 \$
14 mm	PDK1425001 24,0 \$	PDK1425011 31,5 \$	PDK1424421 36,5 \$	PDK1424431 46,0 \$	PDK1424441 46,0 \$

Ebat size	Inox Ayna mirror	Inox Parlak shine	Altın Ayna gold	Bakır Ayna bronz	Antrasit Ayna anthracite
8 mm	PDK0824400 30,0 \$	PDK0825003 22,5 \$	PDK0824420 35,0 \$	PDK0824430 44,5 \$	PDK0824440 44,5 \$
10 mm	PDK1024400 30,5 \$	PDK1025003 23,0 \$	PDK1024420 35,5 \$	PDK1024430 45,0 \$	PDK1024440 45,0 \$
12 mm	PDK1224400 31,0 \$	PDK1225003 23,5 \$	PDK1224420 36,0 \$	PDK1224430 45,5 \$	PDK1224440 45,5 \$
14 mm	PDK1424400 31,5 \$	PDK1425003 24,0 \$	PDK1424420 36,5 \$	PDK1424430 46,0 \$	PDK1424440 46,0 \$

Profix DK seramik duvar kağıdı geçişinde kullanılan duvar kağıdı kot geçiş profilidir.Seramik, mermer duvar kağıdı geçiş noktasında kullanılan 304 kalitede paslanmaz çelikten üretilen duvar kağıdı kot geçiş profilidir.

Profix DK is internal drip profile produced from 4301 grade stainless steel with offered 10 different surface colour options.All colour options produced by PVD Technologies with high resistance titanium covered .

Inox (Satinox), Dekorlu (Decor), Inox Parlak (Shine) yüzeyler 250 cm boyda üretilmektedir. / Surfaces 250 cm length. Ayna (Mirror), Altın (Satine Gold), Altın ayna (Gold), Bakır (Satine bronz), Bakır Ayna (Bronze mirror),Antrasit (Satine Anthracite), Antrasit ayna (Anthracite mirror) yüzeyler 244 cm boyda üretilmektedir. / surfaces 244 cm length. Maximum boy 300 cm üretilmektedir. / Profile can be produced up to 300 cm. Paket içi adeti: 6 ADET / Products per box. Belirtilen hammadde kalınlıkları 0,80 mm dir, 0,60 mm için fiyat talep edilmelidir. Thickness is 0,80 mm. Should be request price for 0,60 mm alternatives.

TEKNİK ÖLÇÜ TABLOSU

		8 mm	10 mm	12 mm	14 mm
	W	14,14	15,62	17,2	18,87
	H	10	12	14	16



Paslanmaz Çelik Dekoratif Profil

Profiline serisi ürünler sertifikalı 304 kalite paslanmaz çelikten üretilmektedir. Ürünün 10 farklı yüzey alternatifi (Inox, Inox Ayna, Inox Parlak, Delikli, Altın, Altın Ayna, Bakır, Bakır Ayna, Antrasit, Antrasit Ayna) mevcuttur. Renkli olan ürünler paslanmaz yüzeye pvd kaplama teknolojisi ile üretilmiştir.

PROFILINE

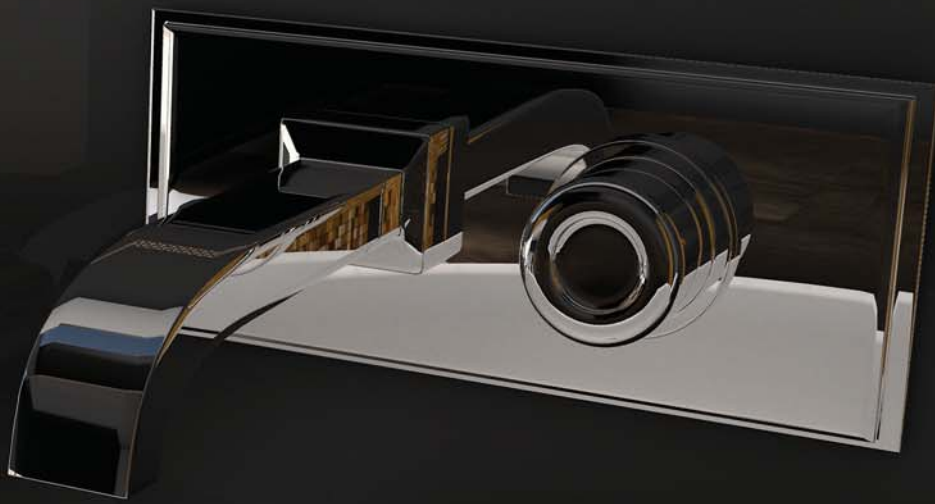

Stainless Steel Decorative Profile

DECORATIVE BORDER PROFILES are manufactured from 1st grade 304 stainless steel, has 10 different surface alternatives. Profiline offered with 10,15,23,30,48 mm surface width and produced with 10 mm thickness. Lengths are 244 cm, 250 cm,270 cm. Length are very according to surfaces alternatives.

Islak mekanlarınıza değer katan **zarif detaylar**.
Çeliğin **asıl dokusu** banyo ve mutfaklarınız da
Profiline Linear serisi ile yeni bir anlam kazanıyor.



Linear serisi ürünler sertifikalı 304 kalite paslanmaz çelikten üretilmektedir. Ürünün 10 farklı yüzey renk alternatifi (Inox, Inox Ayna, Inox Parlak Dekorlu, Altın, Altın Ayna, Bakır, Bakır Ayna, Antrasit, Antrasit Ayna) mevcuttur. Renkli olan ürünler paslanmaz yüzeye pvd kaplama teknolojisi ile üretilmiştir. Ürünün 5 farklı yüzey genişlik alternatifi mevcuttur.(10 mm, 15 mm, 23 mm, 30 mm, 48 mm)

Decorative border profiles are manufactured from 1st grade 304 stainless steel. Profiline offered with 10, 15, 23, 30, 48 mm surface width and produced with 10 mm thickness. Lengths are 244 mm, 250 mm, 270 cm. Length are very according to surface alternatives. Profiline has 10 different surface alternatives. Colored surface are titanium coated.

Ebat size	Inox satinox	Dekorlu decor	Altın s gold	Bakır s bronze	Antrasit s. anthracite
1 cm	PB1025001 14,0 \$	PB1025011 20,4 \$	PB1024421 19,5 \$	PB1024431 25,0 \$	PB1024441 25,0 \$
1.5 cm	PB1525001 15,5 \$	PB1525011 21,0 \$	PB1524421 23,5 \$	PB1524431 30,0 \$	PB1524441 30,0 \$
2.3 cm	PB2325001 18,0 \$	PB2325011 25,3 \$	PB2324421 26,0 \$	PB2324431 32,5 \$	PB2324441 32,5 \$
3 cm	PB3025001 20,0 \$	PB3025011 28,4 \$	PB3024421 30,0 \$	PB3024431 36,5 \$	PB3024441 36,5 \$
4.8 cm	PB4825001 25,0 \$	PB4825011 36,3 \$	PB4824421 40,0 \$	PB4824431 45,0 \$	PB4824441 45,0 \$

Ebat size	Inox Ayna mirror	Inox Parlak shine	Altın Ayna gold	Bakır Ayna bronze	Antrasit Ayna anthracite
1 cm	PB1024400 16,5 \$	PB1025003 14,0 \$	PB1024420 19,5 \$	PB1024430 25,0 \$	PB1024440 25,0 \$
1.5 cm	PB1524400 18,5 \$	PB1525003 15,5 \$	PB1524420 23,5 \$	PB1524430 30,0 \$	PB1524440 30,0 \$
2.3 cm	PB2324400 21,0 \$	PB2325003 18,0 \$	PB2324420 26,0 \$	PB2324430 32,5 \$	PB2324440 32,5 \$
3 cm	PB3024400 25,0 \$	PB3025003 20,0 \$	PB3024420 30,0 \$	PB3024430 36,5 \$	PB3024440 36,5 \$
4.8 cm	PB4824400 32,0 \$	PB4825003 25,0 \$	PB4824420 40,0 \$	PB4824430 45,0 \$	PB4824440 45,0 \$

Profiline Inox - Dekorlu = 250 cm / Inox Parlak = 250 cm / Altın-Altın Ayna = 244 cm / Bakır-Bakır Ayna = 244 cm / Antrasit-Antrasit Ayna = 244 cm

MADE WITH SWAROVSKI® ELEMENTS

Islak mekanlarınıza değer katan **zarif detaylar**.
Çeliğin **asil dokusu** banyo ve mutfaklarınız da
Profiline Linear serisi ile yeni bir anlam kazanıyor.



Linear E serisi ürünler sertifikalı 304 kalite paslanmaz çelikten üretilmektedir. Ürünün 10 farklı yüzey renk alternatifi (Inox, Inox Ayna, Inox Parlak Dekorlu, Altın, Altın Ayna, Bakır, Bakır Ayna, Antrasit, Antrasit Ayna) mevcuttur. Renkli olan ürünler paslanmaz yüzeye pvd kaplama teknolojisi ile üretilmiştir. Ürünün 5 farklı yüzey genişlik alternatifi mevcuttur. (10 mm, 15 mm, 23 mm, 30 mm, 48 mm)

Decorative border profiles are manufactured from 1st grade 304 stainless steel. Profiline offered with 10, 15, 23, 30, 48 mm surface width and produced with 10 mm thickness. Lengths are 244 mm, 250 mm, 270 cm. Length are very according to surface alternatives. Profiline has 10 different surface alternatives. Colored surface are titanium coated.

Ebat size	Inox satinox	Dekorlu decor	Altın s gold	Bakır s bronz	Antrasit s anthracite
1 cm	KB1025001 8,5 \$	KB1025011 11,3 \$	KB1024421 11,3 \$	KB1024431 13,0 \$	KB1024441 15,0 \$
1.5 cm	KB1525001 8,7 \$	KB1525011 11,5 \$	KB1524421 11,5 \$	KB1524431 13,1 \$	KB1524441 15,1 \$
2 cm	KB2025001 10,0 \$	KB2025011 14,0 \$	KB2024421 14,0 \$	KB2024431 14,5 \$	KB2024441 16,7 \$
2.3 cm	KB2325001 10,3 \$	KB2325011 14,2 \$	KB2324421 14,2 \$	KB2324431 14,7 \$	KB2324441 16,9 \$
3 cm	KB3025001 12,1 \$	KB3025011 16,6 \$	KB3024421 16,6 \$	KB3024431 17,1 \$	KB3024441 19,7 \$
4.8 cm	KB4825001 17,1 \$	KB4825011 23,2 \$	KB4824421 23,2 \$	KB4824431 24,2 \$	KB4824441 24,8 \$

Ebat size	Inox Ayna mirror	Inox Parlak shine	Altın Ayna gold	Bakır Ayna bronz	Antrasit Ayna anthracite
1 cm	KB1024400 9,8 \$	KB1025003 8,5 \$	KB1024420 11,3 \$	KB1024430 13,0 \$	KB1024440 15,0 \$
1.5 cm	KB1524400 10,0 \$	KB1525003 8,7 \$	KB1524420 11,5 \$	KB1524430 13,1 \$	KB1524440 15,1 \$
2 cm	KB2024400 11,8 \$	KB2025003 10,0 \$	KB2024420 14,0 \$	KB2024430 14,5 \$	KB2024440 16,7 \$
2.3 cm	KB2324400 12,1 \$	KB2325003 10,3 \$	KB2324420 14,2 \$	KB2324430 14,7 \$	KB2324440 16,9 \$
3 cm	KB3024400 14,2 \$	KB3025003 12,1 \$	KB3024420 16,6 \$	KB3024430 17,1 \$	KB3024440 19,7 \$
4.8 cm	KB4824400 23,4 \$	KB4825003 17,1 \$	KB4824420 23,2 \$	KB4824430 24,2 \$	KB4824440 24,8 \$

Profiline Inox - Dekorlu = 250 cm / Inox Parlak = 250 cm / Altın-Altın Ayna = 244 cm / Bakır-Bakır Ayna = 244 cm / Antrasit-Antrasit Ayna = 244 cm

MADE WITH SWAROVSKI® ELEMENTS

0,6 mm kalınlık / 0,6 mm thickness

Swarovski kristalleri kullanılarak üretilen mekanlarda fark yaratan bir dekoratif bordür tasarımı Diamond X.



Diamond X serisi ürünler Made with SWAROVSKI® ELEMENTS kristalleri kullanılarak, 304 kalite paslanmaz çelikten üretilmektedir. Ürünün 10 farklı yüzey renk alternatifi (Inox, Inox Ayna, Inox Parlak, Dekorlu, Altın, Altın Ayna, Bakır, Bakır Ayna, Antrasit, Antrasit Ayna) mevcuttur. Renkli olan ürünler paslanmaz yüzeye pvd kaplama teknolojisi ile üretilmiştir. Ürünün 5 farklı yüzey genişlik alternatifi mevcuttur. (10 mm, 15 mm, 23 mm, 30 mm, 48 mm)

Decorative border profiles are manufactured from 1st grade 304 stainless steel. Profiline offered with 10, 15, 23, 30, 48 mm surface width and produced with 10 mm thickness. Lengths are 244 mm, 250 mm, 270 cm. Length are very according to surface alternatives. Profiline has 10 different surface alternatives. Colored surface are titanium coated. Diamond X MADE WITH SWAROVSKI® ELEMENTS.

Ebat Size	Inox Satinox	Dekorlu Decor	Altın S. Gold	Bakır S. Bronze	Antrasit S. Anthracite
1 cm	PB1025001 55,5 \$	PB1025011 83,6 \$	PB1024421 70,0 \$	PB1024431 95,2 \$	PB1024441 93,1 \$
1.5 cm	PB1525001 59,6 \$	PB1525011 92,2 \$	PB1524421 76,1 \$	PB1524431 105,5 \$	PB1524441 103,2 \$
2.3 cm	PB2325001 64,2 \$	PB2325011 98,8 \$	PB2324421 81,7 \$	PB2324431 115,7 \$	PB2324441 113,0 \$
3 cm	PB3025001 72,3 \$	PB3025011 105,3 \$	PB3024421 96,0 \$	PB3024431 125,7 \$	PB3024441 122,5 \$
4.8 cm	PB4825001 97,6 \$	PB4825011 127,1 \$	PB4824421 127,5 \$	PB4824431 155,8 \$	PB4824441 151,5 \$

Ebat Size	Inox Ayna Mirror	Inox Parlak Shine	Altın Ayna Gold	Bakır Ayna Bronze	Antrasit Ayna Anthracite
1 cm	PB1024400 62,2 \$	PB1025003 55,5 \$	PB1024420 70,0 \$	PB1024430 95,2 \$	PB1024440 93,1 \$
1.5 cm	PB1524400 67,2 \$	PB1525003 59,6 \$	PB1524420 76,1 \$	PB1524430 105,5 \$	PB1524440 103,2 \$
2.3 cm	PB2324400 72,2 \$	PB2325003 64,2 \$	PB2324420 81,7 \$	PB2324430 115,7 \$	PB2324440 113,0 \$
3 cm	PB3024400 83,6 \$	PB3025003 72,3 \$	PB3024420 96,0 \$	PB3024430 125,7 \$	PB3024440 122,5 \$
4.8 cm	PB4824400 111,5 \$	PB4825003 97,6 \$	PB4824420 127,5 \$	PB4824430 155,8 \$	PB4824440 151,5 \$

Profiline Inox - Dekorlu = 250 cm / Inox Parlak = 250 cm / Altın-Altın Ayna = 244 cm / Bakır-Bakır Ayna = 244 cm / Antrasit-Antrasit Ayna = 244 cm

MADE WITH SWAROVSKI® ELEMENTS

Swarovski kristalleri kullanılarak üretilen mekanlarda fark yaratan bir dekoratif bordür tasarımı **Diamond X E**.



Diamond X E serisi ürünler Made with SWAROVSKI® ELEMENTS kristalleri kullanılarak, 304 kalite paslanmaz çelikten üretilmektedir. Ürünün 10 farklı yüzey renk alternatifi (Inox, Inox Ayna, Inox Parlak, Dekorlu, Altın, Altın Ayna, Bakır, Bakır Ayna, Antrasit, Antrasit Ayna) mevcuttur. Renkli olan ürünler paslanmaz yüzeye pvd kaplama teknolojisi ile üretilmiştir. Ürünün 5 farklı yüzey genişlik alternatifi mevcuttur. (10 mm, 15 mm, 23 mm, 30 mm, 48 mm)

Decorative border profiles are manufactured from 1st grade 304 stainless steel. Profiline offered with 10, 15, 23, 30, 48 mm surface width and produced with 10 mm thickness. Lengths are 244 mm, 250 mm, 270 cm. Length are very according to surface alternatives. Profiline has 10 different surface alternatives. Colored surface are titanium coated. Diamond X E MADE WITH SWAROVSKI® ELEMENTS.

Ebat Size	Inox Satinox	Dekorlu Decor	Altın S. Gold	Bakır S. Bronze	Antrasit S. Anthracite
1 cm	KB10250011 23,0 \$	KB10250111 31,0 \$	KB10244211 31,0 \$	KB10244201 31,0 \$	KB10244411 31,0 \$
1.5 cm	KB15250011 24,3 \$	KB15250111 33,7 \$	KB15244211 33,7 \$	KB15244201 35,1 \$	KB15244411 35,1 \$
2 cm	KB20250011 27,0 \$	KB20250111 37,8 \$	KB20244211 37,8 \$	KB20244201 37,8 \$	KB20244411 37,8 \$
2.3 cm	KB23250011 28,3 \$	KB23250111 40,5 \$	KB23244211 40,5 \$	KB23244201 40,5 \$	KB23244411 40,5 \$
3 cm	KB30250011 31,0 \$	KB30250111 44,5 \$	KB30244211 44,5 \$	KB30244201 46,0 \$	KB30244411 46,0 \$
4.8 cm	KB48250011 43,2 \$	KB48250111 54,0 \$	KB48244211 54,0 \$	KB48244201 54,0 \$	KB48244411 54,0 \$

Ebat Size	Inox Ayna Mirror	Inox Parlak Shine	Altın Ayna Gold	Bakır Ayna Bronze	Antrasit Ayna Anthracite
1 cm	KB10244001 25,6 \$	KB10250031 23,0 \$	KB10244201 31,0 \$	KB10244301 31,0 \$	KB10244401 31,0 \$
1.5 cm	KB15244001 28,3 \$	KB15250031 24,3 \$	KB15244201 33,7 \$	KB15244301 35,1 \$	KB15244401 35,1 \$
2 cm	KB20244001 32,4 \$	KB20250031 27,0 \$	KB20244201 37,8 \$	KB20244301 37,8 \$	KB20244401 37,8 \$
2.3 cm	KB23244001 35,1 \$	KB23250031 28,3 \$	KB23244201 40,5 \$	KB23244301 40,5 \$	KB23244401 40,5 \$
3 cm	KB30244001 37,8 \$	KB30250031 31,0 \$	KB30244201 44,5 \$	KB30244301 46,0 \$	KB30244401 46,0 \$
4.8 cm	KB48244001 51,3 \$	KB48250031 43,2 \$	KB48244201 54,0 \$	KB48244301 54,0 \$	KB48244401 54,0 \$

Profiline Inox - Dekorlu = 250 cm / Inox Parlak = 250 cm / Altın-Altın Ayna = 244 cm / Bakır-Bakır Ayna = 244 cm / Antrasit-Antrasit Ayna = 244 cm

MADE WITH SWAROVSKI® ELEMENTS

0,6 mm kalınlık / 0,6 mm thickness

Mücevher misali çok şık mekanlar
Diamond Tile serisi ürünler ile tasarlandı.



Diamond Tile serisi ürünler Made with SWAROVSKI® ELEMENTS kristalleri kullanılarak, 304 kalite paslanmaz çelikten üretilmektedir. Ürünün 10 farklı yüzey renk alternatifi (Inox, Inox Ayna, Inox Parlak, Dekorlu, Altın, Altın Ayna, Bakır, Bakır Ayna, Antrasit, Antrasit Ayna) mevcuttur. Renkli olan ürünler paslanmaz yüzeye pvd kaplama teknolojisi ile üretilmiştir. Ürünün 3 farklı yüzey genişlik alternatifi mevcuttur. (23 mm, 30 mm, 48 mm)

Decorative border profiles are manufactured from 1st grade 304 stainless steel. Profiline offered with 23, 30, 48 mm surface width and produced with 10 mm thickness. Lengths are 244 mm, 250 mm, 270 cm. Length are very according to surface alternatives. Profiline has 10 different surface alternatives. Colored surface are titanium coated. Diamond Tile MADE WITH SWAROVSKI® ELEMENTS.

Ebat Size	Inox Satinox	Dekorlu Decor	Altın S. Gold	Bakır S. Bronze	Antrasit S. Anthracite
2.3 cm	PB23250012 144,8 \$	PB23250112 152,5 \$	PB23244212 151,5 \$	PB23244312 165,1 \$	PB23244412 162,3 \$
3 cm	PB30250012 146,8 \$	PB30250112 155,6 \$	PB30244212 156,1 \$	PB30244312 172,0 \$	PB30244412 168,7 \$
4.8 cm	PB48250012 215,7 \$	PB48250112 227,1 \$	PB48244212 226,6 \$	PB48244312 248,1 \$	PB48244412 243,7 \$

Ebat Size	Inox Ayna Mirror	Inox Parlak Shine	Altın Gold	Bakır Ayna Bronze	Antrasit Ayna Anthracite
2.3 cm	PB23244002 146,2 \$	PB23250032 140,0 \$	PB23244202 151,5 \$	PB23244302 165,1 \$	PB23244402 162,3 \$
3 cm	PB30244002 150,0 \$	PB30250032 142,0 \$	PB30244202 156,1 \$	PB30244302 172,0 \$	PB30244402 168,7 \$
4.8 cm	PB48244002 218,3 \$	PB48250032 208,5 \$	PB48244202 226,6 \$	PB48244302 248,1 \$	PB48244402 243,7 \$

Profiline Inox - Dekorlu = 250 cm / Inox Parlak = 250 cm / Altın-Altın Ayna = 244 cm / Bakır-Bakır Ayna = 244 cm / Antrasit-Antrasit Ayna = 244 cm

MADE WITH SWAROVSKI® ELEMENTS

Sanatsal banyolar yaratıyor Diamond Form serisi...
Geometrik tasarımlar, SWAROVSKI ELEMENTS
kristallerinin büyüklü ışıltısı çeliğin kimyası değiştiriyor.

Diamond Form serisi ürünler Made with SWAROVSKI® ELEMENTS kristalleri kullanılarak, 304 kalite paslanmaz çelikten üretilmektedir. Ürünün 10 farklı yüzey renk alternatifi (Inox, Inox Ayna, Inox Parlak, Dekorlu, Altın, Altın Ayna, Bakır, Bakır Ayna, Antrasit, Antrasit Ayna) mevcuttur. Renkli olan ürünler paslanmaz yüzeye pvd kaplama teknolojisi ile üretilmiştir. Ürünün 3 farklı yüzey genişlik alternatifi mevcuttur. (30 mm, 48 mm)

Decorative border profiles are manufactured from 1st grade 304 stainless steel. Profiline offered with 30 and 48 mm surface width and produced with 10 mm thickness. Lengths are 244 mm, 250 mm, 270 cm. Length are very according to surface alternatives. Profiline has 10 different surface alternatives. Colored surface are titanium coated. Diamond Form MADE WITH SWAROVSKI® ELEMENTS.



Ebat Size	Kristal Ebat Size	Inox Satinox	Dekorlu Decor	Altın S Gold	Bakır S. Bronze	Antrasit S. Anthracite
3 cm	4x4 cm	PB30250013 127,0 \$	PB30250113 135,7 \$	PB30244213 136,3 \$	PB30244313 152,2 \$	PB30244413 149,0 \$
4.8 cm	4x6 cm	PB48250013 171,8 \$	PB48250113 183,2 \$	PB48244213 184,1 \$	PB48244313 205,6 \$	PB48244413 201,2 \$
3 cm	4x10 cm	PB30250014 137,3 \$	PB30250114 146,1 \$	PB30244214 143,3 \$	PB30244314 159,2 \$	PB30244413 156,0 \$
4.8 cm	6x15 cm	PB48250014 211,1 \$	PB48250114 222,5 \$	PB48244214 215,5 \$	PB48244314 237,0 \$	PB48244413 232,6 \$

Ebat Size	Kristal Ebat Size	Inox Ayna Mirror	Inox Parlak Shine	Altın Ayna Gold	Bakır Ayna Bronze	Antrasit Ayna Anthracite
3 cm	4x4 cm	PB30244003 130,2 \$	PB30250033 117,2 \$	PB30244203 136,3 \$	PB30244303 152,2 \$	PB30244403 149,0 \$
4.8 cm	4x6 cm	PB48244003 175,8 \$	PB48250033 158,5 \$	PB48244203 184,1 \$	PB48244303 205,6 \$	PB48244403 201,2 \$
3 cm	4x10 cm	PB30244004 137,2 \$	PB30250034 124,2 \$	PB30244204 143,3 \$	PB30244304 159,2 \$	PB30244403 156,0 \$
4.8 cm	6x15 cm	PB48244004 207,2 \$	PB48250034 189,8 \$	PB48244204 215,5 \$	PB48244304 237,0 \$	PB48244403 232,6 \$

Profiline Inox - Dekorlu = 250 cm / Inox Parlak = 250 cm / Altın-Altın Ayna = 244 cm / Bakır-Bakır Ayna = 244 cm / Antrasit-Antrasit Ayna = 244 cm

MADE WITH SWAROVSKI® ELEMENTS

Diamond Art serisi
Sanatsal banyolar yaratıyor ...



SWAROVSKI® ELEMENTS
kristallerinin büyüğü ışığı çeliğin kimyası değiştiriyor.

Ebat Size	Kristal Ebat Size	Inox Satinox	Dekorlu Decor	Altın S. Gold	Bakır S. Bronze	Antrasit S. Anthracite					
3 cm	1x1 cm	PB30250015	170,8 \$	PB30250115	179,6 \$	PB30244215	176,2 \$	PB30244315	192,1 \$	PB30244415	188,8 \$
4.8 cm	2.5x2.5 cm	PB48250015	176,1 \$	PB48250115	187,5 \$	PB48244215	188,0 \$	PB48244315	209,5 \$	PB48244415	205,1 \$
4.8 cm	1x1 cm	PB48250016	231,1 \$	PB48250116	242,5 \$	PB48244216	238,0 \$	PB48244316	259,5 \$	PB48244416	255,1 \$
4.8 cm	0=2 cm	PB48250017	217,3 \$	PB48250117	228,7 \$	PB48244217	225,5 \$	PB48244317	247,0 \$	PB48244417	242,6 \$

Ebat Size	Kristal Ebat Size	Inox Ayna Mirror	Inox Parlak Shine	Altın Ayna Gold	Bakır Ayna Bronze	Antrasit Ayna Anthracite					
3 cm	1x1 cm	PB30244005	170,8 \$	PB30250035	157,1 \$	PB30244205	176,2 \$	PB30244305	192,1 \$	PB30244405	188,8 \$
4.8 cm	2.5x2.5 cm	PB48244005	176,1 \$	PB48250035	162,3 \$	PB48244205	188,0 \$	PB48244305	209,5 \$	PB48244405	205,1 \$
4.8 cm	1x1 cm	PB48244006	231,1 \$	PB48250036	212,3 \$	PB48244206	238,0 \$	PB48244306	259,5 \$	PB48244406	255,1 \$
4.8 cm	0=2 cm	PB48244007	217,3 \$	PB48250037	199,8 \$	PB48244207	225,5 \$	PB48244307	247,0 \$	PB48244407	242,6 \$

Profiline Inox - Dekorlu = 250 cm / Inox Parlak = 250 cm / Altın-Altın Ayna = 244 cm / Bakır-Bakır Ayna = 244 cm / Antrasit-Antrasit Ayna = 244 cm

MADE WITH SWAROVSKI® ELEMENTS

Kendinizi özel hissetmenizi sağlayacak detaylar.
Diamond Lux serisi exclusive bir mekan
yaratmak isteyenler için tasarlandı.

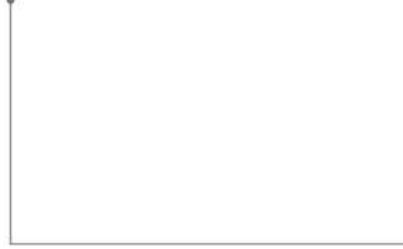

Diamond LUX serisi ürünler Made with SWAROVSKI® ELEMENTS. TS kristalleri kullanılarak, sertifikalı 304 kalite paslanmaz çelikten üretilmektedir. Ürünün 10 farklı yüzey renk alternatifi (Inox, Inox Ayna, Inox Parlak, Dekorlu, Altın, Altın Ayna, Bakır, Bakır Ayna, Antrasit, Antrasit Ayna) mevcuttur. Renkli olan ürünler paslanmaz yüzeye pvd kaplama teknolojisi ile üretilmiştir. Ürünün 5 farklı yüzey genişlik alternatifi mevcuttur.(10 mm, 15 mm, 23 mm, 30 mm, 48 mm)

Decorative border profiles are manufactured from 1st grade 304 stainless steel. Profiline offered with 10, 15, 23, 30, 48 mm surface width and produced with 10 mm thickness. Lengths are 244 mm, 250 mm, 270 cm. Length are very according to surface alternatives. Profiline has 10 different surface alternatives. Colored surface are titanium coated. Diamond Lux MADE WITH SWAROVSKI® ELEMENTS.

Ebat Size	Inox Satinox	Inox Ayna Mirror	Altın S. Gold	Bakır S. Bronze	Antrasit S. Anthracite
1 cm	PB10250019 360,5 \$	PB10244219 338,2 \$	PB10244219 338,2 \$	PB10244319 348,3 \$	PB10244419 346,3 \$
1.5 cm	PB15250019 534,7 \$	PB15244219 498,6 \$	PB15244219 498,6 \$	PB15244319 510,0 \$	PB15244419 507,6 \$
2.3 cm	PB23250019 883,0 \$	PB23244219 814,8 \$	PB23244219 814,8 \$	PB23244319 828,5 \$	PB23244419 825,7 \$
3 cm	PB30250019 1.231,2 \$	PB30244219 1.133,0 \$	PB30244219 1.133,0 \$	PB30244319 1.148,8 \$	PB30244419 1.145,6 \$
4.8 cm	PB48250019 1.928,7 \$	PB48244219 1.769,7 \$	PB48244219 1.769,7 \$	PB48244319 1.791,2 \$	PB48244419 1.786,8 \$

Profiline Inox - Dekorlu = 250 cm / Inox Parlak = 250 cm / Altın-Altın Ayna = 244 cm / Bakır-Bakır Ayna = 244 cm / Antrasit-Antrasit Ayna = 244 cm

MADE WITH SWAROVSKI® ELEMENTS

ARMONİ



LALEZAR



SARMAŞIK

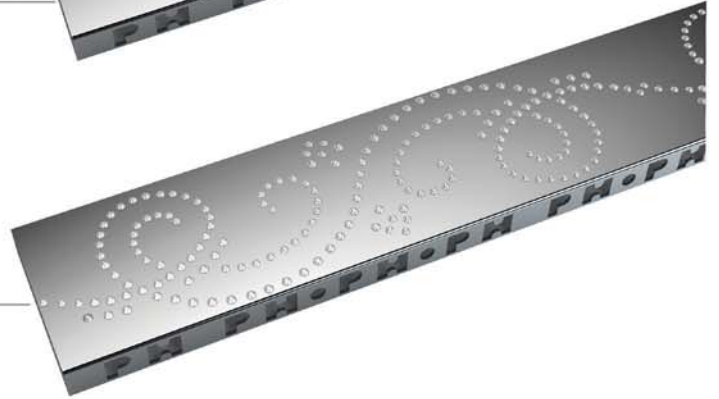

	Inox Satinox	Dekorlu Decor	Altın S. Gold	Bakır S. Bronze	Antrasit S. Anthracite
Armoni	PB4825001A 362,3 \$	PB4825011A 373,7 \$	PB4824421A 355,5 \$	PB4824431A 377,0 \$	PB4824441A 372,6 \$
Lalezar	PB48250018 362,3 \$	PB48250118 373,7 \$	PB48244218 355,5 \$	PB48244318 377,0 \$	PB48244418 372,6 \$
Sarmaşık	PB4825001S 868,6 \$	PB4825011S 880,0 \$	PB4824421S 813,0 \$	PB4824431S 834,5 \$	PB4824441S 830,1 \$

	Inox Ayna Mirror	Inox Parlak Shine	Altın Ayna Gold	Bakır Ayna Bronze	Antrasit Ayna Anthracite
Armoni	PB4824400A 347,2 \$	PB4825003A 337,3 \$	PB4824420A 355,5 \$	PB4824430A 377,0 \$	PB4824440A 372,6 \$
Lalezar	PB48244008 347,2 \$	PB48250038 337,3 \$	PB48244208 355,5 \$	PB48244308 377,0 \$	PB48244408 372,6 \$
Sarmaşık	PB4824400S 804,7 \$	PB4825003S 806,1 \$	PB4824420S 813,0 \$	PB4824430S 834,5 \$	PB4824440S 830,1 \$

Profiline Inox - Dekorlu = 250 cm / Inox Parlak = 250 cm / Altın-Altın Ayna = 244 cm / Bakır-Bakır Ayna = 244 cm / Antrasit-Antrasit Ayna = 244 cm

MADE WITH SWAROVSKI® ELEMENTS

Profiline **Diamond Shine** dekoratif görünümüyle mekana **şıklık** katan paslanmaz **çelik**ten üretilen bitiş profilidir.

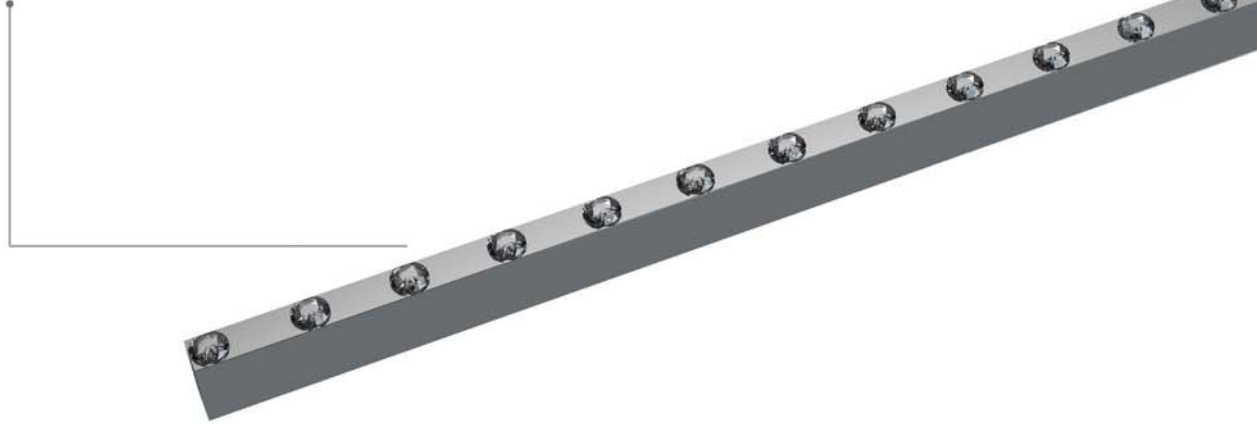

Islak mekanlarınıza değer katan zarif detaylar ... Çeliğin asil dokunuşu ve Swarovski kristallerinin oluşturduğu şıklıkla birleşen Diamond Shine seramik yüzeylerin dış köşelerine ve seramik aralarına dekoratif bordür olarak kullanılabilen özel bir profildir.

Elegant detail for bathroom with Profiline Diamond Shine. Made with SWAROVSKI® ELEMENTS.

Ebat Size	Inox Satinox	Dekorlu Decor	Altın S. Gold	Bakır S. Bronze	Antrasit S. Anthracite
0.8 mm	PBS0825001 200,0 \$	PBS0825011 212,5 \$	PBS0824421 218,7 \$	PBS0824431 237,5 \$	PBS0824441 231,2 \$
10 mm	PBS1025001 200,0 \$	PBS1025011 212,5 \$	PBS1024421 218,7 \$	PBS1024431 237,5 \$	PBS1024441 231,2 \$
12 mm	PBS1225001 200,0 \$	PBS1225011 212,5 \$	PBS1224421 218,7 \$	PBS1224431 237,5 \$	PBS1224441 231,2 \$
14 mm	PBS1425001 200,0 \$	PBS1425011 212,5 \$	PBS1424421 218,7 \$	PBS1424431 237,5 \$	PBS1424441 231,2 \$

Ebat Size	Inox Ayna Mirror	Inox Parlak Shine	Altın Ayna Gold	Bakır Ayna Bronze	Antrasit Ayna Anthracite
0.8 mm	PBS0824400 212,5 \$	PBS0825003 200,0 \$	PBS0824420 218,7 \$	PBS0824430 237,5 \$	PBS0824440 231,2 \$
10 mm	PBS1024400 212,5 \$	PBS1025003 200,0 \$	PBS1024420 218,7 \$	PBS1024430 237,5 \$	PBS1024440 231,2 \$
12 mm	PBS1224400 212,5 \$	PBS1225003 200,0 \$	PBS1224420 218,7 \$	PBS1224430 237,5 \$	PBS1224440 231,2 \$
14 mm	PBS1424400 212,5 \$	PBS1425003 200,0 \$	PBS1424420 218,7 \$	PBS1424430 237,5 \$	PBS1424440 231,2 \$

Profiline Inox - Dekorlu = 250 cm / Inox Parlak = 250 cm / Altın-Altın Ayna = 244 cm / Bakır-Bakır Ayna = 244 cm / Antrasit-Antrasit Ayna = 244 cm

MADE WITH SWAROVSKI® ELEMENTS

ottoman firuze LINEAR



ottoman hanedan LINEAR



ottoman kaside LINEAR



	Ebat Size	Inox Satinox	Inox Ayna Mirror	Inox Parlak Shine	Altın S. Gold	Altın Ayna Gold
Firuze	2.3 cm	PB232500118 100,0 \$	PB232440018 112,5 \$	PB232500318 100,0 \$	PB232442118 125,0 \$	PB232442018 125,0 \$
	3 cm	PB302500118 106,2 \$	PB302440018 118,7 \$	PB302500318 106,2 \$	PB302442118 131,2 \$	PB302442018 131,2 \$
	4.8 cm	PB482500118 112,5 \$	PB482440018 125,0 \$	PB482500318 112,5 \$	PB482442118 137,5 \$	PB482442018 137,5 \$
Hanedan	2.3 cm	PB232500119 100,0 \$	PB232440019 112,5 \$	PB232500319 100,0 \$	PB232442119 125,0 \$	PB232442019 125,0 \$
	3 cm	PB302500119 106,2 \$	PB302440019 118,7 \$	PB302500319 106,2 \$	PB302442119 131,2 \$	PB302442019 131,2 \$
	4.8 cm	PB482500119 112,5 \$	PB482440019 125,0 \$	PB482500319 112,5 \$	PB482442119 137,5 \$	PB482442019 137,5 \$
Kaside	2.3 cm	PB232500120 100,0 \$	PB232440020 112,5 \$	PB232500320 100,0 \$	PB232442120 125,0 \$	PB232442020 125,0 \$
	3 cm	PB302500120 106,2 \$	PB302440020 118,7 \$	PB302500320 106,2 \$	PB302442120 131,2 \$	PB302442020 131,2 \$
	4.8 cm	PB482500120 112,5 \$	PB482440020 125,0 \$	PB482500320 112,5 \$	PB482442120 137,5 \$	PB482442020 137,5 \$

	Ebat Size	Bakır S. Bronze	Bakır Ayna Bronze	Antrasit S. Anthracite	Antrasit Ayna Anthracite
Firuze	2.3 cm	PB232443118 137,5 \$	PB232443018 137,5 \$	PB232444118 137,5 \$	PB232444018 137,5 \$
	3 cm	PB302443118 143,7 \$	PB302443018 143,7 \$	PB302444118 143,7 \$	PB302444018 143,7 \$
	4.8 cm	PB482443118 150,0 \$	PB482443018 150,0 \$	PB482444118 150,0 \$	PB482444018 150,0 \$
Hanedan	2.3 cm	PB232443119 137,5 \$	PB232443019 137,5 \$	PB232444119 137,5 \$	PB232444019 137,5 \$
	3 cm	PB302443119 143,7 \$	PB302443019 143,7 \$	PB302444119 143,7 \$	PB302444019 143,7 \$
	4.8 cm	PB482443119 150,0 \$	PB482443019 150,0 \$	PB482444119 150,0 \$	PB482444019 150,0 \$
Kaside	2.3 cm	PB232443120 137,5 \$	PB232443020 137,5 \$	PB232444120 137,5 \$	PB232444020 137,5 \$
	3 cm	PB302443120 143,7 \$	PB302443020 143,7 \$	PB302444120 143,7 \$	PB302444020 143,7 \$
	4.8 cm	PB482443120 150,0 \$	PB482443020 150,0 \$	PB482444120 150,0 \$	PB482444020 150,0 \$

Profiline Inox - Dekorlu = 250 cm / Inox Parlak = 250 cm / Altın-Altın Ayna = 244 cm / Bakır-Bakır Ayna = 244 cm / Antrasit-Antrasit Ayna = 244 cm

MADE WITH SWAROVSKI® ELEMENTS

ottoman firuze DIAMOND

Ottoman DIAMOND serisi ürünler Made with SWAROVSKI® ELEMENTS. TS kristalleri kullanılarak sertifikalı 304 kalite paslanmaz çelikten üretilmektedir. Ürünün 10 farklı yüzey renk alternatifi (Inox, Inox Ayna, Inox Parlak, Dekorlu, Altın, Altın Ayna, Bakır, Bakır Ayna, Antrasit, Antrasit Ayna) mevcuttur. Renkli olan ürünler paslanmaz yüzeye pvd kaplama teknolojisi ile üretilmiştir. Ürünün 48 mm yüzey genişlik alternatifi mevcuttur.

ottoman hanedan DIAMOND

Decorative border profiles are manufactured from 1st grade 304 stainless steel. Profiline offered with 48 mm surface width and produced with 10 mm thickness. Lengths are 244 mm, 250 mm, 270 cm. Length are very according to surface alternatives. Profiline has 10 different surface alternatives. Colored surface are titanium coated. Ottoman DIAMOND Made with SWAROVSKI® ELEMENTS.

ottoman kaside DIAMOND

	Ebat Size	Inox Satinox	Inox Ayna Mirror	Inox Parlak Decor	Altın S. Gold	Altın Ayna Gold
Firuze	2.3 cm	PB232500115 125,0 \$	PB232440015 137,5 \$	PB232500315 125,0 \$	PB232442115 150,0 \$	PB232442015 150,0 \$
	3 cm	PB302500115 137,5 \$	PB302440015 150,0 \$	PB302500315 137,5 \$	PB302442115 162,5 \$	PB302442015 162,5 \$
	4.8 cm	PB482500115 150,0 \$	PB482440015 162,5 \$	PB482500315 150,0 \$	PB482442115 175,0 \$	PB482442015 175,0 \$
Hanedan	2.3 cm	PB232500113 125,0 \$	PB232440013 137,5 \$	PB232500313 125,0 \$	PB232442113 150,0 \$	PB232442013 150,0 \$
	3 cm	PB302500113 137,5 \$	PB302440013 150,0 \$	PB302500313 137,5 \$	PB302442113 162,5 \$	PB302442013 162,5 \$
	4.8 cm	PB482500113 150,0 \$	PB482440013 162,5 \$	PB482500313 150,0 \$	PB482442113 175,0 \$	PB482442013 175,0 \$
Kaside	2.3 cm	PB232500114 125,0 \$	PB232440014 137,5 \$	PB232500314 125,0 \$	PB232442114 150,0 \$	PB232442014 150,0 \$
	3 cm	PB302500114 137,5 \$	PB302440014 150,0 \$	PB302500314 137,5 \$	PB302442114 162,5 \$	PB302442014 162,5 \$
	4.8 cm	PB482500114 150,0 \$	PB482440014 162,5 \$	PB482500314 150,0 \$	PB482442114 175,0 \$	PB482442014 175,0 \$

	Ebat Size	Bakır S. Bronze	Bakır Ayna Bronze	Antrasit S. Anthracite	Antrasit Ayna Anthracite
Firuze	2.3 cm	PB232443115 162,5 \$	PB232443015 162,5 \$	PB232444115 162,5 \$	PB232444015 162,5 \$
	3 cm	PB302443115 175,0 \$	PB302443015 175,0 \$	PB302444115 175,0 \$	PB302444015 175,0 \$
	4.8 cm	PB482443115 187,5 \$	PB482443015 187,5 \$	PB482444115 187,5 \$	PB482444015 187,5 \$
Hanedan	2.3 cm	PB232443113 162,5 \$	PB232443013 162,5 \$	PB232444113 162,5 \$	PB232444013 162,5 \$
	3 cm	PB302443113 175,0 \$	PB302443013 175,0 \$	PB302444113 175,0 \$	PB302444013 175,0 \$
	4.8 cm	PB482443113 187,5 \$	PB482443013 187,5 \$	PB482444113 187,5 \$	PB482444013 187,5 \$
Kaside	2.3 cm	PB232443114 162,5 \$	PB232443014 162,5 \$	PB232444114 162,5 \$	PB232444014 162,5 \$
	3 cm	PB302443114 175,0 \$	PB302443014 175,0 \$	PB302444114 175,0 \$	PB302444014 175,0 \$
	4.8 cm	PB482443114 187,5 \$	PB482443014 187,5 \$	PB482444114 187,5 \$	PB482444014 187,5 \$

Profiline Inox - Dekorlu = 250 cm / Inox Parlak = 250 cm / Altın-Altın Ayna = 244 cm / Bakır-Bakır Ayna = 244 cm / Antrasit-Antrasit Ayna = 244 cm

MADE WITH SWAROVSKI® ELEMENTS

ottoman abide DIAMOND



ottoman şahmaran DIAMOND



	Ebat Size	Inox Satinox	Inox Ayna Mirror	Inox Parlak Decor	Altın S. Gold	Altın Ayna Gold
Abide	2.3 cm	PB232500116	PB232440016	PB232500316	PB232442116	PB232442016
	3 cm	PB302500116	PB302440016	PB302500316	PB302442116	PB302442016
	4.8 cm	PB482500116	PB482440016	PB482500316	PB482442116	PB482442016
Şahmaran	2.3 cm	PB232500117	PB232440017	PB232500317	PB232442117	PB232442017
	3 cm	PB302500117	PB302440017	PB302500317	PB302442117	PB302442017
	4.8 cm	PB482500117	PB482440017	PB482500317	PB482442117	PB482442017

	Ebat Size	Bakır S. Bronze	Bakır Ayna Bronze	Antrasit S. Anthracite	Antrasit Ayna Anthracite
Abide	2.3 cm	PB232443116	PB232443016	PB232444116	PB232444016
	3 cm	PB302443116	PB302443016	PB302444116	PB302444016
	4.8 cm	PB482443116	PB482443016	PB482444116	PB482444016
Şahmaran	2.3 cm	PB232443117	PB232443017	PB232444117	PB232444017
	3 cm	PB302443117	PB302443017	PB302444117	PB302444017
	4.8 cm	PB482443117	PB482443017	PB482444117	PB482444017

Profiline Inox - Dekorlu = 250 cm / Inox Parlak = 250 cm / Altın-Altın Ayna = 244 cm / Bakır-Bakır Ayna = 244 cm / Antrasit-Antrasit Ayna = 244 cm

MADE WITH SWAROVSKI® ELEMENTS

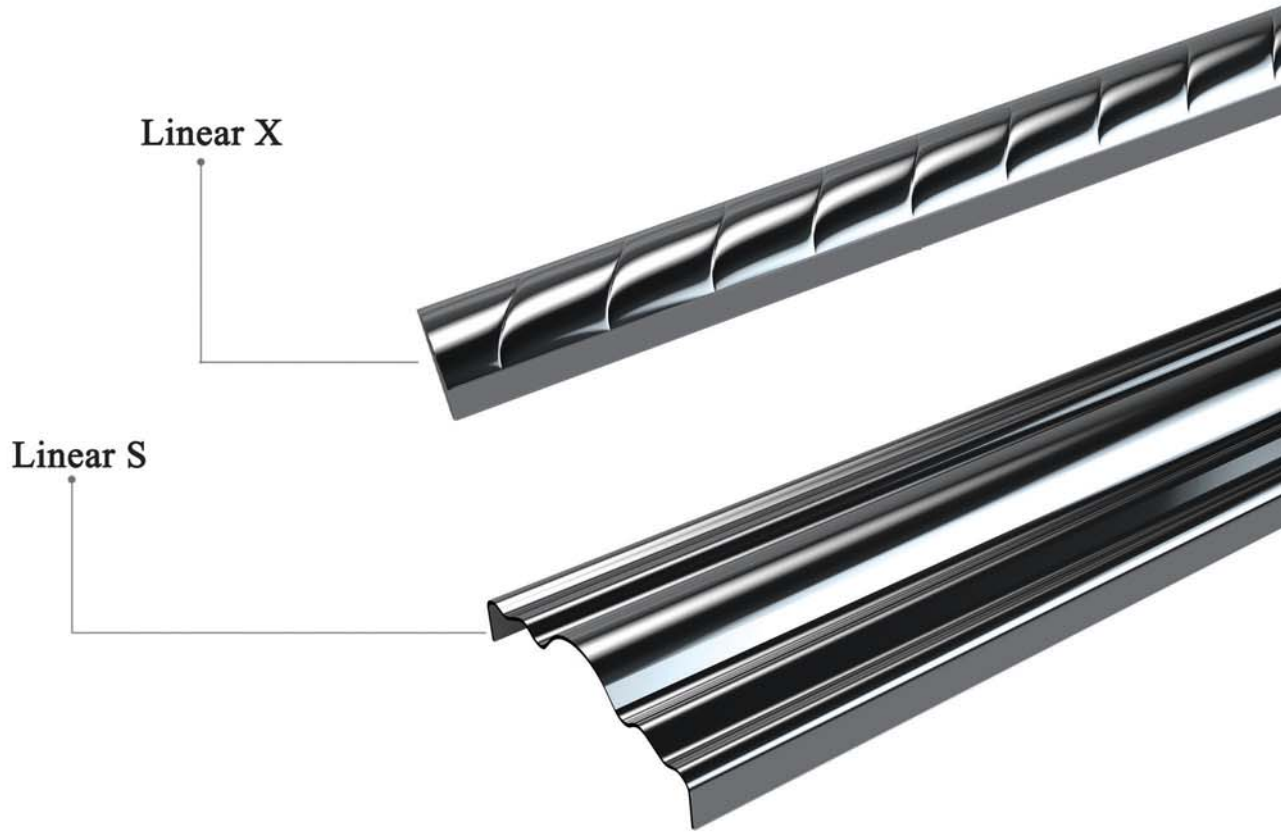

Linear X

EBAT size	Inox Satinox	Dekorlu Decor	Altın S Gold	Bakır S Bronze	Antrasit S Anthracite
2 cm	PB200600140	6,2 \$	PB200602140	12,6 \$	PB200604140

EBAT size	Inox Ayna Mirror	Inox Parlak Shine	Altın Ayna Gold	Bakır Ayna Bronze	Antrasit Ayna Anthracite
2 cm	PB200600040	10,5 \$	PB200602040	12,6 \$	PB200604040

Linear S

EBAT size	Inox Satinox	Dekorlu Decor	Altın S Gold	Bakır S Bronze	Antrasit S Anthracite
6 x 60 cm	PB600600141	10,8 \$	PB600602141	20,5 \$	PB600604141
6 x 90 cm	PB600900141	21,7 \$	PB600902141	41,7 \$	PB600904141
6 x 120 cm	PB601200141	27,1 \$	PB601202141	50,0 \$	PB601204141

EBAT size	Inox Ayna Mirror	Inox Parlak Shine	Altın Ayna Gold	Bakır Ayna Bronze	Antrasit Ayna Anthracite
6 x 60 cm	PB600600041	16,8 \$	PB600602041	20,5 \$	PB600604041
6 x 90 cm	PB600900041	33,6 \$	PB600902041	41,7 \$	PB600904041
6 x 120 cm	PB601200041	16,8 \$	PB601202041	50,0 \$	PB601204041

Profiline Inox - Dekorlu = 250 cm / Inox Parlak = 250 cm / Altın-Altın Ayna = 244 cm / Bakır-Bakır Ayna = 244 cm / Antrasit-Antrasit Ayna = 244 cm

MADE WITH SWAROVSKI® ELEMENTS



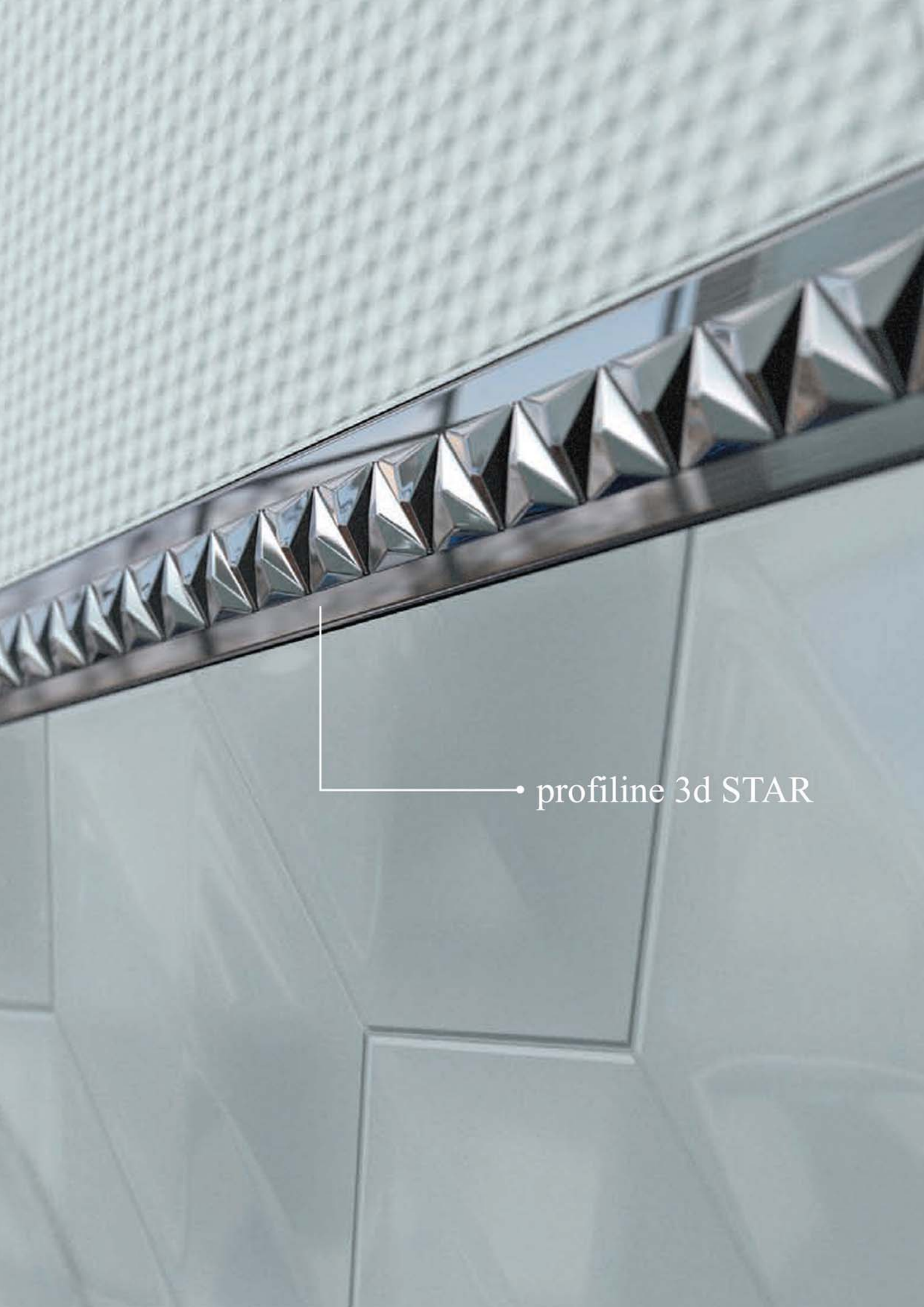

• profiline 3d STAR

PROFILINE 3D

R Dizayn

3d STAR W

EBAT size	Inox Satinox	Inox Ayna Mirror	Altın Ayna Gold	Bakır Ayna Bronze
7 cm	PB702700128 120,0 \$	PB702440028 171,2 \$	PB702442028 200,0 \$	PB702443028 241,2 \$

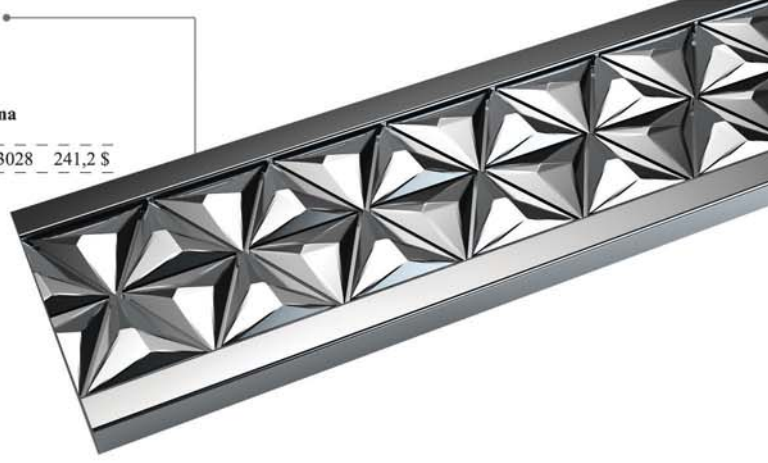

3d STAR

EBAT size	Inox Satinox	Inox Ayna Mirror	Altın Ayna Gold	Bakır Ayna Bronze
4.5 cm	PB452700127 72,5 \$	PB452440027 106,2 \$	PB452442027 125,0 \$	PB452443027 156,2 \$



3d ANGLE

EBAT size	Inox Satinox	Inox Ayna Mirror	Altın Ayna Gold	Bakır Ayna Bronze
6.5 cm	PB652700126 72,5 \$	PB652440026 106,2 \$	PB652442006 125,0 \$	PB652443026 156,2 \$



Profiline Inox - Dekorlu = 250 cm / Inox Parlak = 250 cm / Altın-Altın Ayna = 244 cm / Bakır-Bakır Ayna = 244 cm / Antrasit-Antrasit Ayna = 244 cm

MADE WITH SWAROVSKI® ELEMENTS

Ebat size	Inox Ayna mirror	Altın Ayna gold	Bakır Ayna bronze	Antrasit Ayna anthracite
8 cm	PB8024400VG 170 \$	PB8024420VG 185 \$	PB8024430VG 195 \$	PB8024440VG 205 \$

VEGA



Ebat size	Inox Ayna mirror	Altın Ayna gold	Bakır Ayna bronze	Antrasit Ayna anthracite
6 cm	PB6024400CP 175 \$	PB6024420CP 190 \$	PB6024430CP 200 \$	PB6024440CP 210 \$

CAPELLA



Profiline Inox - Dekorlu = 250 cm / Inox Parlak = 250 cm / Altın-Altın Ayna = 244 cm / Bakır-Bakır Ayna = 244 cm / Antrasit-Antrasit Ayna = 244 cm

MADE WITH SWAROVSKI® ELEMENTS

BELLATRIX



EBAT size	Inox Ayna mirror	Altın Ayna gold	Bakır Ayna bronze	Antrasit Ayna anthracite
8 cm	PB8024400VG 205 \$	PB8024420VG 225 \$	PB8024420VG 195 \$	PB8024440VG 240 \$

VENÜS



EBAT size	Inox Ayna mirror	Altın Ayna gold	Bakır Ayna bronze	Antrasit Ayna anthracite
8 cm	PB452440127 170 \$	PB452440027 185 \$	PB452442027 195 \$	PB452443027 205 \$

BUTTERFLY



EBAT size	Inox Ayna mirror	Altın Ayna gold	Bakır Ayna bronze	Antrasit Ayna anthracite
8 cm	PB452440127 170 \$	PB452440027 185 \$	PB452442027 195 \$	PB452443027 205 \$

Profiline Inox - Dekorlu = 250 cm / Inox Parlak = 250 cm / Altın-Altın Ayna = 244 cm / Bakır-Bakır Ayna = 244 cm / Antrasit-Antrasit Ayna = 244 cm

MADE WITH SWAROVSKI® ELEMENTS

Ebat size	Inox Ayna mirror	Altın Ayna gold	Bakır Ayna bronze	Antrasit Ayna anthracite
8 cm	PB8024400DN 205 \$	PB8024420DN 225 \$	PB8024430DN 230 \$	PB8024440DN 240 \$

DOLPHIN



Ebat size	Inox Ayna mirror	Altın Ayna gold	Bakır Ayna bronze	Antrasit Ayna anthracite
8 cm	PB8024400FR 170 \$	PB8024420FR 185 \$	PB8024430FR 195 \$	PB8024440FR 205 \$

FLOWER



Profiline Inox - Dekorlu = 250 cm / Inox Parlak = 250 cm / Altın-Altın Ayna = 244 cm / Bakır-Bakır Ayna = 244 cm / Antrasit-Antrasit Ayna = 244 cm

MADE WITH SWAROVSKI® ELEMENTS

Infinity S



Ebat size	Inox Ayna mirror	Altın Ayna gold	Bakır Ayna bronze	Antrasit Ayna anthracite
8 cm	PB8024400IS 205 \$	PB8024420IS 225 \$	PB8024420IS 230 \$	PB8024440IS 240 \$

Infinity R



Ebat size	Inox Ayna mirror	Altın Ayna gold	Bakır Ayna bronze	Antrasit Ayna anthracite
8 cm	PB8024400IR 205 \$	PB8024420IR 225 \$	PB8024430IR 230 \$	PB8024440IR 240 \$

Infinity B



Ebat size	Inox Ayna mirror	Altın Ayna gold	Bakır Ayna bronze	Antrasit Ayna anthracite
8 cm	PB8024400IB 205 \$	PB8024420IB 225 \$	PB8024430IB 230 \$	PB8024440IB 240 \$

Profiline Inox - Dekorlu = 250 cm / Inox Parlak = 250 cm / Altın-Altın Ayna = 244 cm / Bakır-Bakır Ayna = 244 cm / Antrasit-Antrasit Ayna = 244 cm

MADE WITH SWAROVSKI® ELEMENTS

Ebat size	Inox Ayna mirror	Altın Ayna gold	Bakır Ayna bronze	Antrasit Ayna anthracite	
8 cm	PB8024400ID	205 \$	PB8024420ID	225 \$	
			PB8024430ID	230 \$	
				PB8024440ID	240 \$

Infinity D



Ebat size	Inox Ayna mirror	Altın Ayna gold	Bakır Ayna bronze	Antrasit Ayna anthracite	
8 cm	PB8024400IF	205 \$	PB8024420IF	225 \$	
			PB8024430IF	230 \$	
				PB8024440IF	240 \$

Infinity F



Profiline Inox - Dekorlu = 250 cm / Inox Parlak = 250 cm / Altın-Altın Ayna = 244 cm / Bakır-Bakır Ayna = 244 cm / Antrasit-Antrasit Ayna = 244 cm

MADE WITH SWAROVSKI® ELEMENTS

PROFILINE 3D

R Dizayn

Ebat size	Inox- Inox Dekorlu Satinox - Decor	
4 cm	PB40250011K	50 \$

Kasablanka - S



Ebat size	Kristal Ebat size	Inox- Inox Dekorlu Satinox - Decor	
4 cm	1 cm x 1 cm Beyaz	PB40250011KS	150 \$

Kasablanka - S DIAMOND



Ebat size	Inox- Inox Dekorlu Satinox - Decor	
8,5 cm	PB85250011K	120 \$

Kasablanka - 3S



Profiline Inox - Dekorlu = 250 cm / Inox Parlak = 250 cm / Altun-Altın Ayna = 244 cm / Bakır-Bakır Ayna = 244 cm / Antrasit-Antrasit Ayna = 244 cm

MADE WITH SWAROVSKI® ELEMENTS

Ebat **Inox- Inox Dekorlu**
 size Satinox - Decor
 6 cm PB60250011K 85 \$

Kasablanka - 2S



Ebat **Inox- Inox Dekorlu**
 size Satinox - Decor
 6 cm PB60250011KS 185 \$

Kasablanka - 2S DIAMOND



Ebat **Inox- Inox Dekorlu**
 size Satinox - Decor
 8,5 cm PB85250011KS 220 \$

Kasablanka - 3S DIAMOND



Profiline Inox - Dekorlu = 250 cm / Inox Parlak = 250 cm / Altun-Altın Ayna = 244 cm / Bakır-Bakır Ayna = 244 cm / Antrasit-Antrasit Ayna = 244 cm

MADE WITH SWAROVSKI® ELEMENTS

PROFILINE 3D

R Dizayn

Lilyum S

Ebat size	Inox- Inox Dekorlu Satinox - Decor		Altın S Gold	
4 cm	PB40250011L	70 \$	PB40244212L	105 \$

Lilyum - S DIAMOND

Ebat size	Inox- Inox Dekorlu Satinox - Decor		Altın S Gold	
4 cm	PB40250011LS	170 \$	PB40244212LS	205 \$

Lilyum - 3S

Ebat size	Inox- Inox Dekorlu Satinox - Decor		Altın S Gold	
8 cm	PB80250011L3S	105 \$	PB80244212L3S	190 \$

Lilyum - 3S DIAMOND

Ebat size	Inox- Inox Dekorlu Satinox - Decor		Altın S Gold	
8 cm	PB80250011LSD	205 \$	PB80244212LSD	290 \$

Profiline Inox - Dekorlu = 270 cm / Inox Parlak = 250 cm / Altın-Altın Ayna = 244 cm / Bakır-Bakır Ayna = 244 cm / Antrasit-Antrasit Ayna = 244 cm

MADE WITH SWAROVSKI® ELEMENTS

Ebat size	Inox- Inox Dekorlu Satinox - Decor	
7 cm	PB70250101K	95 \$

Kardelen



Kardelen Diamond

Ebat size	Kristal Ebat size	Inox- Inox Dekorlu Satinox - Decor	
7 cm	1 cm x 1 cm Sahara Yeşil	PB70250101KS	195 \$



Krizantem

Ebat size	Inox Satinox	
7 cm	PB70250001K	75 \$



Krizantem Diamond

Ebat size	Kristal Ebat size	Inox Satinox	
7 cm	2,5 cm x 2,5 cm Beyaz	PB70250001KS	175 \$



Profiline Inox - Dekorlu = 270 cm / Inox Parlak = 250 cm / Altın-Altın Ayna = 244 cm / Bakır-Bakır Ayna = 244 cm / Antrasit-Antrasit Ayna = 244 cm

MADE WITH SWAROVSKI® ELEMENTS

PROFILINE 3D

R Dizayn

Ebat size	Inox Satinox
9 cm	PB90250001M 110 \$

Mimoza



Ebat size	Kristal Ebat size	Inox Satinox
9 cm	1 cm x 1 cm Sahara Yeşil	PB90250001MS 210 \$

Mimoza Diamond



Ebat size	Inox - Dekorlu Satinox - Decor
8,5 cm	PB8525001A 130 \$

Açelya



Açelya Diamond

Ebat size	Kristal Ebat size	Inox - Dekorlu Satinox - Decor	Altın S Gold
8,5 cm	1 cm x 1 cm	PB85250011AS 230 \$	PB85244212AS 190 \$



Profiline Inox - Dekorlu = 270 cm / Inox Parlak = 250 cm / Altın-Altın Ayna = 244 cm / Bakır-Bakır Ayna = 244 cm / Antrasit-Antrasit Ayna = 244 cm

MADE WITH SWAROVSKI® ELEMENTS

Ebat size	Inox Ayna mirror	Altın Ayna gold	Bakır Ayna bronze	Antrasit Ayna anthracite
4,5 cm	PB4524400DN 68 \$	PB4524420DN 82 \$	PB4524430DN 111 \$	PB4524440DN 99 \$

Dragon

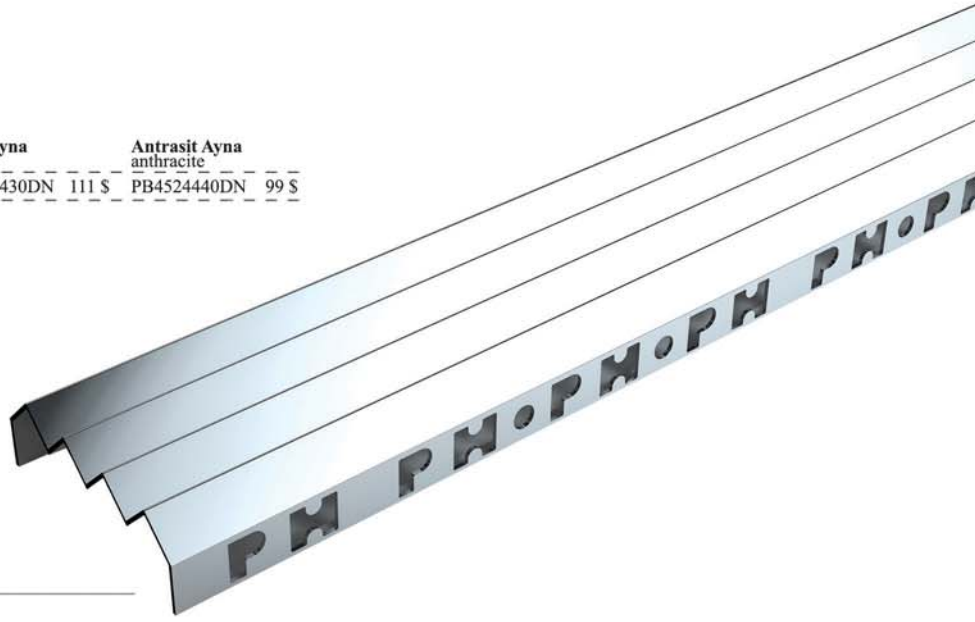

Profiline Inox - Dekorlu = 270 cm / Inox Parlak = 250 cm / Altın-Altın Ayna = 244 cm / Bakır-Bakır Ayna = 244 cm / Antrasit-Antrasit Ayna = 244 cm

MADE WITH SWAROVSKI® ELEMENTS

INOXYLINE

Paslanmaz Çelik Mozaik

Metalin ağırbaşlı güzelliğini miras alan paslanmaz çelik mozaiklerimiz ile 'Swarovski Elements' kristallerinin büyüleyici ışıltısını birleştiriyoruz.





Stainless Steel Mosaic

DECORATIVE BORDER PROFILES are manufactured from 1st grade 304 stainless steel, has 10 different surface alternatives. Profiline offered with 10,15,23,30,48 mm surface width and produced with 10 mm thickness. Lengths are 244 cm, 250 cm, 270 cm. Length are very according to surfaces alternatives.

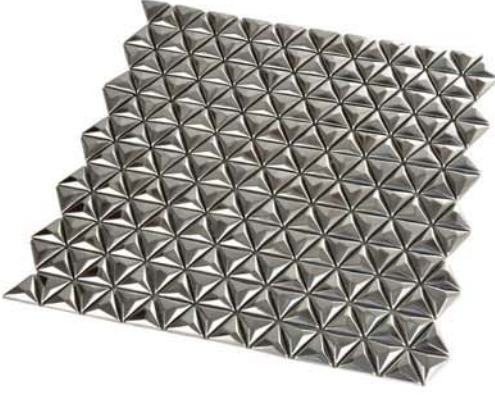

3d - STAR

Yaprak: 27,7 cm x 27,2 cm - 13,2 yaprak / m²
Bordür: 2,2 cm x 27,2 cm - 3,7 bordür / m
Mosaic Size 2,5 cm x 2,5 cm x 2,5 cm

3d - STAR

	Inox /satinox	Dekorlu /decor	Inox Ayna /mirror	Altın Ayna /gold	Bakır Ayna /bronz	Inox Dekorlu /inox decor
Yaprak	IY1300 73,75 \$	IY1311 88,50 \$	IY1355 98,75 \$	IY1366 133,00 \$	IY1377 133,00 \$	IY1301 88,50 \$
Bordür	IB1300 6,13 \$	IB1311 7,38 \$	IB1355 8,25 \$	IB1366 11,13 \$	IB1377 11,13 \$	IB1301 7,38 \$



3d - ANGLE

Yaprak: 28,8 cm x 28,8 cm - 12 yaprak / m²
Bordür: 4 cm x 28,8 cm - 3,4 bordür / m
Mosaic Size 4 cm x 4 cm

3d - ANGLE

	Inox /satinox	Dekorlu /decor	Inox Ayna /mirror	Altın Ayna /gold	Bakır Ayna /bronz	Inox Dekorlu /inox decor
Yaprak	IY1600 41,25 \$	IY1611 49,50 \$	IY1655 56,88 \$	IY1666 74,25 \$	IY1677 74,25 \$	IY1601 49,50 \$
Bordür	IB1600 5,88 \$	IB1611 7,13 \$	IB1655 8,13 \$	IB1666 10,63 \$	IB1677 10,63 \$	IB1601 7,13 \$

3D Star ve Angle serisi mozaikler, 304 kalite paslanmaz çelikten üretilmektedir. Ürünün 5 farklı yüzey renk alternatifi (Inox, Dekorlu, Inox Ayna, Altın Ayna, Bakır Ayna) mevcuttur. Renkli olan ürünler paslanmaz yüzeye pvd kaplama teknolojisi ile üretilmiştir.

Mosaic produced 304 quality stainless with 31 series and 10 different surface options, thickness is 7,5 mm. It using as a decorative wall covering. Gives decorative and a stylish look to your bathroom with the use in ceramics.



KASABLANKA

Yaprak: 27,4 cm x 27,4 cm - 13,2 yaprak / m²
Bordür: 2,1 cm x 27,4 cm - 3,7 bordür / m
Mosaic Size 2,1 cm x 2,1 cm - 2,1 cm x 6,7 cm

Kasablanka

	Inox /satinox		Dekorlu /decor		Altın /gold		Bakır /bronze		Antrasit /anthracite		Inox Dekorlu /inox decor		Dekorlu Inox /decor inox	
Yaprak	IY2700	26,25 \$	IY2711	31,25 \$	IY2722	48,25 \$	IY2733	48,25 \$	IY2744	48,25 \$	IY2701	31,25 \$	IY2710	31,25 \$
Bordür	IB2700	2,19 \$	IB2711	2,63 \$	IB2722	4,00 \$	IB2733	4,00 \$	IB2744	4,00 \$	IB2701	2,63 \$	IB2710	2,63 \$



STARLIÇE

Yaprak: 27,4 cm x 27,4 cm - 13,2 yaprak / m²
Bordür: 2,1 cm x 27,4 cm - 3,7 bordür / m
Mosaic Size 2,1 cm x 2,1 cm - 2,1 cm x 6,7 cm

Starlıçe

	Inox /satinox		Dekorlu /decor		Altın /gold		Bakır /bronze		Antrasit /anthracite		Inox Dekorlu /inox decor		Dekorlu Inox /decor inox	
Yaprak	IY4800	26,88 \$	IY4811	32,25 \$	IY4822	48,25 \$	IY4833	48,25 \$	IY4844	48,25 \$	IY4801	32,25 \$	IY4810	32,25 \$
Bordür	IB4800	9,00 \$	IB4811	10,75 \$	IB4822	16,06 \$	IB4833	16,06 \$	IB4844	16,06 \$	IB4801	10,75 \$	IB4810	10,75 \$

Kazablanka ve Starlıçe serisi mozaikler, 304 kalite paslanmaz çelikten üretilmektedir. Ürünün 5 farklı yüzey renk alternatifi (Inox, Dekorlu, Inox Ayna, Altın Ayna, Bakır Ayna) mevcuttur. Renkli olan ürünler paslanmaz yüzeye pvd kaplama teknolojisi ile üretilmiştir.

Mosaic produced 304 quality stainless with 31 series and 10 different surface options, thickness is 7,5 mm. It using as a decorative wall covering. Gives decorative and a stylish look to your bathroom with the use in ceramics.



MİMOZA

Yaprak: 27,4 cm x 27,4 cm - 13,2 yaprak / m²
 Dikey Bordür: 27,4 cm x 6,7 cm - 3,7 bordür / m
 Yatay Bordür: 2,1 cm x 27,4 cm - 3,7 bordür / m
 Mosaic Size 2,1 cm x 6,7 cm

Mimoza

	Inox /satinox	Dekorlu /decor	Altın /gold	Bakır /bronz	Antrasit /anthracite	Inox Dekorlu /inox decor						
Yaprak	IY3300	25,63 \$	IY3311	30,63 \$	IY3322	46,25 \$	IY3333	46,25 \$	IY3344	46,25 \$	IY3301	30,63 \$
D.Bordür	IB3300	6,38 \$	IB3311	7,75 \$	IB3322	11,56 \$	IB3333	11,56 \$	IB3344	11,56 \$	IB3301	7,75 \$
Y.Bordür	IB3400	2,13 \$	IB3411	2,63 \$	IB3422	3,88 \$	IB3433	3,88 \$	IB3444	3,88 \$	IB3401	2,63 \$



FREZYA

Yaprak: 29,8 cm x 29,8 cm - 11,2 yaprak / m²
 Bordür: 4,8 cm x 29,8 cm - 3,4 bordür / m
 Mosaic Size 4,8 cm x 4,8 cm

Frezya

	Inox /satinox	Dekorlu /decor	Altın /gold	Bakır /bronz	Antrasit /anthracite	Inox Dekorlu /inox decor						
Yaprak	IY1200	21,25 \$	IY1211	25,63 \$	IY1222	38,25 \$	IY1233	38,25 \$	IY1244	38,25 \$	IY1201	25,63 \$
Bordür	IB1200	3,54 \$	IB1211	4,28 \$	IB1222	6,38 \$	IB1233	6,38 \$	IB1244	6,38 \$	IB1201	4,28 \$

Mimoza ve Frezya serisi mozaikler, 304 kalite paslanmaz çelikten üretilmektedir. Ürünün 5 farklı yüzey renk alternatifi (Inox, Dekorlu, Inox Ayna, Altın Ayna, Bakır Ayna) mevcuttur. Renkli olan ürünler paslanmaz yüzeye pvd kaplama teknolojisi ile üretilmiştir.

Mosaic produced 304 quality stainless with 31 series and 10 different surface options, thickness is 7,5 mm. It using as a decorative wall covering. Gives decorative and a stylish look to your bathroom with the use in ceramics.



LİLYUM

Yaprak: 27,4 cm x 27,4 cm - 13,2 yaprak / m²
Bordür: 2,1 cm x 27,4 cm - 3,7 bordür / m
Mosaic Size 2,1 cm x 2,1 cm

Lilyum

	Inox /satinox	Dekorlu /decor	Altın /gold	Bakır /bronz	Antrasit /anthracite	Inox Dekorlu /inox decor
Yaprak	IY3900 30,00 \$	IY3911 35,63 \$	IY3922 54,00 \$	IY3933 54,00 \$	IY3944 54,00 \$	IY3901 35,63 \$
Bordür	IB3900 2,50 \$	IB3911 3,00 \$	IB3922 4,50 \$	IB3933 4,50 \$	IB3944 4,50 \$	IB3901 3,00 \$



KAMELYA

Yaprak: 27,4 cm x 27,4 cm - 13,2 yaprak / m²
Bordür: 2,1 cm x 27,4 cm - 3,7 bordür / m
Mosaic Size 2,1 cm x 6,7 cm

Kamelya

	Inox /satinox	Dekorlu /decor	Altın /gold	Bakır /bronz	Antrasit /anthracite	Inox Dekorlu /inox decor
Yaprak	IY3000 25,63 \$	IY3011 30,63 \$	IY3022 46,25 \$	IY3033 46,25 \$	IY3044 46,25 \$	IY3001 30,63 \$
Bordür	IB3000 2,13 \$	IB3011 2,63 \$	IB3022 3,88 \$	IB3033 3,88 \$	IB3044 3,88 \$	IB3001 2,63 \$

Lilyum ve Kamelya serisi mozaikler, 304 kalite paslanmaz çelikten üretilmektedir. Ürünün 5 farklı yüzey renk alternatifi (Inox, Dekorlu, Inox Ayna, Altın Ayna, Bakır Ayna) mevcuttur. Renkli olan ürünler paslanmaz yüzeye pvd kaplama teknolojisi ile üretilmiştir.

Mosaic produced 304 quality stainless with 31 series and 10 different surface options, thickness is 7,5 mm. It using as a decorative wall covering. Gives decorative and a stylish look to your bathroom with the use in ceramics.

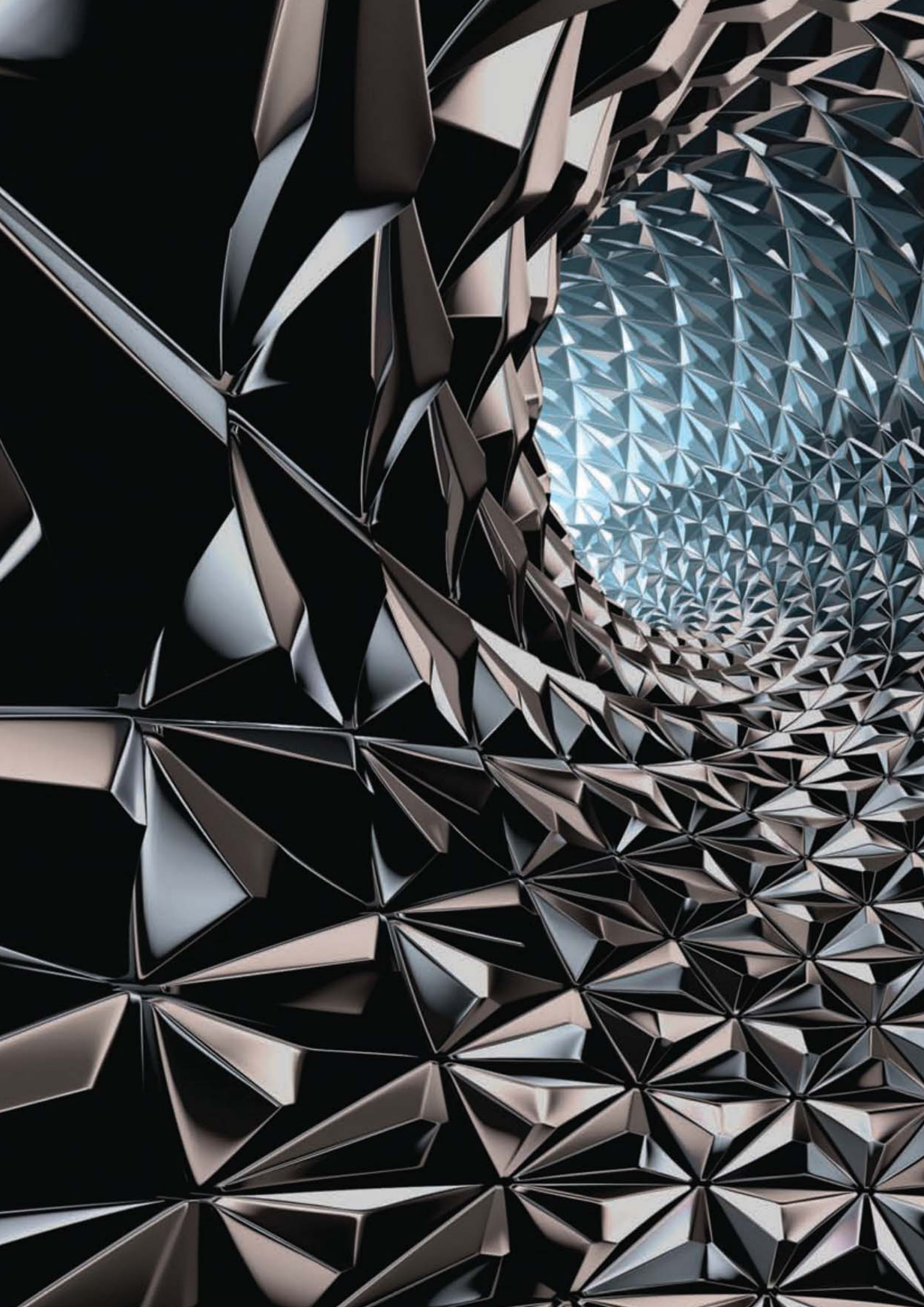



3d STAR

INOXYLINE 3D

R Dizayn



Nilüfer

NİLÜFER

Yaprak: 29,8 cm x 30,2 cm - 11,2 yaprak / m²
Dikey Bordür: 29,8 cm x 15 cm - 3,4 bordür / m
Yatay Bordür: 4,8 cm x 30,2 cm - 3,4 bordür / m
Mosaic Size 4,8 cm x 10 cm

	Inox /satinox	Dekorlu /decor	Altın /gold	Bakır /bronz	Antrasit /anthracite	Inox Dekorlu /inox decor	Dekorlu Inox /decor inox
Yaprak	IY7200 21,25 \$	IY7211 25,63 \$	IY7222 39,75 \$	IY7233 39,75 \$	IY7244 39,75 \$	IY7201 25,63 \$	IY7210 25,63 \$
D.Bordür	IB7200 10,63 \$	IB7211 12,88 \$	IB7222 19,88 \$	IB7233 19,88 \$	IB7244 19,88 \$	IB7201 12,88 \$	IB7210 12,88 \$
Y.Bordür	IB7300 3,54 \$	IB7311 4,28 \$	IB7322 6,63 \$	IB7333 6,63 \$	IB7344 6,63 \$	IB7301 4,28 \$	IB7310 4,28 \$



Krizantem

KRİZANTEM

Yaprak: 29,8 cm x 30,4 cm - 11,2 yaprak / m²
Bordür: 4,8 cm x 30,4 cm - 3,4 bordür / m
Mosaic Size 4,8 cm x 10 cm

	Inox /satinox	Dekorlu /decor	Altın /gold	Bakır /bronz	Antrasit /anthracite	Inox Dekorlu /inox decor
Yaprak	IY4500 22,50 \$	IY4511 26,88 \$	IY4522 40,50 \$	IY4533 40,50 \$	IY4544 40,50 \$	IY4501 26,8 \$
Bordür	IB4500 3,50 \$	IB4511 4,25 \$	IB4522 6,75 \$	IB4533 6,75 \$	IB4544 6,75 \$	IB4501 4,25 \$

Nilüfer ve Krizantem serisi mozaikler, 304 kalite paslanmaz çelikten üretilmektedir. Ürünün 5 farklı yüzey renk alternatifi (Inox, Dekorlu, Inox Ayna, Altın Ayna, Bakır Ayna) mevcuttur. Renkli olan ürünler paslanmaz yüzeye pvd kaplama teknolojisi ile üretilmiştir.

Mosaic produced 304 quality stainless with 31 series and 10 different surface options, thickness is 7,5 mm. It using as a decorative wall covering. Gives decorative and a stylish look to your bathroom with the use in ceramics.



SİNADA

Yaprak: 27 cm x 27 cm - 13,5 yaprak / m²
Bordür: 1,5 cm x 27 cm - 3,7 bordür / m
Mosaic Size 1,5 cm x 1,5 cm

Sinada

	Inox /satinox	Dekorlu /decor	Altın /gold	Bakır /bronz	Antrasit /anthracite	Inox Dekorlu /inox decor
Yaprak	IY4200 41,25 \$	IY4211 49,38 \$	IY4222 73,63 \$	IY4233 73,63 \$	IY4244 73,63 \$	IY4201 49,38 \$
Bordür	IB4200 2,50 \$	IB4211 3,00 \$	IB4222 4,63 \$	IB4233 4,63 \$	IB4244 4,63 \$	IB4201 3,00 \$



MANOLYA

Yaprak: 27 cm x 27 cm - 13,5 yaprak / m²
Bordür: 1,5 cm x 27 cm - 3,7 bordür / m
Mosaic Size 1,5 cm x 1,5 cm

Manolya

	Inox /satinox	Dekorlu /decor	Altın /gold	Bakır /bronz	Antrasit /anthracite	Inox Dekorlu /inox decor
Yaprak	IY6900 41,25 \$	IY6911 49,38 \$	IY6922 73,63 \$	IY6933 73,63 \$	IY6944 73,63 \$	IY6901 49,38 \$
Bordür	IB6900 2,50 \$	IB6911 3,00 \$	IB6922 4,63 \$	IB6933 4,63 \$	IB6944 4,63 \$	IB6901 3,00 \$

Sinada ve Manolya serisi mozaikler, 304 kalite paslanmaz çelikten üretilmektedir. Ürünün 5 farklı yüzey renk alternatifi (Inox, Dekorlu, Inox Ayna, Altın Ayna, Bakır Ayna) mevcuttur. Renkli olan ürünler paslanmaz yüzeye pvd kaplama teknolojisi ile üretilmiştir.

Mosaic produced 304 quality stainless with 31 series and 10 different surface options, thickness is 7,5 mm. It using as a decorative wall covering. Gives decorative and a stylish look to your bathroom with the use in ceramics.

INOXYLINE 3D

R Dizayn



PAPATYA

Yaprak: 25 cm x 26,6 cm - 15,1 yaprak / m²
1. Bordür: 4,8 cm x 26,6 cm - 3,8 bordür / m
2. Bordür: 8,2 cm x 26,6 cm - 3,8 bordür / m
Mosaic Size 1,5 cm x 1,5 cm - 4,8 cm x 4,8 cm

Papatya

	Inox /satinox	Dekorlu /decor	Altın /gold	Bakır /bronz	Antrasit /anthracite	Inox Dekorlu /inox decor	Dekorlu Inox /decor inox
Yaprak	IY6300 28,38 \$	IY6311 34,13 \$	IY6322 50,75 \$	IY6333 50,75 \$	IY6344 50,75 \$	IY6301 34,13 \$	IY6310 34,13 \$
1.Bordür	IB6300 4,38 \$	IB6311 5,25 \$	IB6322 7,75 \$	IB6333 7,75 \$	IB6344 7,75 \$	IB6301 5,25 \$	IB6310 5,25 \$
2.Bordür	IB6400 9,50 \$	IB6411 11,38 \$	IB6422 17,00 \$	IB6433 17,00 \$	IB6444 17,00 \$	IB6401 11,38 \$	IB6410 11,38 \$



VIOLET

Yaprak: 29,8 cm x 30,4 cm - 11,2 yaprak / m²
Bordür: 29,8 cm x 10 cm - 3,4 bordür / m
Mosaic Size 4,8 cm x 10 cm

Violet

	Inox /satinox	Dekorlu /decor	Altın /gold	Bakır /bronz	Antrasit /anthracite	Inox Dekorlu /inox decor
Yaprak	IY2400 22,50 \$	IY2411 26,88 \$	IY2422 40,50 \$	IY2433 40,50 \$	IY2444 40,50 \$	IY2401 26,88 \$
Bordür	IB2400 7,50 \$	IB2411 9,00 \$	IB2422 13,50 \$	IB2433 13,50 \$	IB2444 13,50 \$	IB2401 9,00 \$

Papatya ve Violet serisi mozaikler, 304 kalite paslanmaz çelikten üretilmektedir. Ürünün 5 farklı yüzey renk alternatifi (Inox, Dekorlu, Inox Ayna, Altın Ayna, Bakır Ayna) mevcuttur. Renkli olan ürünler paslanmaz yüzeye pvd kaplama teknolojisi ile üretilmiştir.

Mosaic produced 304 quality stainless with 31 series and 10 different surface options, thickness is 7,5 mm. It using as a decorative wall covering. Gives decorative and a stylish look to your bathroom with the use in ceramics.



FULYA

Yaprak: 26,6 cm x 30,4 cm - 12,4 yaprak / m²
1. Bordür: 6,5 cm x 30,4 cm - 3,4 bordür / m
2. Bordür: 8,2 cm x 30,4 cm - 3,4 bordür / m
Mosaic Size 1,5 cm x 10 cm - 4,8 cm x 10 cm

Fulya

	Inox /satinox	Dekorlu /decor	Altın /gold	Bakır /bronz	Antrasit /anthracite	Inox Dekorlu /inox decor	Dekorlu Inox /decor inox
Yaprak	IY8100 22,50 \$	IY8111 27,00 \$	IY8122 41,88 \$	IY8133 41,88 \$	IY8144 41,88 \$	IY8101 27,00\$	IY8110 27,00 \$
1.Bordür	IB8100 5,63 \$	IB8111 6,75 \$	IB8122 10,44 \$	IB8133 10,44 \$	IB8144 10,44 \$	IB8101 6,75 \$	IB8110 6,75 \$
2.Bordür	IB8200 7,63 \$	IB8211 9,19 \$	IB8222 14,13 \$	IB8233 14,13 \$	IB8244 14,13 \$	IB8201 9,19 \$	IB8210 9,19 \$



İRİS

Yaprak: 27 cm x 30,4 cm - 12,2 yaprak / m²
Bordür: 1,5 cm x 30,4 cm - 3,4 bordür / m
Mosaic Size 1,5 cm x 10 cm

İris

	Inox /satinox	Dekorlu /decor	Altın /gold	Bakır /bronz	Antrasit /anthracite	Inox Dekorlu /inox decor
Yaprak	IY7500 32,5 \$	IY7511 39,00 \$	IY7522 58,88 \$	IY7533 58,88 \$	IY7544 58,88 \$	IY7501 39,00 \$
Bordür	IB7500 2,04 \$	IB7511 2,44 \$	IB7522 3,69 \$	IB7533 3,69 \$	IB7544 3,69 \$	IB7501 2,44 \$

Fulya ve İris serisi mozaikler, 304 kalite paslanmaz çelikten üretilmektedir. Ürünün 5 farklı yüzey renk alternatifi (Inox, Dekorlu, Inox Ayna, Altın Ayna, Bakır Ayna) mevcuttur. Renkli olan ürünler paslanmaz yüzeye pvd kaplama teknolojisi ile üretilmiştir.

Mosaic produced 304 quality stainless with 31 series and 10 different surface options, thickness is 7,5 mm. It using as a decorative wall covering. Gives decorative and a stylish look to your bathroom with the use in ceramics.

INOXYLINE 3D

R Dizayn



AÇELYA

Yaprak: 26,6 cm x 26,6 cm - 14,2 yaprak / m²
Bordür: 6,5 cm x 26,6 cm - 3,8 bordür / m
Mosaic Size 1,5 cm x 1,5 cm - 4,8 cm x 4,8 cm

Açelya

	Inox /satinox	Dekorlu /decor	Altın /gold	Bakır /bronz	Antrasit /anthracite	Inox Dekorlu /inox decor	Dekorlu Inox /decor inox
Yaprak	IY6600 27,50 \$	IY6611 33,00 \$	IY6622 49,25 \$	IY6633 49,25 \$	IY6644 49,25 \$	IY6601 33,00 \$	IY6601 33,00 \$
Bordür	IB6600 6,88 \$	IB6611 8,25 \$	IB6622 12,31 \$	IB6633 12,31 \$	IB6644 12,31 \$	IB6601 8,25 \$	IB6601 8,25 \$



LEYLAK

Yaprak: 27 cm x 30,4 cm - 12,2yaprak / m²
Bordür: 1,5 cm x 30,4 cm - 3,4 bordür / m
Mosaic Size 1,5 cm x 10 cm

Leylak

	Inox /satinox	Dekorlu /decor	Altın /gold	Bakır /bronz	Antrasit /satinox	Inox Dekorlu /inox decor
Yaprak	IY9000 32,50 \$	IY9011 39,00 \$	IY9022 58,88 \$	IY9033 58,88 \$	IY9044 58,88 \$	IY9001 39,00 \$
Bordür	IB9000 2,04 \$	IB9011 2,44 \$	IB9022 3,69 \$	IB9033 3,69 \$	IB9044 3,69 \$	IB9001 2,44 \$

Açelya ve Leylak serisi mozaikler, 304 kalite paslanmaz çelikten üretilmektedir. Ürünün 5 farklı yüzey renk alternatifi (Inox, Dekorlu, Inox Ayna, Altın Ayna, Bakır Ayna) mevcuttur. Renkli olan ürünler paslanmaz yüzeye pvd kaplama teknolojisi ile üretilmiştir.

Mosaic produced 304 quality stainless with 31 series and 10 different surface options, thickness is 7,5 mm. It using as a decorative wall covering. Gives decorative and a stylish look to your bathroom with the use in ceramics.



Kardelen

KARDELEN

Yaprak: 29,8 cm x 30,4 cm - 11 yaprak / m²
 1. Bordür: 4,8 cm x 30,4 cm - 3,4 bordür / m
 2. Bordür: 4,8 cm x 30,4 cm - 3,4 bordür / m
 Mosaic Size 1,5 cm x 10 cm - 4,8 cm x 10 cm

	Inox /satinox	Dekorlu /decor	Altın /gold	Bakır /bronz	Antrasit /anthracite	Inox Dekorlu /inox decor	Dekorlu Inox /decor inox
Yaprak	IY7800 29,38 \$	IY7811 35,25 \$	IY7822 53,28 \$	IY7833 53,38 \$	IY7844 53,38 \$	IY7801 35,25 \$	IY7810 35,25 \$
1.Bordür	IB7800 4,40 \$	IB7811 5,28 \$	IB7822 8,19 \$	IB7833 8,19 \$	IB7844 8,19 \$	IB7801 5,28 \$	IB7810 5,28 \$
2.Bordür	IB7900 5,28 \$	IB7911 6,25 \$	IB7922 9,63 \$	IB7933 9,63 \$	IB7944 9,63 \$	IB7901 6,25 \$	IB7910 6,25 \$



Defne

DEFNE

Yaprak: 27,4 cm x 27,4 cm - 13,2 yaprak / m²
 Bordür: 2,1 cm x 27,4 cm - 3,7 bordür / m
 Mosaic Size 2,5 cm x 2,5 cm

	Inox /satinox	Dekorlu /decor	Altın /gold	Bakır /bronz	Antrasit /anthracite	Inox Dekorlu /inox decor
Yaprak	IY9300 29,00 \$	IY9311 34,80 \$	IY9322 52,25 \$	IY9333 52,25 \$	IY9344 52,25 \$	IY9301 31,90 \$
Bordür	IB9300 2,90 \$	IB9311 3,48 \$	IB9322 5,23 \$	IB9333 5,23 \$	IB9344 5,23 \$	IB9301 3,19 \$

Kardelen ve Defne serisi mozaikler, 304 kalite paslanmaz çelikten üretilmektedir. Ürünün 5 farklı yüzey renk alternatifi (Inox, Dekorlu, Inox Ayna, Altın Ayna, Bakır Ayna) mevcuttur. Renkli olan ürünler paslanmaz yüzeye pvd kaplama teknolojisi ile üretilmiştir.

Mosaic produced 304 quality stainless with 31 series and 10 different surface options, thickness is 7,5 mm. It using as a decorative wall covering. Gives decorative and a stylish look to your bathroom with the use in ceramics.



VADI ISTANBUL 1. ETAP



SEA PEARL



YEDI MAVI



TEMA ISTANBUL



DAP VAZO KULE



5. LEVENT



PRUVA 34



STRADA BAHCESEHIR



PIAZZA RONESANS MALTEPE



SKYLAND



VADI ISTANBUL 3. ETAP



KUZU KUMRU ANKARA



BATI MAHAL VILLALARI



ARTAŞ ATAKENT 4



AYAZMA KONUTLARI



AVRUPARK



BAHCESEHIR KONAKLARI



NIDAPARK KAYASEHIR



EVIM KADIKOY



EMAX KENT PLUS



ARTAS ATAKOY



KALE DAIRE KARTAL



1071 KADIKOY



GARANTI KOZA



ELIT CONCEPT



BAYRAMPASA KENTSEL DONUSUM



KARAT 34



VADITEPE GOLEVLERI



GOL PANOROMA



KALE TOPKAPI



TOYA MODA



ECLIPSE MASLA



ORYAPARK



DAP BURGU KULE



CAPITOL AVM



TAKSIM PETEK RESIDENCE



CAROUSEL AVM



HARVEY NICHOLS



TUI BLUE OTEL ANTALYA



SAHIL KONAKLARI



ONAY LIFE RESIDENCE



LUXERA RESIDENCE



LAVINYA CITY



ALETTA MOONPARK



ELIT WORLD OTEL



ABUDHABI RIXOS OTEL



TRABZON MARINCITY



UMUTKENT BURSA



EGAL ISTANBUL



ARWEN MERLIN



BAKIRKOY CITY1



BAKIRKOY CITY2



CORDELLA KARTAL



DIA MARE



EVIM YUKSEK DAG



KARTAL 101



OFTON KOSUYOLU



OFTON YALIKAVAK



OFTON SISLI



OFTON BEYKOZ



OFTON KANDILLI



DAP Z OFIS



DAP TANGO KULE



ATATURK HAVALIMANI



PH Dizayn Yapı Ürünleri San. ve Tic. Ltd. Şti.

Aydınevler Mahallesi Preveze Sokak E-5 Yan Yol No: 3/6 Maltepe / İSTANBUL / TÜRKİYE
T. +90 216 388 7880 (pbx)
F. +90 216 388 7814

www.phdizayn.com / info@phdizayn.com

2018



PH Dizayn Yapı Ürünleri San. ve Tic. Ltd. Şti.

Aydınevler Mahallesi Preveze Sokak E-5 Yan Yol No: 3/6 Maltepe / İSTANBUL / TÜRKİYE
T. +90 216 388 7880 (pbx)
F. +90 216 388 7814

www.phdizayn.com / info@phdizayn.com

2018